

# User's Manual

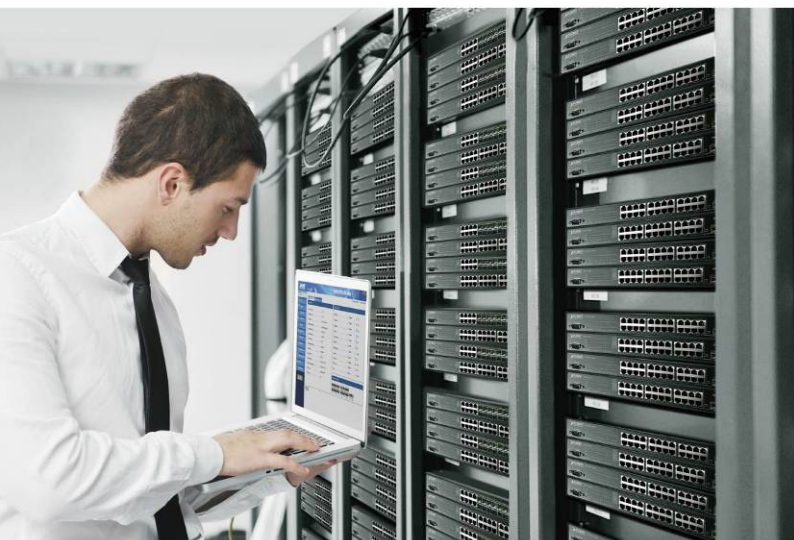

## Industrial L2/L4 Managed Gigabit Switch with 4-Port 802.3at PoE+

▶ IGS-4215-4P4T/IGS-4215-4P4T2S



## Trademarks

Copyright © PLANET Technology Corp. 2016.

Contents are subject to revision without prior notice.

PLANET is a registered trademark of PLANET Technology Corp. All other trademarks belong to their respective owners.

## Disclaimer

PLANET Technology does not warrant that the hardware will work properly in all environments and applications, and makes no warranty and representation, either implied or expressed, with respect to the quality, performance, merchantability, or fitness for a particular purpose. PLANET has made every effort to ensure that this User's Manual is accurate; PLANET disclaims liability for any inaccuracies or omissions that may have occurred.

Information in this User's Manual is subject to change without notice and does not represent a commitment on the part of PLANET. PLANET assumes no responsibility for any inaccuracies that may be contained in this User's Manual. PLANET makes no commitment to update or keep current the information in this User's Manual, and reserves the right to make improvements to this User's Manual and/or to the products described in this User's Manual, at any time without notice.

If you find information in this manual that is incorrect, misleading, or incomplete, we would appreciate your comments and suggestions.

## FCC Warning

This equipment has been tested and found to comply with the limits for a Class A digital device, pursuant to Part 15 of the FCC Rules. These limits are designed to provide reasonable protection against harmful interference when the equipment is operated in a commercial environment. This equipment generates, uses, and can radiate radio frequency energy and, if not installed and used in accordance with the Instruction manual, may cause harmful interference to radio communications. Operation of this equipment in a residential area is likely to cause harmful interference in which case the user will be required to correct the interference at his own expense.

## CE Mark Warning

This is a Class A product. In a domestic environment, this product may cause radio interference, in which case the user may be required to take adequate measures.

## Energy Saving Note of the Device

This power required device does not support Standby mode operation. For energy saving, please remove the power cable to disconnect the device from the power circuit. In view of saving the energy and reducing the unnecessary power consumption, it is strongly suggested to remove the power connection for the device if this device is not intended to be active.

## WEEE Warning



To avoid the potential effects on the environment and human health as a result of the presence of hazardous substances in electrical and electronic equipment, end users of electrical and electronic equipment should understand the meaning of the crossed-out wheeled bin symbol. Do not dispose of WEEE as unsorted municipal waste and have to collect such WEEE separately.

## Revision

PLANET IGS-4215 Series User's Manual

MODELS: IGS-4215-4P4T and IGS-4215-4P4T2S

REVISION: 1.0 (December, 2015)

Part No: EM-IGS-4215-series\_v1.0

## TABLE OF CONTENTS

<b>1. INTRODUCTION</b> .....	<b>10</b>
<b>1.1 Packet Contents</b> .....	<b>10</b>
<b>1.2 Product Description</b> .....	<b>11</b>
<b>1.3 How to Use This Manual</b> .....	<b>16</b>
<b>1.4 Product Features</b> .....	<b>17</b>
<b>1.5 Product Specifications</b> .....	<b>20</b>
<b>2. INSTALLATION</b> .....	<b>24</b>
<b>2.1 Hardware Description</b> .....	<b>24</b>
2.1.1 Physical Dimensions .....	24
2.1.2 Switch Front Panel .....	25
2.1.3 LED Indications .....	27
2.1.4 Switch Upper Panel .....	29
2.1.5 Wiring the Power Inputs .....	29
2.1.6 Wiring the Faulty Alarm Contact .....	30
<b>2.2 Installing the Industrial Managed Switch</b> .....	<b>31</b>
2.2.1 Installation Steps .....	31
2.2.2 DIN-rail Mounting .....	32
2.2.3 Wall Mount Plate Mounting .....	34
2.2.4 Installing the SFP transceiver (For IGS-4215-4P4T2S) .....	35
2.2.5 Removing the SFP Transceiver (For IGS-4215-4P4T2S) .....	38
<b>3. SWITCH MANAGEMENT</b> .....	<b>39</b>
<b>3.1 Requirements</b> .....	<b>39</b>
<b>3.2 Management Access Overview</b> .....	<b>40</b>
<b>3.3 Administration Console</b> .....	<b>41</b>
<b>3.4 Web Management</b> .....	<b>42</b>
<b>3.5 SNMP-based Network Management</b> .....	<b>43</b>
<b>3.6 PLANET Smart Discovery Utility</b> .....	<b>43</b>
<b>4. WEB CONFIGURATION</b> .....	<b>45</b>
<b>4.1 Main Web Page</b> .....	<b>48</b>
4.1.1 Save Button .....	49
4.1.2 Configuration Manager .....	50
4.1.2.1 Saving Configuration .....	51
<b>4.2 System</b> .....	<b>52</b>
4.2.1 System Information .....	52
4.2.2 IP Configurations .....	54

4.2.3 IPv6 Configuration .....	56
4.2.4 User Configuration .....	58
4.2.5 Time Settings .....	59
4.2.5.1 System Time .....	59
4.2.5.2 SNTP Server Settings .....	62
4.2.6 Log Management .....	63
4.2.6.1 Local Log .....	63
4.2.6.2 Local Log .....	64
4.2.6.3 Remote Syslog .....	65
4.2.6.4 Log Message .....	67
4.2.7 SNMP Management .....	69
4.2.7.1 SNMP Overview .....	69
4.2.7.2 SNMP Setting .....	70
4.2.7.3 SNMP View .....	71
4.2.7.4 SNMP Access Group .....	72
4.2.7.5 SNMP Community .....	74
4.2.7.6 SNMP User .....	75
4.2.7.7 SNMPv1, 2 Notification Recipients .....	77
4.2.7.8 SNMPv3 Notification Recipients .....	78
4.2.7.9 SNMP Engine ID .....	80
4.2.7.10 SNMP Remote Engine ID .....	81
4.2.8 Fault Alarm Configuration .....	82
<b>4.3 Port Management.....</b>	<b>83</b>
4.3.1 Port Configuration .....	83
4.3.2 Port Counters .....	85
4.3.3 Bandwidth Utilization .....	90
4.3.4 Port Mirroring .....	91
4.3.5 Jumbo Frame .....	93
4.3.6 Port Error Disabled Configuration .....	94
4.3.7 Port Error Disabled Status .....	96
4.3.8 Protected Ports .....	96
4.3.9 EEE .....	99
4.3.10 SFP Module Information .....	100
4.3.10.1 SFP Module Status .....	100
4.3.10.1 SFP Module Detail Status .....	102
<b>4.4 Link Aggregation.....</b>	<b>103</b>
4.4.1 LAG Setting .....	105
4.4.2 LAG Management .....	106
4.4.3 LAG Port Setting .....	107
4.4.4 LACP Setting .....	109



4.4.5 LACP Port Setting.....	110
4.4.6 LAG Status .....	111
<b>4.5 VLAN .....</b>	<b>114</b>
4.5.1 VLAN Overview .....	114
4.5.2 IEEE 802.1Q VLAN .....	115
4.5.3 Management VLAN .....	119
4.5.4 Create VLAN .....	120
4.5.5 Interface Settings.....	121
4.5.6 Port to VLAN.....	125
4.5.7 Port VLAN Membership .....	126
4.5.8 Protocol VLAN Group Setting .....	127
4.5.9 Protocol VLAN Port Setting .....	129
4.5.10 GVRP Setting .....	130
4.5.11 GVRP Port Setting .....	132
4.5.12 GVRP VLAN .....	133
4.5.13 GVRP Statistics .....	134
4.5.14 VLAN Setting Example: .....	136
4.5.14.1 Two Separate 802.1Q VLANs.....	136
4.5.14.2 VLAN Trunking between two 802.1Q aware switches .....	139
<b>4.6 Spanning Tree Protocol.....</b>	<b>142</b>
4.6.1 Theory .....	142
4.6.2 STP Global Settings .....	149
4.6.3 STP Port Setting .....	151
4.6.4 CIST Instance Setting .....	154
4.6.5 CIST Port Setting.....	156
4.6.6 MST Instance Configuration .....	158
4.6.7 MST Port Setting .....	160
4.6.8 STP Statistics .....	162
<b>4.7 Multicast .....</b>	<b>163</b>
4.7.1 Properties .....	163
4.7.2 IGMP Snooping .....	164
4.7.2.1 IGMP Setting .....	168
4.7.2.2 IGMP Querier Setting .....	170
4.7.2.3 IGMP Static Group.....	171
4.7.2.4 IGMP Group Table .....	172
4.7.2.5 IGMP Router Setting .....	173
4.7.2.6 IGMP Router Table .....	174
4.7.2.7 IGMP Forward All .....	175
4.7.3 IGMP Snooping Statics .....	176
4.7.4 MLD Snooping.....	178

4.7.4.1 MLD Setting.....	178
4.7.4.2 MLD Static Group .....	180
4.7.4.3 MLD Group Table .....	181
4.7.4.4 MLD Router Setting.....	181
4.7.4.5 MLD Router Table.....	183
4.7.4.6 MLD Forward All .....	184
4.7.5 MLD Snooping Statics .....	185
4.7.6 Multicast Throttling Setting .....	187
4.7.7 Multicast Filter .....	188
4.7.7.1 Multicast Profile Setting.....	189
4.7.7.2 IGMP Filter Setting .....	191
4.7.7.3 MLD Filter Setting.....	192
<b>4.8 Quality of Service.....</b>	<b>193</b>
4.8.1 Understanding QoS .....	193
4.8.2 General.....	194
4.8.2.1 QoS Properties .....	194
4.8.2.2 QoS Port Settings.....	195
4.8.2.3 Queue Settings.....	196
4.8.2.4 CoS Mapping.....	197
4.8.2.5 DSCP Mapping.....	199
4.8.2.6 IP Precedence Mapping .....	200
4.8.3 QoS Basic Mode.....	202
4.8.3.1 Global Settings .....	202
4.8.3.2 Port Settings.....	203
4.8.4 Rate Limit .....	204
4.8.4.1 Ingress Bandwidth Control .....	204
4.8.4.2 Egress Bandwidth Control .....	205
4.8.4.3 Egress Queue .....	206
4.8.5 Voice VLAN .....	207
4.8.5.1 Introduction to Voice VLAN.....	207
4.8.5.2 Properties .....	208
4.8.5.3 Telephony OUI MAC Setting.....	209
4.8.5.4 Telephony OUI Port Setting .....	211
<b>4.9 Security.....</b>	<b>213</b>
4.9.1 802.1X.....	213
4.9.1.1 Understanding IEEE 802.1X Port-based Authentication.....	214
4.9.1.2 802.1X Setting.....	217
4.9.1.3 802.1X Port Setting .....	218
4.9.1.4 Guest VLAN Setting .....	220
4.9.1.5 Authenticated Host .....	222

4.9.2 RADIUS Server .....	223
4.9.3 TACACS+ Server.....	226
4.9.4 AAA .....	228
4.9.4.1 Login List .....	229
4.9.4.2 Enable List.....	230
4.9.5 Access .....	231
4.9.5.1 Telnet.....	231
4.9.5.2 SSH.....	232
4.9.5.3 HTTP.....	234
4.9.5.4 HTTPs .....	235
4.9.6 Management Access Method .....	236
4.9.6.1 Profile Rules .....	236
4.9.6.2 Access Rules.....	238
4.9.7 DHCP Snooping .....	239
4.9.7.1 DHCP Snooping Overview .....	239
4.9.7.2 Global Setting.....	241
4.9.7.3 DHCP Snooping VLAN Setting.....	242
4.9.7.4 Port Setting.....	243
4.9.7.5 Statistics .....	245
4.9.7.6 Database Agent .....	246
4.9.7.7 Rate Limit .....	248
4.9.7.8 Option82 Global Setting .....	249
4.9.7.9 Option82 Port Setting .....	250
4.9.7.10 Option82 Circuit-ID Setting.....	252
4.9.8 Dynamic ARP Inspection .....	253
4.9.8.1 Global Setting.....	253
4.9.8.2 VLAN Setting.....	254
4.9.8.3 Port Setting.....	255
4.9.8.4 Statistics .....	257
4.9.8.5 Rate Limit .....	258
4.9.9 IP Source Guard.....	259
4.9.9.1 Port Settings.....	260
4.9.9.2 Binding Table.....	262
4.9.10 Port Security.....	263
4.9.11 DoS.....	265
4.9.11.1 Global DoS Setting .....	265
4.9.11.2 DoS Port Setting.....	268
4.9.12 Storm Control.....	269
4.9.12.1 Global Setting.....	269
4.9.12.2 Port Setting.....	270

<b>4.10 ACL</b> .....	<b>272</b>
4.10.1 MAC-based ACL .....	273
4.10.2 MAC-based ACE .....	274
4.10.3 IPv4-based ACL.....	277
4.10.4 IPv4-based ACE .....	278
4.10.5 IPv6-based ACL.....	283
4.10.6 IPv6-based ACE .....	284
4.10.7 ACL Binding.....	289
<b>4.11 MAC Address Table</b> .....	<b>290</b>
4.11.1 Static MAC Setting .....	291
4.11.2 MAC Filtering .....	292
4.11.3 Dynamic Address Setting.....	293
4.11.4 Dynamic Learned.....	294
<b>4.12 LLDP</b> .....	<b>296</b>
4.12.1 Link Layer Discovery Protocol .....	296
4.12.2 LLDP Global Setting .....	297
4.12.3 LLDP Port Setting.....	299
4.12.4 LLDP Local Device .....	302
4.12.5 LLDP Remove Device .....	304
4.12.6 MED Network Policy.....	305
4.12.7 MED Port Setting.....	309
4.12.8 LLDP Overloading .....	312
4.12.9 LLDP Statistics.....	313
<b>4.13 Diagnostics</b> .....	<b>315</b>
4.13.1 Cable Diagnostics.....	315
4.13.2 Ping .....	317
4.13.3 Ping Test.....	317
4.13.4 IPv6 Ping Test.....	318
4.13.5 Trace Router .....	319
<b>4.14 RMON</b> .....	<b>320</b>
4.14.1 RMON Statistics .....	320
4.14.2 RMON Event .....	322
4.14.3 RMON Event Log .....	323
4.14.4 RMON Alarm .....	324
4.14.5 RMON History .....	327
4.14.6 RMON History Log .....	328
<b>4.15 Power over Ethernet</b> .....	<b>329</b>
4.15.1 Power over Ethernet Powered Device.....	329
4.15.2 System Configuration .....	331
4.15.3 Power over Ethernet Configuration.....	332

4.15.4 PoE Schedule .....	335
4.15.5 PoE Alive Check Configuration .....	338
<b>4.16 Maintenance .....</b>	<b>340</b>
4.16.1 Factory Default .....	340
4.16.2 Reboot Switch .....	340
4.16.3 Backup Manager .....	341
4.16.4 Upgrade Manager .....	342
4.16.5 Dual Image .....	343
<b>5. SWITCH OPERATION .....</b>	<b>344</b>
5.1 Address Table.....	344
5.2 Learning.....	344
5.3 Forwarding & Filtering.....	344
5.4 Store-and-Forward.....	344
5.5 Auto-Negotiation.....	345
<b>6. TROUBLESHOOTING .....</b>	<b>346</b>
<b>APPENDIX A Switch's RJ45 Pin Assignments .....</b>	<b>348</b>
A.1 1000Mbps, 1000BASE-T.....	348
A.2 10/100Mbps, 10/100BASE-TX .....	348

# 1. INTRODUCTION

Thank you for purchasing PLANET IGS-4215 Industrial Managed Switch series, which comes with multiple Gigabit Ethernet copper and SFP fiber optic connectivity and robust layer 2 and layer 4 features. The description of this model is shown below:

<b>IGS-4215-4P4T</b>	Industrial 4-Port 10/100/1000T 802.3at PoE + 4-Port 10/100/100T Industrial Managed Switch (-40~75 degrees C)
<b>IGS-4215-4P4T2S</b>	Industrial 4-Port 10/100/1000T 802.3at PoE + 4-Port 10/100/100T + 2-Port 100/1000X SFP Industrial Managed Switch (-40~75 degrees C)

“Industrial Managed Switch” is used as an alternative name in this user’s manual.

## 1.1 Packet Contents

Open the box of the Industrial Managed Switch and carefully unpack it. The box should contain the following items:

Item	Model Name	
	IGS-4215-4P4T	IGS-4215-4P4T2S
The Industrial Managed Switch	■	■
Quick Installation Guide	■	■
RS-232 to RJ45 Console Cable	■	■
DIN-rail Kit	■	■
Wall Mounting Kit	■	■
SFP Dust Caps	---	2
SFP Dust Caps	9	9

If any item is found missing or damaged, please contact your local reseller for replacement.

## 1.2 Product Description

### Ideal, Cost-effective, Manageable PoE Solution for Hardened Environment

Designed to be installed in heavy industrial demanding environments, the IGS-4215 series are the new generation of PLANET Industrial-grade, DIN-rail type L2/L4 Managed Gigabit PoE+ Switch featuring **PLANET intelligent PoE** functions to improve the availability of critical business applications. It provides **IPv6/IPv4 dual stack management** and built-in **L2/L4 Gigabit switching engine** along with **4 10/100/1000BASE-T** ports featuring **30-watt 802.3at PoE+**, **4 additional Gigabit copper ports** and another **2 extra 100/1000BASE-X SFP fiber slots (IGS-4215-4P4T2S)** for data and video uplink. The IGS-4215 series are able to operate reliably, stably and quietly in any environment without affecting its performance. It comes with a total power budget of up to **144 watts** for different kinds of PoE applications and operating temperature ranging from **-40 to 75 degrees C** in a rugged IP30 metal housing.

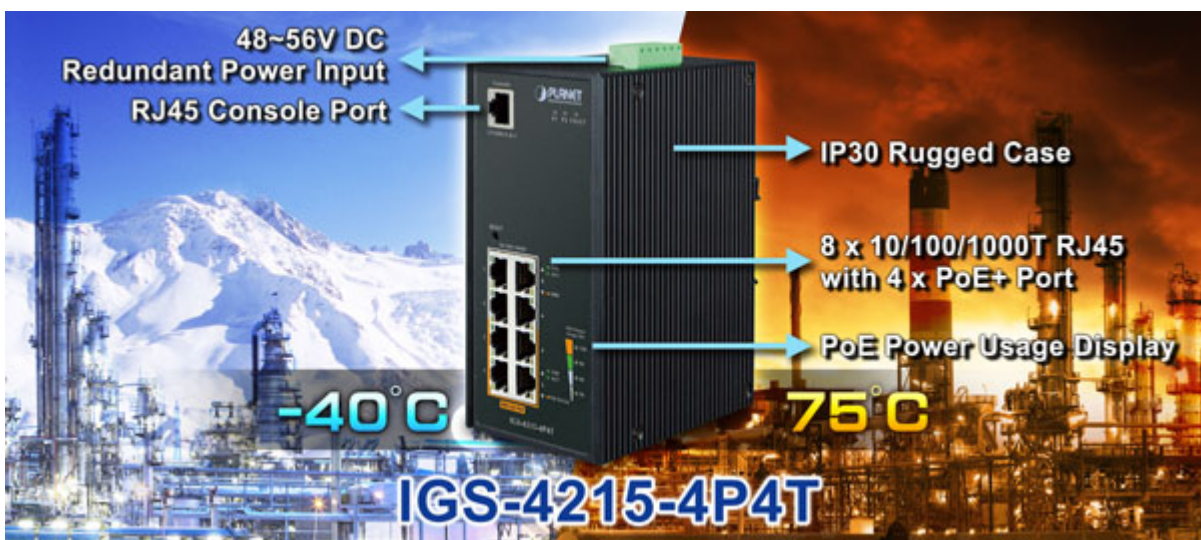
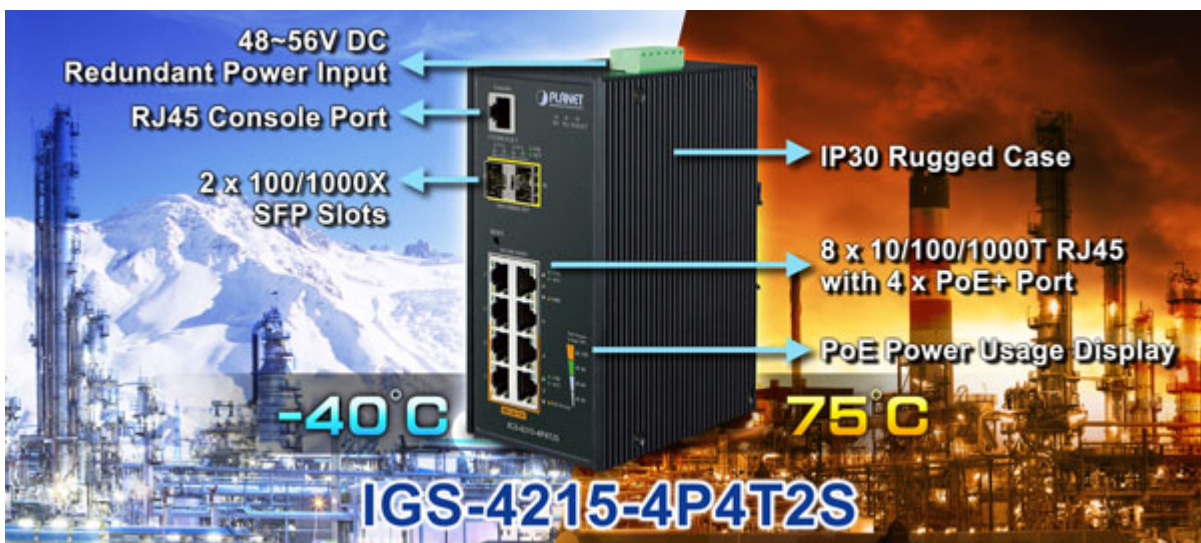

### Built-in Unique PoE Functions for Powered Devices Management

As it is the managed PoE switch for surveillance, wireless and VoIP networks, the IGS-4215 series feature the following special PoE management functions:



- PD alive check
- Scheduled power recycling
- PoE schedule
- PoE usage monitoring

### Intelligent Powered Device Alive Check

The IGS-4215 series can be configured to monitor connected PD (Powered Device) status in real time via ping action. Once the PD stops working and responding, the IGS-4215 series will resume the PoE port power and bring the PD back to work. It will greatly enhance the network reliability through the PoE port resetting the PD's power source and reducing administrator management burden.

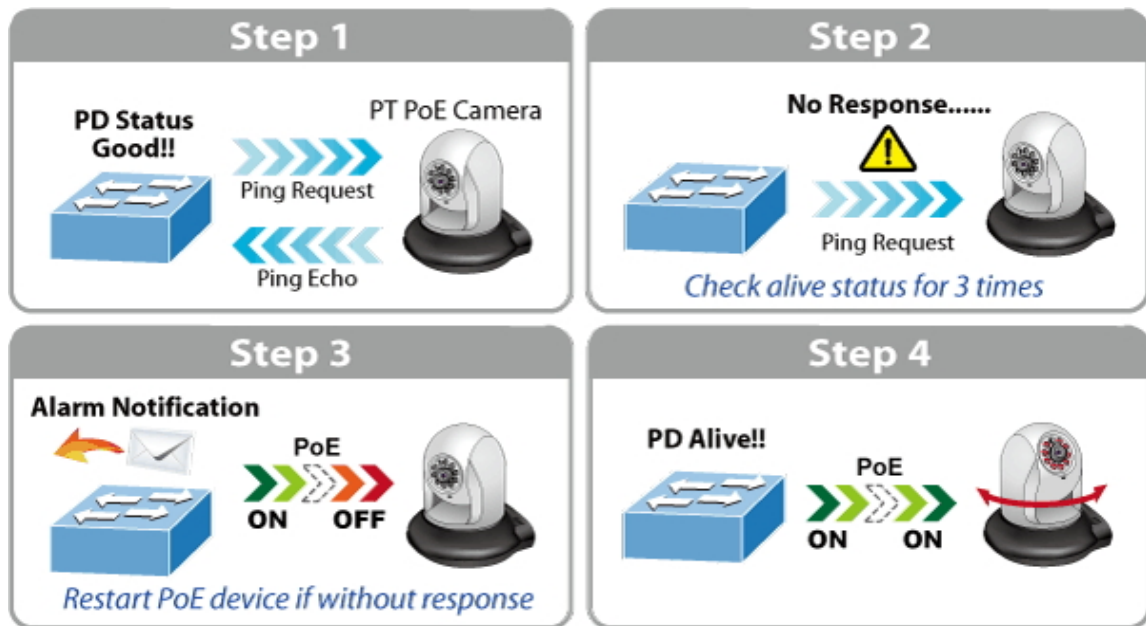

### Scheduled Power Recycling

The IGS-4215 series allows each of the connected PoE IP cameras or PoE wireless access points to reboot at a specific time each week. Therefore, it will reduce the chance of IP camera or AP crash resulting from buffer overflow.

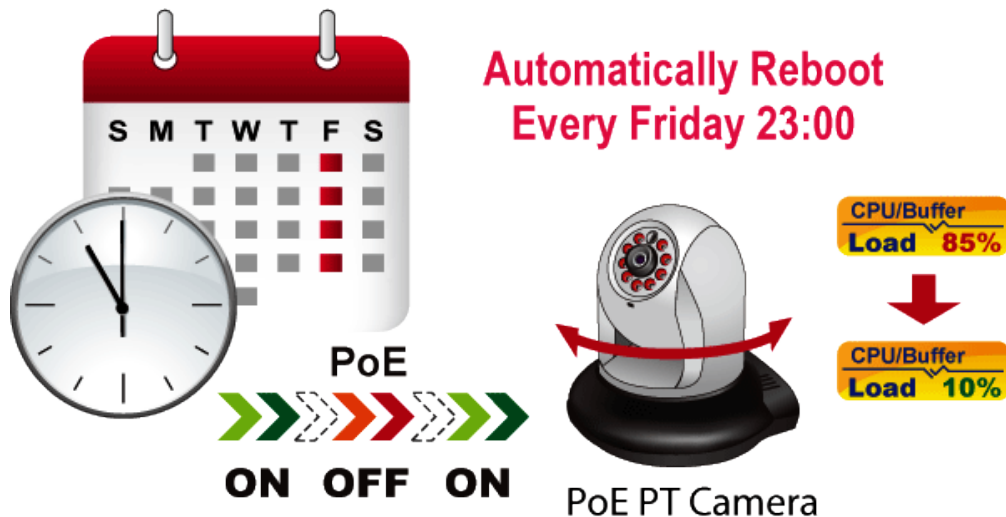

### PoE Schedule for Energy Saving

Under the trend of energy saving worldwide and contributing to environmental protection, the IGS-4215 series can effectively control the power supply besides its capability of giving high watts power. The “**PoE schedule**” function helps you to enable or disable PoE power feeding for each PoE port during specified time intervals and it is a powerful function to help SMBs or enterprises save power and budget. It also increases security by powering off PDs that should not be in use during non-business hours.

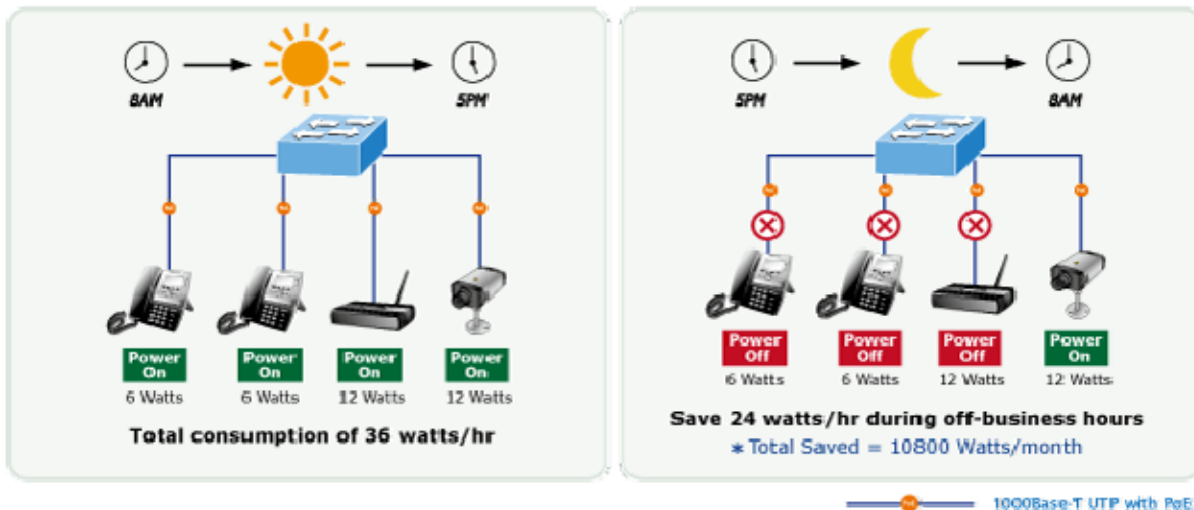

### PoE Usage Monitoring and Intelligent LED Indicator for Real-time PoE Usage

Via the power usage chart in the web management interface, the IGS-4215 series enables the administrator to monitor the status of the power usage of the connected PDs in real time. Thus, it greatly enhances the management efficiency of the facilities. Moreover, the IGS-4215 series helps users to monitor the current status of PoE power usage easily and efficiently via its advanced LED indication. Called “**PoE Power Usage**”, the front panel of the IGS-4215 series has four LED indicators of different power usages.



### Environmentally Hardened Design

With the IP30 aluminum industrial case, the IGS-4215 series provides a high level of immunity against electromagnetic interference and heavy electrical surges which are usually found on plant floors or in curb-side traffic control cabinets without air conditioner. Being able to operate under the temperature range from -40 to 75 degrees C, the IGS-4215 series can be placed in almost any difficult environment.

### IPv6/IPv4 Dual Stack Management

Supporting both IPv6 and IPv4 protocols, the IGS-4215 series helps the system integrators to step in the IPv6 era with the lowest investment as its network facilities need not be replaced or overhauled if the IPv6 network is set up.

### Robust Layer 2 Features

The IGS-4215 series can be programmed for advanced switch management functions such as dynamic port link aggregation, 802.1Q VLAN, **Q-in-Q VLAN**, **Multiple Spanning Tree Protocol (MSTP)**, Loop and **BPDU Guard**, **IGMP Snooping**, and **MLD Snooping**. Via the link aggregation, the IGS-4215 series allows the operation of a high-speed trunk to combine with multiple ports such as a 16Gbps fat pipe, and supports fail-over as well. Also, the **Link Layer Discovery Protocol (LLDP)** is the Layer 2 protocol included to help discover basic information about neighboring devices on the local broadcast domain.

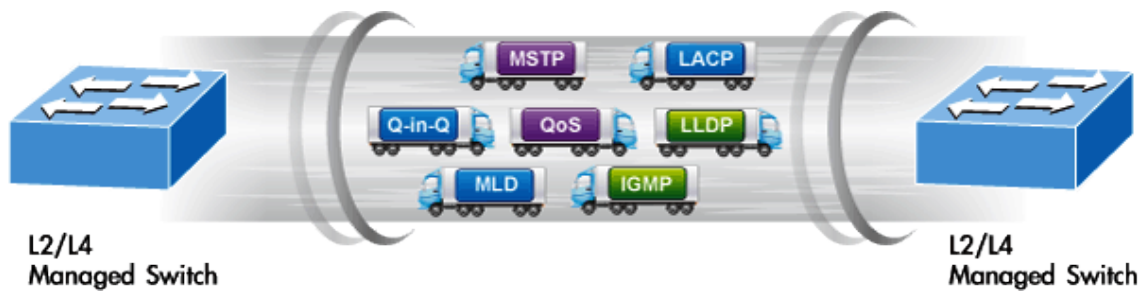

### Efficient Traffic Control

The IGS-4215 series are loaded with robust QoS features and powerful traffic management to enhance services to business-class data, voice, and video solutions. The functionality includes broadcast/multicast/unicast **storm control**, per port **bandwidth control**, 802.1p/CoS/IP DSCP QoS priority and remarking. It guarantees the best performance in VoIP and video stream transmission, and empowers the enterprises to take full advantage of the limited network resources.

### Friendly and Secure Management

For efficient management, the IGS-4215 series are equipped with **web**, **Telnet** and **SNMP** management interfaces. With the built-in web-based management interface, the IGS-4215 series offer an easy-to-use, platform-independent management and configuration facility. By supporting the standard SNMP, the switch can be managed via any standard management software. For text-based management, the switch can be accessed via Telnet. Moreover, the IGS-4215 series offer secure remote management by supporting **SSH**, **SSL** and **SNMP v3** connections which encrypt the packet content at each session.



## Advanced Network Security

PLANET IGS-4215 series offer a comprehensive **IPv4/IPv6** Layer 2 to Layer 4 **Access Control List (ACL)** for enforcing security to the edge. Its protection mechanism also comprises **802.1X port-based** user and device authentication, which can be deployed with RADIUS to ensure the port level security and block illegal users. With the **protected port** function, communication between edge ports can be prevented to guarantee user privacy. Furthermore, the IGS-4215 series also provide **DHCP snooping**, **IP source guard** and **dynamic ARP inspection** functions to prevent IP snooping from attack and discarded ARP packets with invalid MAC address. The network administrators can now construct highly-secure corporate networks with considerably less time and effort than before.

## Flexibility and Long-distance Extension Solution

The two mini-GBIC slots built in the IGS-4215-4P4T2S support SFP auto-detection and dual speed as it features **100BASE-FX** and **1000BASE-SX/LX SFP** (Small Form-factor Pluggable) fiber transceivers to uplink to backbone switch and monitoring center in long distance. The distance can be extended from 550 meters to 2 kilometers (multi-mode fiber) and up to 10/20/30/40/50/60/70/120 kilometers (single-mode fiber or WDM fiber). They are well suited for applications within the enterprise data centers and distributions.

## Intelligent SFP Diagnosis Mechanism

The IGS-4215-4P4T2S supports SFP-DDM (**Digital Diagnostic Monitor**) function that greatly helps network administrator to easily monitor real-time parameters of the SFP, such as optical output power, optical input power, temperature, laser bias current, and transceiver supply voltage



## **1.3 How to Use This Manual**

**This User Manual is structured as follows:**

### **Section 2, INSTALLATION**

The section explains the functions of the Switch and how to physically install the Industrial Managed Switch.

### **Section 3, SWITCH MANAGEMENT**

The section contains the information about the software function of the Industrial Managed Switch.

### **Section 4, WEB CONFIGURATION**

The section explains how to manage the Industrial Managed Switch by Web interface.

### **Section 5, SWITCH OPERATION**

The chapter explains how to do the switch operation of the Industrial Managed Switch.

### **Section 6, TROUBLESHOOTING**

The chapter explains how to troubleshoot the Industrial Managed Switch.

### **Appendix A**

The section contains cable information of the Industrial Managed Switch.

## 1.4 Product Features

### ▶ Physical Port

- 8-port 10/100/1000BASE-T Gigabit RJ45 copper with 4-pPort IEEE 802.3at / af PoE Injector (Port-1 to Port-4)
- 2 100/1000BASE-X mini-GBIC/SFP slots, SFP type auto detection (For IGS-4215-4P4T2S)
- RJ45 console interface for switch basic management and setup

### ▶ Power over Ethernet

- Complies with IEEE 802.3at Power over Ethernet Plus, end-span PSE
- Backward compatible with IEEE 802.3af Power over Ethernet
- Up to 4 ports of IEEE 802.3af/802.3at devices powered
- Supports PoE power up to 36 watts for each PoE port
- Auto detects powered device (PD)
- Circuit protection prevents power interference between ports
- Remote power feeding up to 100 meters
- PoE management
  - Total PoE power budget control
  - Per port PoE function enable/disable
  - PoE port power feeding priority
  - Per PoE port power limitation
  - PD classification detection
  - PD alive-check
  - PoE schedule

### ▶ Industrial Case & Installation

- IP30 aluminum metal case protection
- DIN-rail and wall-mount design
- Supports -40 to 75 degrees C operating temperature
- Supports ESD 6KV DC Ethernet protection
- Redundant power design
  - 48V~56V DC wide power input

### ▶ Switching

- Hardware based 10/100Mbps (half/full duplex), and 1000Mbps (full duplex) mode, flow control and auto-negotiation and auto MDI/MDI-X
- Features Store-and-Forward mode with wire-speed filtering and forwarding rates
- IEEE 802.3x flow control for full duplex operation and back pressure for half duplex operation
- 8K MAC address table size
- 10K jumbo frame
- Automatic address learning and address aging
- Supports CSMA/CD protocol

### ▶ Layer 2 Features

- Supports VLAN



- IEEE 802.1Q tagged VLAN
- Provider bridging (VLAN Q-in-Q, IEEE 802.1ad) support
- Protocol VLAN
- Voice VLAN
- Private VLAN (Protected port)
- Management VLAN
- GVRP

■ Supports **Spanning Tree Protocol**

- STP (Spanning Tree Protocol)
- RSTP (Rapid Spanning Tree Protocol)
- MSTP (Multiple Spanning Tree Protocol)
- STP BPDU Guard, BPDU Filtering and BPDU Forwarding

■ Supports **Link Aggregation**

- IEEE 802.3ad Link Aggregation Control Protocol (LACP)
- Cisco ether-channel (static trunk)
- Maximum 4 trunk groups, up to 4 ports per trunk group

■ Provides port mirror (many-to-1)

■ Loop protection to avoid broadcast loops

▶ **Quality of Service**

- Ingress/Egress Rate Limit per port bandwidth control
- Traffic classification
  - IEEE 802.1p CoS
  - TOS/DSCP/IP precedence of IPv4/IPv6 packets
- Strict priority and Weighted Round Robin (WRR) CoS policies

▶ **Multicast**

- Supports IPv4 IGMP snooping v2, and v3
- Supports IPv6 MLD snooping v1, v2
- IGMP querier mode support
- IGMP snooping port filtering
- MLD snooping port filtering

▶ **Security**

- Storm Control support
  - Broadcast/unknown unicast/unknown multicast
- Authentication
  - IEEE 802.1X port-based network access authentication
  - Built-in RADIUS client to co-operate with the RADIUS servers
  - DHCP Option 82
  - RADIUS/TACACS+ authentication
- Access Control List
  - IPv4/IPv6 IP-based ACL
  - IPv4/IPv6 IP-based ACE
  - MAC-based ACL
  - MAC-based ACE
- MAC Security
  - Static MAC



- MAC filtering

- Port security for source MAC address entries filtering
- DHCP snooping to filter distrusted DHCP messages
- Dynamic ARP inspection discards ARP packets with invalid MAC address to IP address binding
- IP source guard prevents IP spoofing attacks
- DoS attack prevention
- SSH / SSL

▶ **Management**

- IPv4 and IPv6 dual stack management
- Switch Management Interface
  - IPv4/IPv6 Web switch management
  - Console and Telnet Command Line Interface
  - SNMP v1, v2c, and v3
  - SSH and SSL secure access
- User privilege levels control
- Built-in Trivial File Transfer Protocol (TFTP) client
- Static and DHCP for IP address assignment
- System Maintenance
  - Firmware upload/download via HTTP/TFTP
  - Configuration upload/download through HTTP/TFTP
  - Hardware reset button for system reboot or reset to factory default
  - Dual images
- SNTP Network Time Protocol
- Cable diagnostics
- Link Layer Discovery Protocol (LLDP) Protocol and LLDP-MED
- SNMP trap for interface Link Up and Link Down notification
- Event message logging to remote syslog server
- Four RMON groups (history, statistics, alarms and events)
- PLANET Smart Discovery Utility

## 1.5 Product Specifications

### IGS-4215-4P4T / IGS-4215-4P4T2S

Product	IGS-4215-4P4T	IGS-4215-4P4T2S
<b>Hardware Specifications</b>		
<b>Copper Ports</b>	8 10/100/1000BASE-T RJ45 auto-MDI/MDI-X ports	
<b>SFP/mini-GBIC Slots</b>	NA	2 1000BASE-SX/LX/BX SFP interfaces (Port-9 and Port-10) Compatible with 100BASE-FX SFP
<b>PoE Injector Port</b>	4 port with 802.3af/802.3at PoE injector function (Port-1 to Port-4)	
<b>Console</b>	1 x RS232-to-RJ45 serial port (115200,8, N, 1)	
<b>Switch Architecture</b>	Store-and-Forward	
<b>Switch Fabric</b>	16Gbps/non-blocking	20Gbps/non-blocking
<b>Switch Throughput@64 bytes</b>	11.9Mpps @64 bytes	14.8Mpps @64 bytes
<b>MAC Address Table</b>	8K entries	
<b>Shared Data Buffer</b>	4.1 megabits	
<b>Flow Control</b>	IEEE 802.3x pause frame for full-duplex Back pressure for half-duplex	
<b>Jumbo Frame</b>	10 Kbytes	
<b>Reset Button</b>	< 5 sec: System reboot > 5 sec: Factory default	
<b>LED</b>	3 x LED for System and Power: <ul style="list-style-type: none"> <li>■ Green: DC Power 1</li> <li>■ Green: DC Power 2</li> <li>■ Green: Power Fault</li> </ul> 2 x LED for PoE Copper Port (Port-1~Port-4): <ul style="list-style-type: none"> <li>■ Green: LNK/ACT</li> <li>■ Orange: PoE -in-use</li> </ul> 2 x LED for 10/100/1000T Copper Port (Port-5~Port-8): <ul style="list-style-type: none"> <li>■ Green: LNK/ACT</li> <li>■ Orange: 1000Mbps</li> </ul> 2 x LED for per mini-GBIC interface (Port-9 and Port-10)(IGS-4215-4P4T2S) <ul style="list-style-type: none"> <li>■ Green: LNK/ACT</li> <li>■ Orange: 1000Mbps</li> </ul> 4 x LED for PoE Power Usage (W) <ul style="list-style-type: none"> <li>■ Orange: 30, 60, 90 and 120W</li> </ul>	
<b>Connector</b>	Removable 6-pin terminal block Pin 1/2 for Power 1; Pin 3/4 for fault alarm; Pin 5/6 for Power 2	
<b>Alarm</b>	One relay output for power failure. Alarm relay current carry ability: 1A @ 24V AC	

<b>Power Requirements</b>	48~56V DC, 3.5A (max.)	
<b>Power Consumption/ Dissipation</b>	5.04 watts, 17.1BTU (Standby without PoE function)	5.04 watts, 17.1BTU (Standby without PoE function)
	7.28 watts, 23 BTU (Full loading without PoE function)	8.96 watts, 30.5 BTU (Full loading without PoE function)
	151.28 watts, 516.1 BTU (Full loading with PoE function)	152.96 watts, 521.8 BTU (Full loading with PoE function)
<b>Dimensions (W x D x H)</b>	161 x 107 x 72 mm	
<b>Weight</b>	1001g	1004g
<b>ESD Protection</b>	6KV DC	
<b>Enclosure</b>	IP30 aluminum case	
<b>Installation</b>	DIN-rail kit and wall-mount ear	
<b>Power over Ethernet</b>		
<b>PoE Standard</b>	IEEE 802.3af/802.3at Power over Ethernet PSE	
<b>PoE Power Supply Type</b>	End-span	
<b>PoE Power Output</b>	IEEE 802.3af Standard - Per port 48V~56V DC (depending on the power supply), max. 15.4 watts  IEEE 802.3at Standard - Per port 50V~56V DC (depending on the power supply), max. 36 watts	
<b>Power Pin Assignment</b>	1/2(+), 3/6(-)	
<b>PoE Power Budget</b>	144 watts (depending on power input)	
<b>Max. Number of Class 2 PDs</b>	4	
<b>Max. Number of Class 3 PDs</b>	4	
<b>Max. Number of Class 4 PDs</b>	4	
<b>Layer 2 Functions</b>		
<b>Port Mirroring</b>	TX/RX/Both Many-to-1 monitor	
<b>VLAN</b>	802.1Q tagged-based VLAN Up to 256 VLAN groups, out of 4094 VLAN IDs 802.1ad Q-in-Q tunneling (VLAN stacking) Voice VLAN Protocol VLAN Private VLAN (Protected port) GVRP Management VLAN	
<b>Link Aggregation</b>	IEEE 802.3ad LACP and static trunk Supports 4 groups with 4 ports per trunk	
<b>Spanning Tree Protocol</b>	IEEE 802.1D Spanning Tree Protocol (STP) IEEE 802.1w Rapid Spanning Tree Protocol (RSTP) IEEE 802.1s Multiple Spanning Tree Protocol (MSTP) STP BPDU Guard, BPDU Filtering and BPDU Forwarding	

<b>IGMP Snooping</b>	<p>IPv4 IGMP snooping v2, v3</p> <p>IGMP querier</p> <p>Up to 256 multicast groups</p>
<b>MLD Snooping</b>	<p>IPv6 MLD snooping v2, v3, up to 256 multicast groups</p>
<b>Access Control List</b>	<p>IPv4/IPv6 IP-based ACL/MAC-based ACL</p> <p>IPv4/IPv6 IP-based ACE/MAC-based ACE</p>
<b>QoS</b>	<p>8 mapping IDs to 8 level priority queues</p> <ul style="list-style-type: none"> <li>- Port number</li> <li>- 802.1p priority</li> <li>- DSCP/IP precedence of IPv4/IPv6 packets</li> </ul> <p>Traffic classification based, strict priority and WRR</p> <p>Ingress/Egress Rate Limit per port bandwidth control</p>
<b>Security</b>	<p>IEEE 802.1X port-based authentication</p> <p>Built-in RADIUS client to cooperate with RADIUS server</p> <p>RADIUS/TACACS+ authentication</p> <p>IP-MAC port binding</p> <p>MAC filtering</p> <p>Static MAC address</p> <p>DHCP snooping and DHCP Option82</p> <p>STP BPDU guard, BPDU filtering and BPDU forwarding</p> <p>DoS attack prevention</p> <p>ARP inspection</p> <p>IP source guard</p> <p>Storm control support</p> <ul style="list-style-type: none"> <li>- Broadcast/Unknown unicast/Unknown multicast</li> </ul>
<b>Management Functions</b>	
<b>Basic Management Interfaces</b>	<p>Web browser; Console; Telnet; SNMP v1, v2c, v3</p> <p>Firmware upgrade by HTTP/TFTP protocol through Ethernet network</p> <p>Configuration upload/download through HTTP/TFTP</p> <p>Remote/local syslog</p> <p>System log</p> <p>LLDP protocol</p> <p>SNTP</p> <p>PLANET Smart Discovery Utility</p>
<b>Secure Management Interfaces</b>	<p>SSH, SSL, SNMP v3</p>
<b>SNMP MIBs</b>	<p>RFC 1213 MIB-II</p> <p>RFC 1215 Generic Traps</p> <p>RFC 1493 Bridge MIB</p> <p>RFC 2674 Bridge MIB Extensions</p> <p>RFC 2737 Entity MIB v2</p> <p>RFC 2819 RMON (1, 2, 3, 9)</p> <p>RFC 2863 Interface Group MIB</p> <p>RFC 3635 Ethernet-like MIB</p>
<b>Standards Conformance</b>	

<b>Regulatory Compliance</b>	FCC Part 15 Class A, CE
<b>Stability Testing</b>	IEC 60068-2-32 (free fall) IEC 60068-2-27 (shock) IEC 60068-2-6 (vibration)
<b>Standards Compliance</b>	IEEE 802.3 10BASE-T IEEE 802.3u 100BASE-TX/100BASE-FX IEEE 802.3z Gigabit SX/LX IEEE 802.3ab Gigabit 1000BASE-T IEEE 802.3x Flow Control and Back Pressure IEEE 802.3ad Port Trunk with LACP IEEE 802.1D Spanning Tree Protocol IEEE 802.1w Rapid Spanning Tree Protocol IEEE 802.1s Multiple Spanning Tree Protocol IEEE 802.1p Class of Service IEEE 802.1Q VLAN Tagging IEEE 802.1x Port Authentication Network Control IEEE 802.1ab LLDP RFC 768 UDP RFC 793 TFTP RFC 791 IP RFC 792 ICMP RFC 2068 HTTP RFC 1112 IGMP v1 RFC 2236 IGMP v2 RFC 3376 IGMP v3 RFC 2710 MLD v1 RFC 3810 MLD v2
<b>Environment</b>	
<b>Operating</b>	Temperature: -40 ~ 75 degrees C Relative Humidity: 5 ~ 95% (non-condensing)
<b>Storage</b>	Temperature: -40 ~ 85 degrees C Relative Humidity: 5 ~ 95% (non-condensing)

## 2. INSTALLATION

### 2.1 Hardware Description

This section describes the hardware features and installation of the Industrial Managed Switch on the desktop or rack mount. For easier management and control of the Industrial Managed Switch, familiarize yourself with its display indicators and ports. Front panel illustrations in this chapter display the unit LED indicators. Before connecting any network device to the Industrial Managed Switch, please read this chapter completely.

#### 2.1.1 Physical Dimensions

##### IGS-4215-4P4T

##### ■ IGS-4215-4P4T

- Dimensions (W x D x H) : 161 x 101 x 72mm

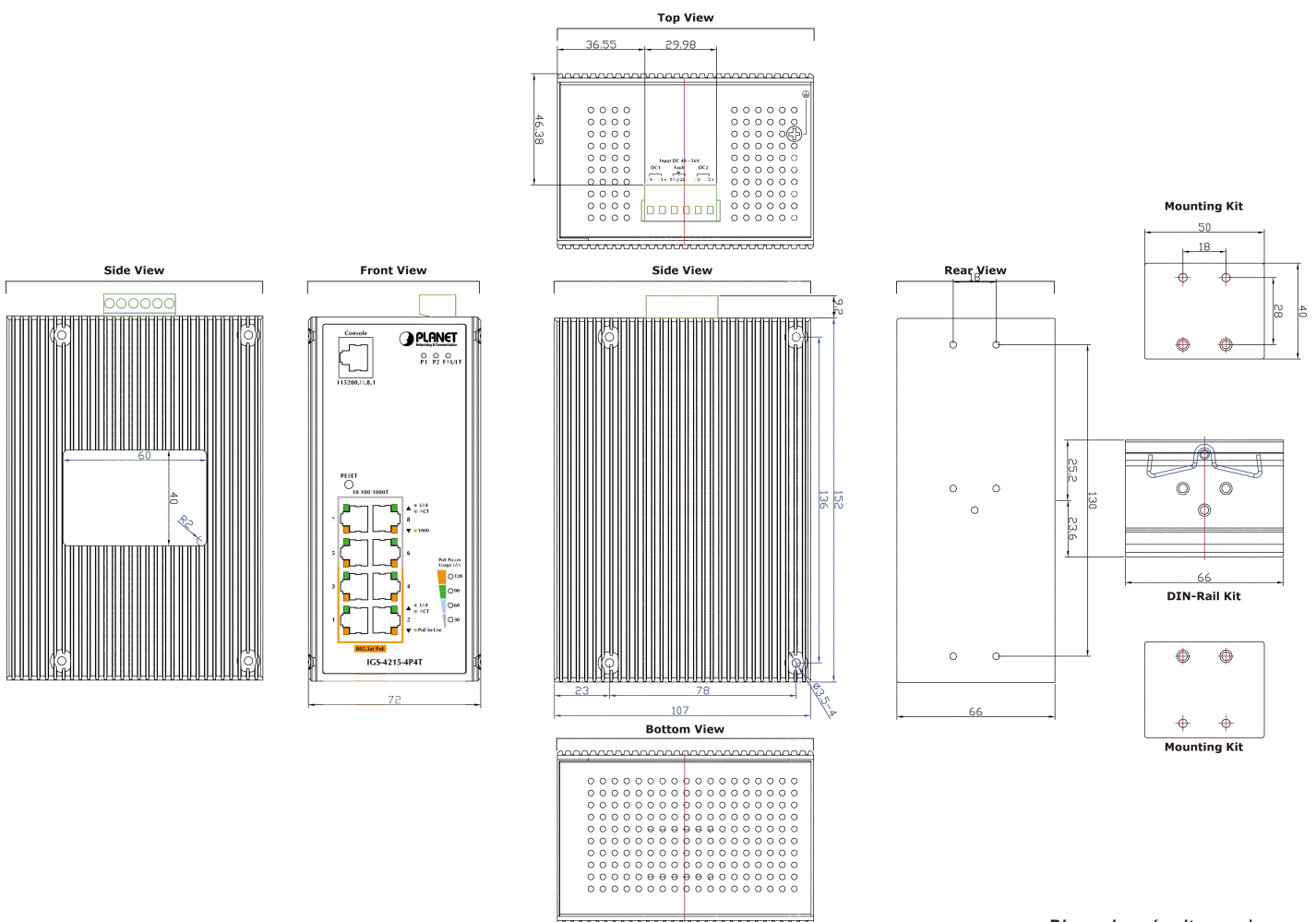

Dimensions (unit = mm)

**IGS-4215-4P4T2S**

■ IGS-4215-4P4T2S

- Dimensions (W x D x H) : 161 x 101 x 72mm

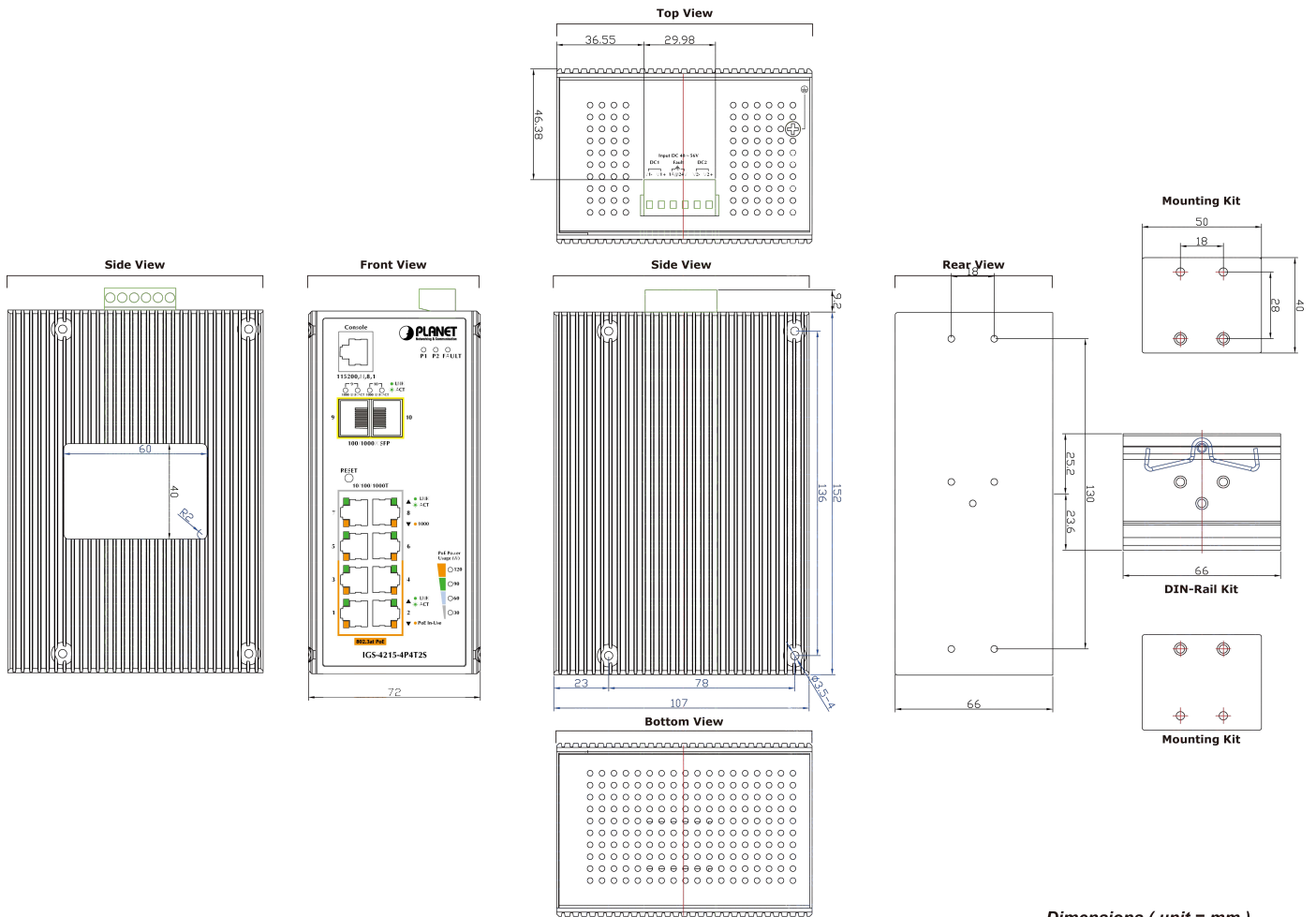

Dimensions ( unit = mm )

**2.1.2 Switch Front Panel**

The front panel provides a simple interface monitoring of the Industrial Managed Switch. Figure 2-1-2a shows the front panel of the Industrial Managed Switch.

**IGS-4215-4P4T and IGS-4215-4P4T2S Front Panel**



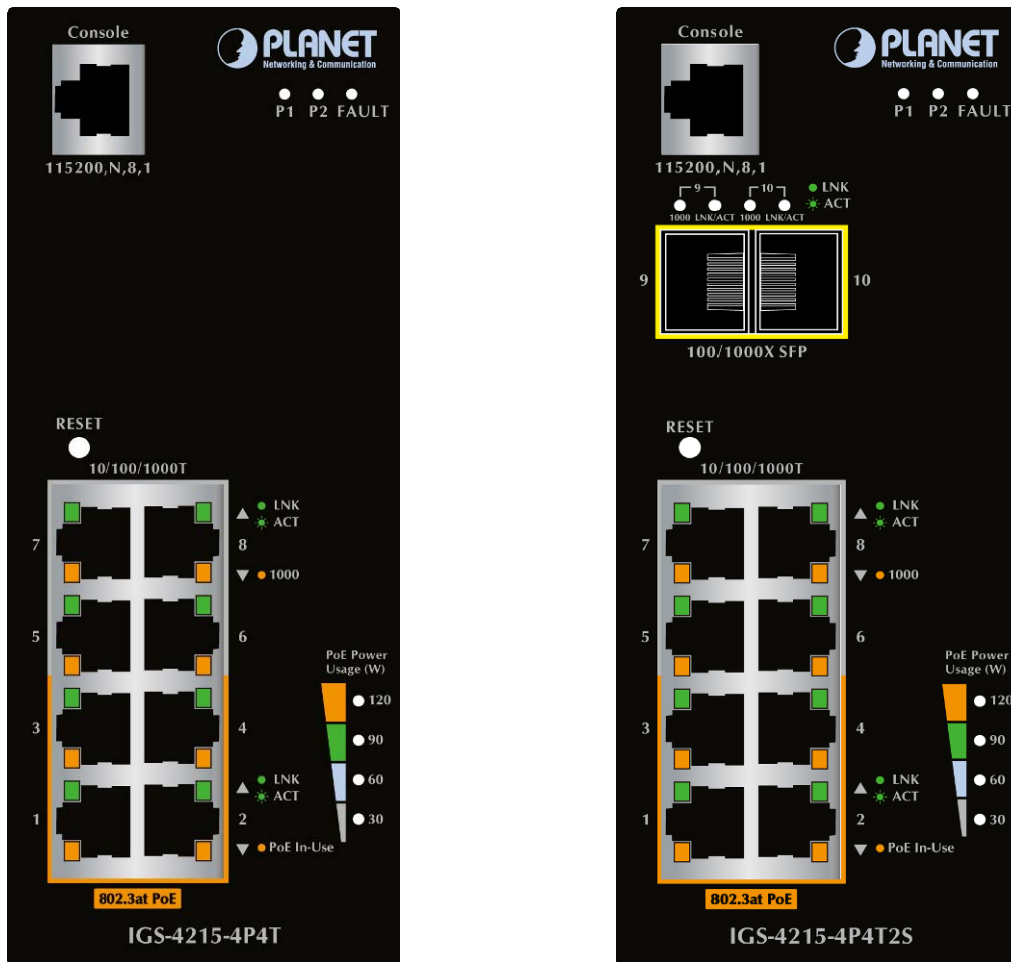

Figure 2-1-2a IGS-4215-4P4T and IGS-4215-4P4T2S Front Panel

■ **Gigabit TP Interface**

10/100/1000BASE-T copper, RJ45 twisted-pair: Up to 100 meters.

■ **100/1000BASE-X SFP Slots**

Each of the SFP (Small Form-factor Pluggable) slots supports dual-speed, 1000BASE-SX/LX or 100BASE-FX

- For 1000BASE-SX/LX SFP transceiver module: From 550 meters (multi-mode fiber) to 10/30/50/70/120 kilometers (single-mode fiber).
- For 100BASE-FX SFP transceiver module: From 2 kilometers (multi-mode fiber) to 20/40/60 kilometers (single-mode fiber).

■ **Console Port**

The console port is an RJ45 port connector. It is an interface for connecting a terminal directly. Through the console port, it provides rich diagnostic information including IP address setting, factory reset, port management, link status and system setting.

Users can use the attached **DB9 to RJ45 console cable** in the package and connect to the console port on the device. After the connection, users can run any terminal emulation program (**Hyper Terminal, ProComm Plus, Telix, Winterm** and so on) to enter the startup screen of the device.

## Reset Button

On the left of the front panel, the reset button is designed to reboot the Industrial Managed Switch without turning off and on the power. The following is the summary table of Reset button functions:

Reset Button Pressed and Released	Function
< 5 sec: System Reboot	Reboot the Industrial Managed Switch.
> 5 sec: Factory Default	Reset the Industrial Managed Switch to Factory Default configuration. The Industrial Managed Switch will then reboot and load the default settings shown below: <ul style="list-style-type: none"> <li>◦ Default username: <b>admin</b></li> <li>◦ Default password: <b>admin</b></li> <li>◦ Default IP address: <b>192.168.0.100</b></li> <li>◦ Subnet mask: <b>255.255.255.0</b></li> <li>◦ Default gateway: <b>192.168.0.254</b></li> </ul>

## 2.1.3 LED Indications

The front panel LEDs indicate instant status of port links, data activity and system power; it helps monitor and troubleshoot when needed. Figure 2-1-3a shows the LED indications of these Industrial Managed Switches.

### IGS-4215-4P4T and IGS-4215-4P4T2S LED Indication

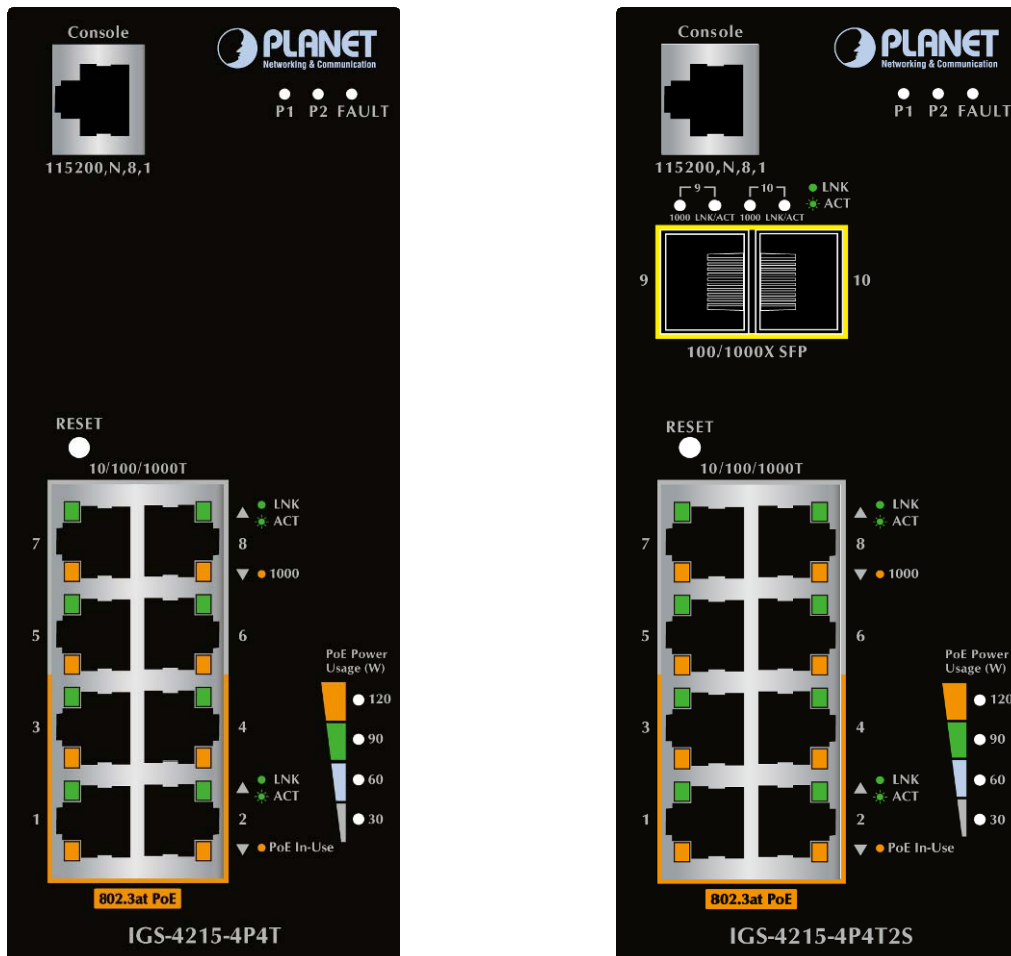

Figure 2-1-3a IGS-4215-4P4T and IGS-4215-4P4T2S LED Panel

■ System

LED	Color	Function
P1	Green	Lights to indicate Power 1 has power.
P2	Green	Lights to indicate Power 2 has power.
FAULT	Green	Lights to indicate either Power 1 or Power 2 has no power.

■ PoE 10/100/1000BASE-T interfaces(Port-1 to Port-4)

LED	Color	Function
LNK/ACT	Green	<b>Lights:</b> To indicate the link through that port is successfully established.
		<b>Blinks:</b> To indicate that the switch is actively sending or receiving data over that port.
PoE	Orange	<b>Lights:</b> To indicate the port is providing DC in-line power.
		<b>Off:</b> To indicate the connected device is not a PoE Powered Device (PD)

■ 10/100/1000BASE-T interfaces (Port-5 to Port-8)

LED	Color	Function
LNK/ACT	Green	<b>Lights:</b> To indicate the link through that port is successfully established.
		<b>Blinks:</b> To indicate that the switch is actively sending or receiving data over that port.
1000	Orange	<b>Lights:</b> To indicate that the port is operating at <b>1000Mbps</b> .
		<b>Off:</b> If LNK/ACT LED is lit, it indicates that the port is operating at <b>10/100Mbps</b> . If LNK/ACT LED is Off, it indicates that the port is link-down.

■ 100/1000BASE-X interfaces (Port-9 to Port-10) ( For IGS-4215-4P4T2S)

LED	Color	Function
LNK/ACT	Green	<b>Lights:</b> To indicate the link through that port is successfully established.
		<b>Blinks:</b> To indicate that the switch is actively sending or receiving data over that port.
1000	Orange	<b>Lights:</b> To indicate that the port is operating at <b>1000Mbps</b> .
		<b>Off:</b> If LNK/ACT LED is lit, it indicates that the port is operating at <b>100Mbps</b> . If LNK/ACT LED is Off, it indicates that the port is link-down.

■ PoE Power Usage (Unit: Watt)

LED	Color	Function
30	Orange	<b>Lights:</b> To indicate the system consumes over 30-watt PoE power budget
60	Orange	<b>Lights:</b> To indicate the system consumes over 60-watt PoE power budget
90	Orange	<b>Lights:</b> To indicate the system consumes over 90-watt PoE power budget
120	Orange	<b>Lights:</b> To indicate the system consumes over 120-watt PoE power budget

### 2.1.4 Switch Upper Panel

The upper panel of the Industrial Gigabit PoE+ Switch consists of one terminal block connector within two DC power inputs.

Figure 2-1-4a shows the upper panel of the Switch.

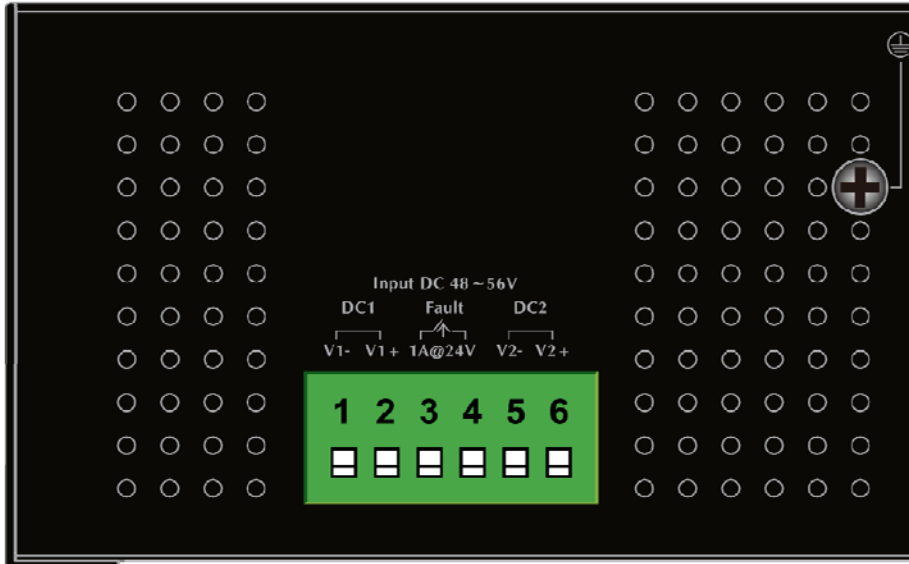
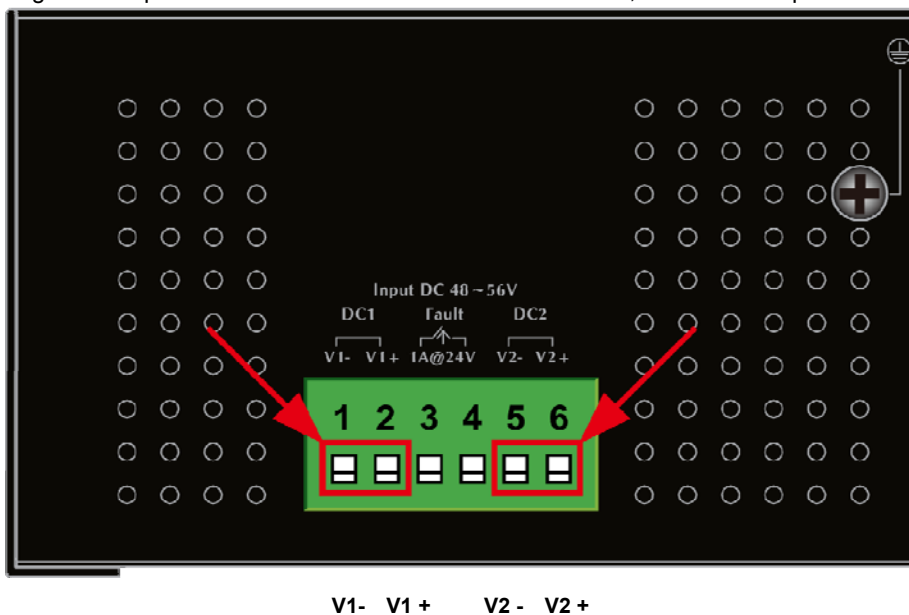

Figure 2-1-4a: Industrial Gigabit PoE Switch Upper Panel.

### 2.1.5 Wiring the Power Inputs

The 6-contact terminal block connector on the top panel of Industrial Gigabit PoE+ Switch is used for two DC redundant powers input. Please follow the steps below to insert the power wire.

1. Insert positive/negative DC power wires into contacts 1 and 2 for Power 1, or 5 and 6 for power.



- Tighten the wire-clamp screws for preventing the wires from loosening.

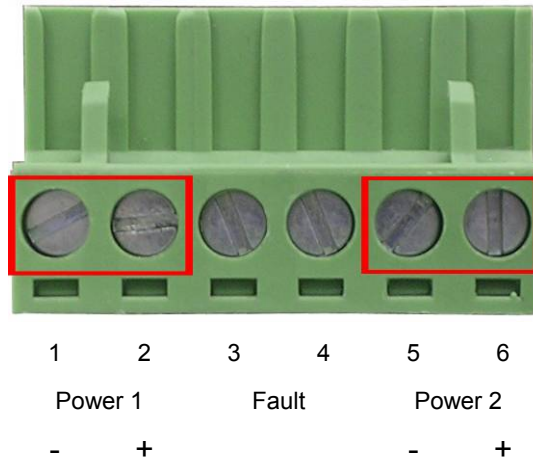

The wire gauge for the terminal block should be in the range between 12 and 24 AWG.

### 2.1.6 Wiring the Faulty Alarm Contact

The faulty alarm contacts are in the middle of the terminal block connector as the picture shows below. Inserting the wires, the Industrial Gigabit PoE+ Switch will detect the fault status of the power failure, or port link failure (available for managed model) and then forms an open circuit. The following illustration shows an application example for wiring the faulty alarm contacts.

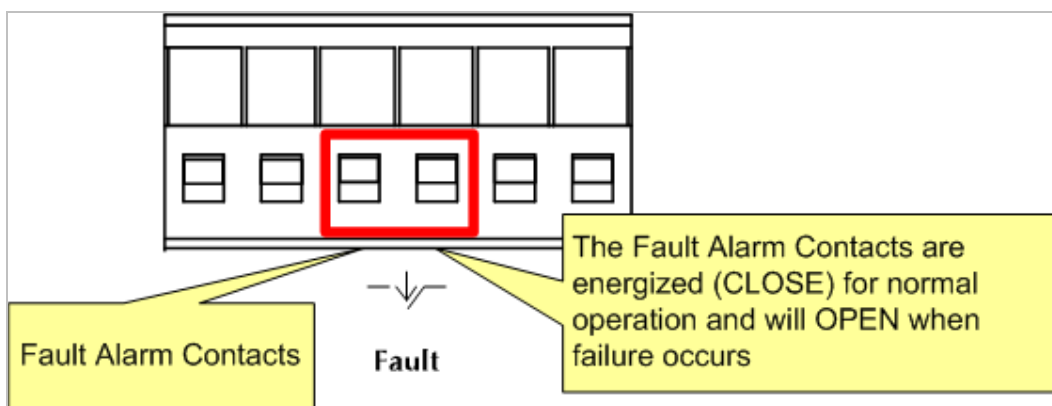

Insert the wires into the fault alarm contacts



- The wire gauge for the terminal block should be in the range of 12 ~ 24 AWG.
- Alarm relay circuit accepts up to 30V, max. 3A currents.

## 2.2 Installing the Industrial Managed Switch

This section describes how to install your **Industrial Managed Switch** and make connections to the **Industrial Managed Switch**. Please read the following topics and perform the procedures in the order being presented. To install your **Industrial Managed Switch** on a desktop or shelf, simply complete the following steps.

In this paragraph, we will describe how to install the **Industrial Managed Switch** and the installation points attended to it.

### 2.2.1 Installation Steps

1. **Unpack the Industrial Managed Switch**
2. **Check if the DIN-Rail is screwed on the Industrial Managed Switch or not.** If the DIN-Rail is not screwed on the **Industrial Managed Switch**, please refer to **DIN-rail Mounting** section for DIN-rail installation. If users want to wall-mount the **Industrial Managed Switch**, please refer to the **Wall Mount Plate Mounting** section for wall-mount plate installation.
3. **To hang the Industrial Managed Switch on the DIN-rail track or wall.**
4. **Power on the Industrial Managed Switch.** Please refer to the **Wiring the Power Inputs** section for knowing the information about how to wire the power. The power LED on the **Industrial Managed Switch** will light up. Please refer to the **LED Indicators** section for indication of LED lights.
5. **Prepare the twisted-pair, straight-through Category 5 cable for Ethernet connection.**
6. **Insert one side of RJ45 cable (category 5) into the Industrial Managed Switch Ethernet port** (RJ45 port) while the other side to the network device's Ethernet port (RJ45 port), e.g., Switch PC or Server. The UTP port (RJ45) LED on the **Industrial Managed Switch** will light up when the cable is connected with the network device. Please refer to the **LED Indicators** section for LED light indication.



---

Make sure that the connected network devices support MDI/MDI-X. If it does not support, use the crossover Category 5 cable.

---

7. **When all connections are set and all LED lights show normal, the installation is completed.**

## 2.2.2 DIN-rail Mounting

This section describes how to install the **Industrial Managed Switch**. There are two methods to install the **Industrial Managed Switch** -- DIN-rail mounting and wall-mount plate mounting. Please read the following topics and perform the procedures in the order being presented.



**Follow all the DIN-rail installation steps as shown in the example.**

**Step 1:** Screw the DIN-rail on the **Industrial Managed Switch**.



**Step 2:** Lightly slide the DIN-rail into the track.





**Step 3:** Check whether the DIN-rail is tightly on the track.

Please refer to the following procedures to remove the **Industrial Managed Switch** from the track.

**Step 4:** Lightly remove the DIN-rail from the track.



## 2.2.3 Wall Mount Plate Mounting

To install the **Industrial Managed Switch** on the wall, please follow the instructions below.



**Follow all the DIN-rail installation steps as shown in the example.**

**Step 1:** Remove the DIN-rail from the **Industrial Managed Switch**. Use the screwdriver to loosen the screws to remove the DIN-rail.

**Step 2:** Place the wall-mount plate on the rear panel of the **Industrial Managed Switch**.



**Step 3:** Use the screwdriver to screw the wall mount plate on the **Industrial Managed Switch**.

**Step 4:** Use the hook holes at the corners of the wall mount plate to hang the **Industrial Managed Switch** on the wall.

**Step 5:** To remove the wall mount plate, reverse the steps above.

## 2.2.4 Installing the SFP transceiver (For IGS-4215-4P4T2S)

The sections describe how to insert an SFP transceiver into an SFP slot. The SFP transceivers are hot-pluggable and hot-swappable. You can plug in and out the transceiver to/from any SFP port without having to power down the **Industrial Managed Switch** as [Figure 2-2-4a](#) appears.

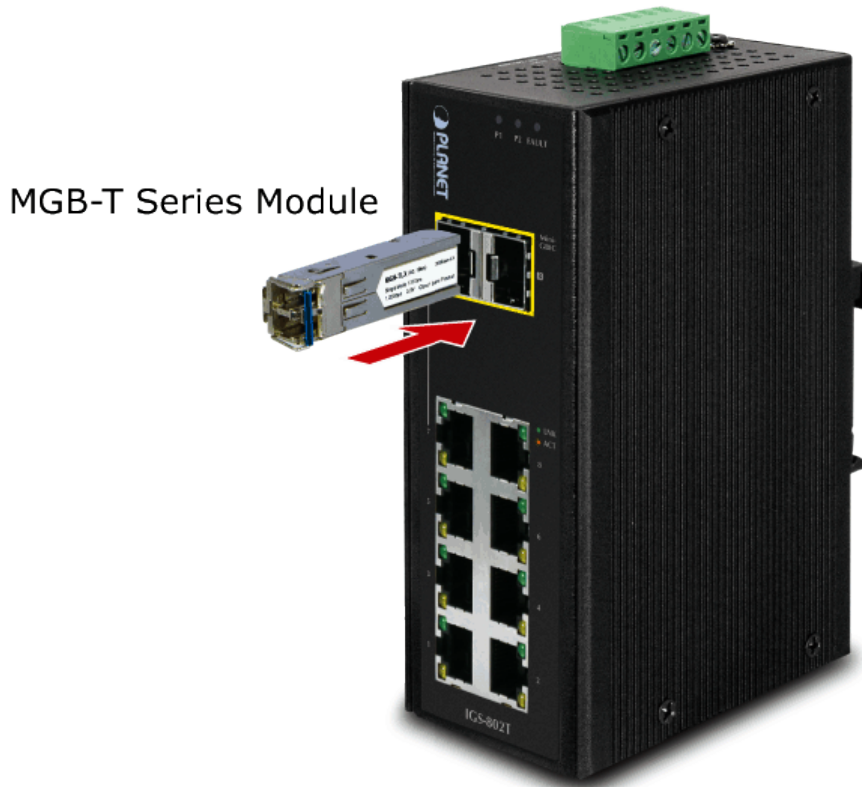

Figure 2-2-4a: Plug in the SFP Transceiver

### ■ Approved PLANET SFP Transceivers

PLANET **Industrial Managed Switch** supports 100/1000 dual mode with both single mode and multi-mode SFP transceivers. The following list of approved PLANET SFP transceivers is correct at the time of publication:

#### Fast Ethernet Transceiver (100BASE-X SFP)

Model	Speed (Mbps)	Connector Interface	Fiber Mode	Distance	Wavelength (nm)	Operating Temp.
MFB-FX	100	LC	Multi Mode	2km	1310nm	0 ~ 60 degrees C
MFB-F20	100	LC	Single Mode	20km	1310nm	0 ~ 60 degrees C
MFB-F40	100	LC	Single Mode	40km	1310nm	0 ~ 60 degrees C
MFB-F60	100	LC	Single Mode	60km	1310nm	0 ~ 60 degrees C
MFB-F120	100	LC	Single Mode	120km	1550nm	0 ~ 60 degrees C
MFB-TFX	100	LC	Multi Mode	2km	1310nm	-40 ~ 75 degrees C
MFB-TF20	100	LC	Single Mode	20km	1550nm	-40 ~ 75 degrees C

**Fast Ethernet Transceiver (100BASE-BX, Single Fiber Bi-directional SFP)**

Model	Speed (Mbps)	Connector Interface	Fiber Mode	Distance	Wavelength (TX)	Wavelength (RX)	Operating Temp.
MFB-FA20	100	WDM(LC)	Single Mode	20km	1310nm	1550nm	0 ~ 60 degrees C
MFB-FB20	100	WDM(LC)	Single Mode	20km	1550nm	1310nm	0 ~ 60 degrees C
MFB-TFA20	100	WDM(LC)	Single Mode	20km	1310nm	1550nm	-40 ~ 75 degrees C
MFB-TFB20	100	WDM(LC)	Single Mode	20km	1550nm	1310nm	-40 ~ 75 degrees C
MFB-TFA40	100	WDM(LC)	Single Mode	40km	1310nm	1550nm	-40 ~ 75 degrees C
MFB-TFB40	100	WDM(LC)	Single Mode	40km	1550nm	1310nm	-40 ~ 75 degrees C

**Gigabit Ethernet Transceiver (1000BASE-X SFP)**

Model	Speed (Mbps)	Connector Interface	Fiber Mode	Distance	Wavelength (nm)	Operating Temp.
MGB-GT	1000	Copper	--	100m	--	0 ~ 60 degrees C
MGB-SX	1000	LC	Multi Mode	550m	850nm	0 ~ 60 degrees C
MGB-SX2	1000	LC	Multi Mode	2km	1310nm	0 ~ 60 degrees C
MGB-LX	1000	LC	Single Mode	10km	1310nm	0 ~ 60 degrees C
MGB-L30	1000	LC	Single Mode	30km	1310nm	0 ~ 60 degrees C
MGB-L50	1000	LC	Single Mode	50km	1550nm	0 ~ 60 degrees C
MGB-L70	1000	LC	Single Mode	70km	1550nm	0 ~ 60 degrees C
MGB-L120	1000	LC	Single Mode	120km	1550nm	0 ~ 60 degrees C
MGB-TSX	1000	LC	Multi Mode	550m	850nm	-40 ~ 75 degrees C
MGB-TLX	1000	LC	Single Mode	10km	1310nm	-40 ~ 75 degrees C
MGB-TL30	1000	LC	Single Mode	30km	1310nm	-40 ~ 75 degrees C
MGB-TL70	1000	LC	Single Mode	70km	1550nm	-40 ~ 75 degrees C

**Gigabit Ethernet Transceiver (1000BASE-BX, Single Fiber Bi-directional SFP)**

Model	Speed (Mbps)	Connector Interface	Fiber Mode	Distance	Wavelength (TX)	Wavelength (RX)	Operating Temp.
MGB-LA10	1000	WDM(LC)	Single Mode	10km	1310nm	1550nm	0 ~ 60 degrees C
MGB-LB10	1000	WDM(LC)	Single Mode	10km	1550nm	1310nm	0 ~ 60 degrees C
MGB-LA20	1000	WDM(LC)	Single Mode	20km	1310nm	1550nm	0 ~ 60 degrees C
MGB-LB20	1000	WDM(LC)	Single Mode	20km	1550nm	1310nm	0 ~ 60 degrees C
MGB-LA40	1000	WDM(LC)	Single Mode	40km	1310nm	1550nm	0 ~ 60 degrees C
MGB-LB40	1000	WDM(LC)	Single Mode	40km	1550nm	1310nm	0 ~ 60 degrees C
MGB-LA60	1000	WDM(LC)	Single Mode	60km	1310nm	1550nm	0 ~ 60 degrees C
MGB-LB60	1000	WDM(LC)	Single Mode	60km	1550nm	1310nm	0 ~ 60 degrees C
MGB-TLA10	1000	WDM(LC)	Single Mode	10km	1310nm	1550nm	-40 ~ 75 degrees C
MGB-TLB10	1000	WDM(LC)	Single Mode	10km	1550nm	1310nm	-40 ~ 75 degrees C
MGB-TLA20	1000	WDM(LC)	Single Mode	20km	1310nm	1550nm	-40 ~ 75 degrees C
MGB-TLB20	1000	WDM(LC)	Single Mode	20km	1550nm	1310nm	-40 ~ 75 degrees C
MGB-TLA40	1000	WDM(LC)	Single Mode	40km	1310nm	1550nm	-40 ~ 75 degrees C

MGB-TLB40	1000	WDM(LC)	Single Mode	40km	1550nm	1310nm	-40 ~ 75 degrees C
MGB-TLA60	1000	WDM(LC)	Single Mode	60km	1310nm	1550nm	-40 ~ 75 degrees C
MGB-TLB60	1000	WDM(LC)	Single Mode	60km	1550nm	1310nm	-40 ~ 75 degrees C



It is recommended to use PLANET SFPs on the **Industrial Managed Switch**. If you insert an SFP transceiver that is not supported, the **Industrial Managed Switch** might not recognize it.



Please choose the SFP transceiver which can be operated in the temperature range of -40~75 degrees C.

### 1000BASE-SX/LX:

Before connecting the other switches, workstation or media converter,

1. Make sure both sides of the SFP transceiver are with the same media type, for example, 1000BASE-SX to 1000BASE-SX, 1000BASE-LX to 1000BASE-LX.
2. Check whether the fiber-optic cable type matches the SFP transceiver model.
  - To connect to 1000BASE-SX SFP transceiver, use the multi-mode fiber cable -- with one side being the male duplex LC connector type.
  - To connect to 1000BASE-LX SFP transceiver, use the single-mode fiber cable -- with one side being the male duplex LC connector type.

### Connecting the fiber cable

1. Attach the duplex LC connector on the network cable to the SFP transceiver.
2. Connect the other end of the cable to a device – switches with SFP installed, fiber NIC on a workstation or a media converter.
3. Check the LNK/ACT LED of the SFP slot on the front of the **Industrial Managed Switch**. Ensure that the SFP transceiver is operating correctly.

### 100BASE-FX:

Before connecting the other switches, workstation or media converter,

1. Make sure both sides of the SFP transceiver are with the same media type or WDM pair, for example: 100BASE-FX to 100BASE-FX, 100BASE-BX20-U to 100BASE-BX20-D.
2. Check whether the fiber-optic cable type matches the SFP transceiver model.
  - To connect to MFB-FX SFP transceiver, use the multi-mode fiber cable -- with one side being the male duplex LC connector type.
  - To connect to MFB-F20/F40/F60/FA20/FB20 SFP transceiver, use the single-mode fiber cable -- with one side being the male duplex LC connector type.

### Connecting the fiber cable

1. Attach the duplex LC connector on the network cable to the SFP transceiver.
2. Connect the other end of the cable to a device – switches with SFP installed, fiber NIC on a workstation or a media converter.
3. Check the LNK/ACT LED of the SFP slot of the switch / converter. Ensure that the SFP transceiver is operating correctly.

4. Check the Link mode of the SFP port if the link fails. It can function with some fiber-NICs or media converters, and set the Link mode to “100 Force” when needed.

### 2.2.5 Removing the SFP Transceiver (For IGS-4215-4P4T2S)

1. Make sure there is no network activity by consulting or checking with the network administrator. Or through the management interface of the switch/converter (if available) to disable the port in advance.
2. Remove the fiber optic cable gently.
3. Turn the lever of the MGB / MFB module to a horizontal position.
4. Pull out the module gently through the lever.

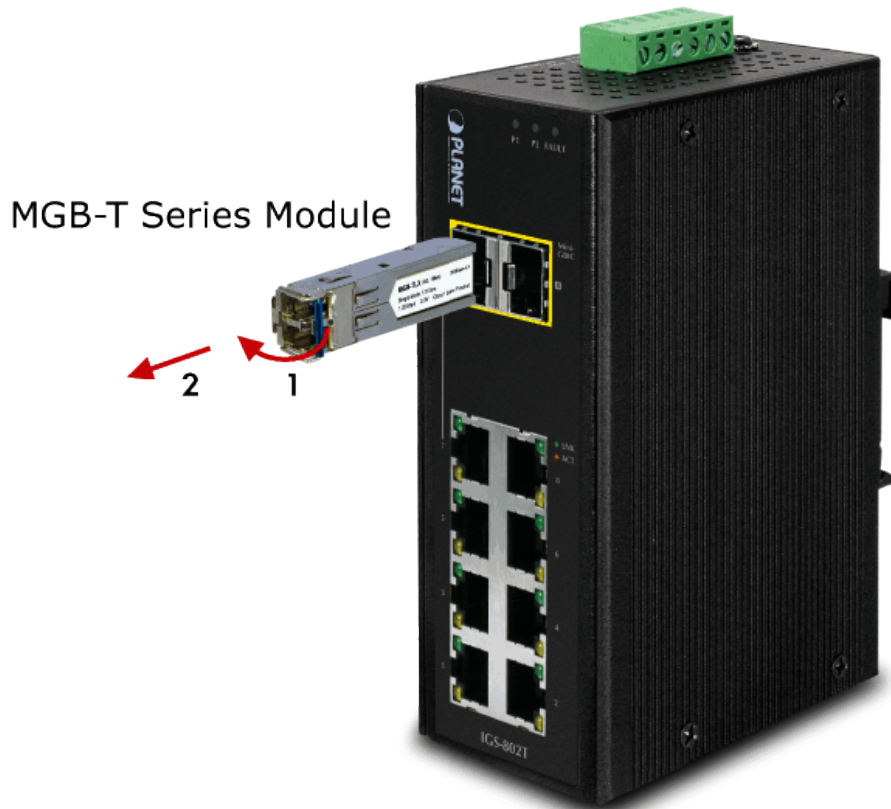

**Figure 2-10:** Pull out the SFP Transceiver Module



Never pull out the module without pulling the lever or the push bolts on the module. Directly pulling out the module with force could damage the module and SFP module slot of the device.

## 3. SWITCH MANAGEMENT

This chapter explains the methods that you can use to configure management access to the Industrial Managed Switch. It describes the types of management applications and the communication and management protocols that deliver data between your management device (workstation or personal computer) and the system. It also contains information about port connection options.

**This chapter covers the following topics:**

- Requirements
- Management Access Overview
- Administration Console Access
- Web Management Access
- SNMP Access
- Standards, Protocols, and Related Reading

### 3.1 Requirements

- **Workstations** running Windows 2000/XP, 2003, Vista/7/8, 2008, MAC OS9 or later, Linux, UNIX or other platforms are compatible with **TCP/IP** protocols.
- **Workstation** is installed with **Ethernet NIC** (Network Interface Card).
- **Serial Port** connect (Terminal)
  - The above PC comes with COM Port (DB9/RS-232) or USB-to-RS-232 converter
- Ethernet Port connection
  - Network cables -- Use standard network (UTP) cables with RJ45 connectors.
- The above Workstation is installed with **Web browser** and **Java runtime environment** plug-in.



---

It is recommended to use Internet Explorer 8.0 or above to access Industrial Managed Switch.

---



### 3.2 Management Access Overview

The Industrial Managed Switch gives you the flexibility to access and manage it using any or all of the following methods:

- An administration **console**
- **Web browser** interface
- An external **SNMP-based network management application**

The administration console and Web browser interfaces are embedded in the Industrial Managed Switch software and are available for immediate use. Each of these management methods has their own advantages. Table 3-1 compares the three management methods.

Method	Advantages	Disadvantages
<b>Console</b>	<ul style="list-style-type: none"> <li>• No IP address or subnet needed</li> <li>• Text-based</li> <li>• Telnet functionality and HyperTerminal built into Windows 95/98/NT/2000/ME/XP operating systems</li> <li>• Secure</li> </ul>	<ul style="list-style-type: none"> <li>• Must be near the switch or use dial-up connection</li> <li>• Not convenient for remote users</li> <li>• Modem connection may prove to be unreliable or slow</li> </ul>
<b>Web Browser</b>	<ul style="list-style-type: none"> <li>• Ideal for configuring the switch remotely</li> <li>• Compatible with all popular browsers</li> <li>• Can be accessed from any location</li> <li>• Most visually appealing</li> </ul>	<ul style="list-style-type: none"> <li>• Security can be compromised (hackers need to only know the IP address and subnet mask)</li> <li>• May encounter lag times on poor connections</li> </ul>
<b>SNMP Agent</b>	<ul style="list-style-type: none"> <li>• Communicates with switch functions at the MIB level</li> <li>• Based on open standards</li> </ul>	<ul style="list-style-type: none"> <li>• Requires SNMP manager software</li> <li>• Least visually appealing of all three methods</li> <li>• Some settings require calculations</li> <li>• Security can be compromised (hackers need to only know the community name)</li> </ul>

**Table 3-1** Comparison of Management Methods

### 3.3 Administration Console

The administration console is an internal, character-oriented, and command line user interface for performing system administration such as displaying statistics or changing option settings. Using this method, you can view the administration console from a terminal, personal computer, Apple Macintosh, or workstation connected to the Industrial Managed Switch's console port.

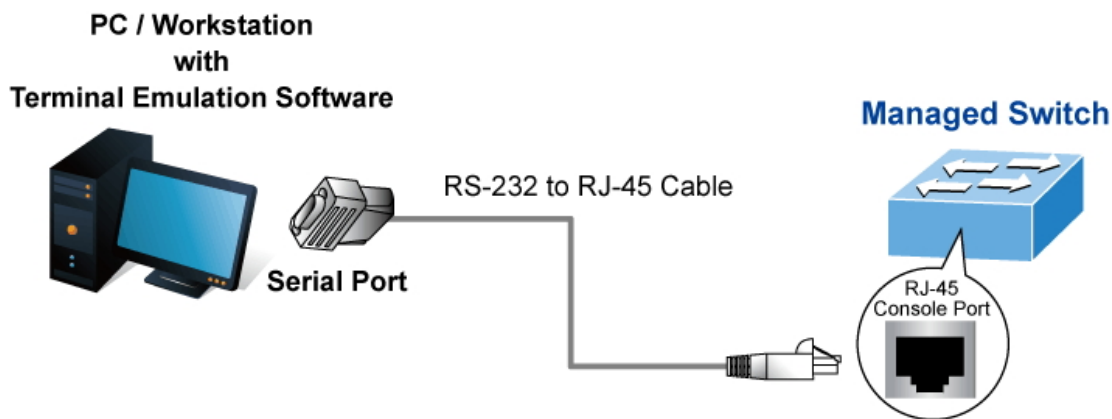

Figure 3-1-1: Console Management

#### Direct Access

Direct access to the administration console is achieved by directly connecting a terminal or a PC equipped with a terminal-emulation program (such as **HyperTerminal**) to the Industrial Managed Switch console (serial) port. When using this management method, a **straight RS-232 to RJ45 cable** is required to connect the switch to the PC. After making this connection, configure the terminal-emulation program to use the following parameters:

The default parameters are:

- 115200 bps
- 8 data bits
- No parity
- 1 stop bit

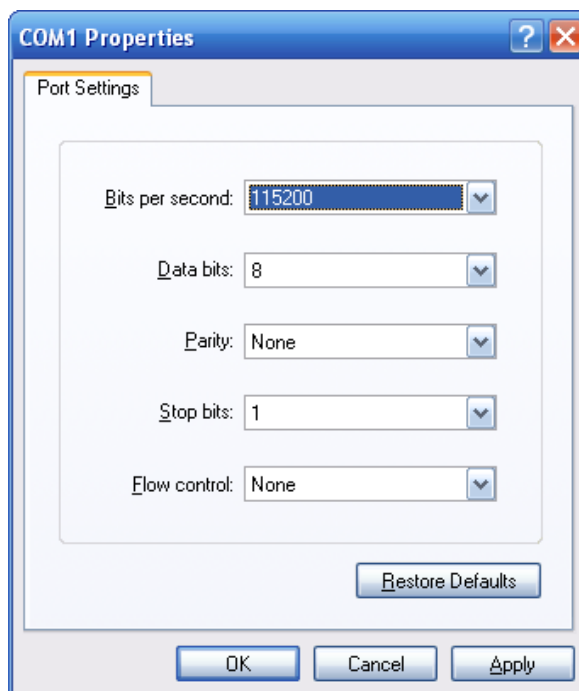

Figure 3-1-2: Terminal Parameter Settings

You can change these settings, if desired, after you log on. This management method is often preferred because you can remain connected and monitor the system during system reboots. Also, certain error messages are sent to the serial port, regardless of the interface through which the associated action was initiated. A Macintosh or PC attachment can use any terminal-emulation program for connecting to the terminal serial port. A workstation attachment under UNIX can use an emulator such as TIP.

### 3.4 Web Management

The Industrial Managed Switch offers management features that allow users to manage the Industrial Managed Switch from anywhere on the network through a standard browser such as Microsoft Internet Explorer. After you set up your IP address for the switch, you can access the Industrial Managed Switch's Web interface applications directly in your Web browser by entering the IP address of the Industrial Managed Switch.

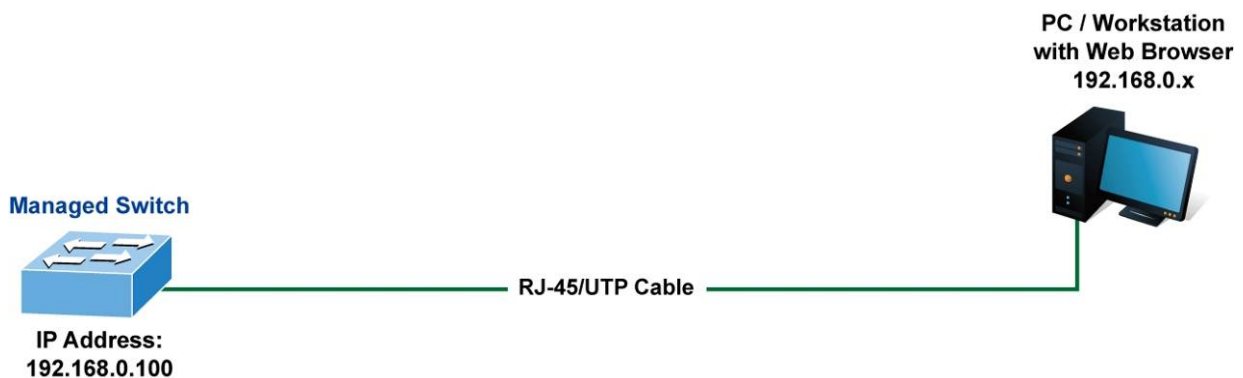

Figure 3-1-3 Web Management

You can then use your Web browser to list and manage the Industrial Managed Switch configuration parameters from one central location, just as if you were directly connected to the Industrial Managed Switch's console port. Web Management requires either **Microsoft Internet Explorer 8.0** or later, **Google Chrome**, **Safari** or **Mozilla Firefox 1.5** or later.



Figure 3-1-4 Web Main Screen of Industrial Managed Switch

### 3.5 SNMP-based Network Management

You can use an external SNMP-based application to configure and manage the Industrial Managed Switch, such as SNMPc Network Manager, HP Openview Network Node Management (NNM) or What's Up Gold. This management method requires the SNMP agent on the switch and the SNMP Network Management Station to use the **same community string**. This management method, in fact, uses two community strings: the **get community** string and the **set community** string. If the SNMP Network management Station only knows the set community string, it can read and write to the MIBs. However, if it only knows the get community string, it can only read MIBs. The default gets and sets community strings for the Industrial Managed Switch are public.

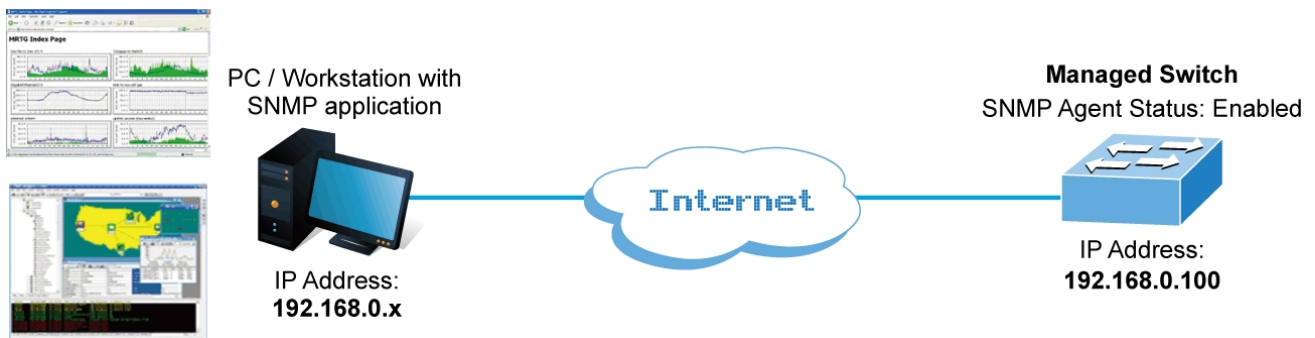

Figure 3-1-5 SNMP Management

### 3.6 PLANET Smart Discovery Utility

For easily listing the Industrial Managed Switch in your Ethernet environment, the Planet Smart Discovery Utility from user's manual CD-ROM is an ideal solution. The following installation instructions are to guide you to running the Planet Smart Discovery Utility.

1. Deposit the Planet Smart Discovery Utility in administrator PC.
2. Run this utility as the following screen appears.

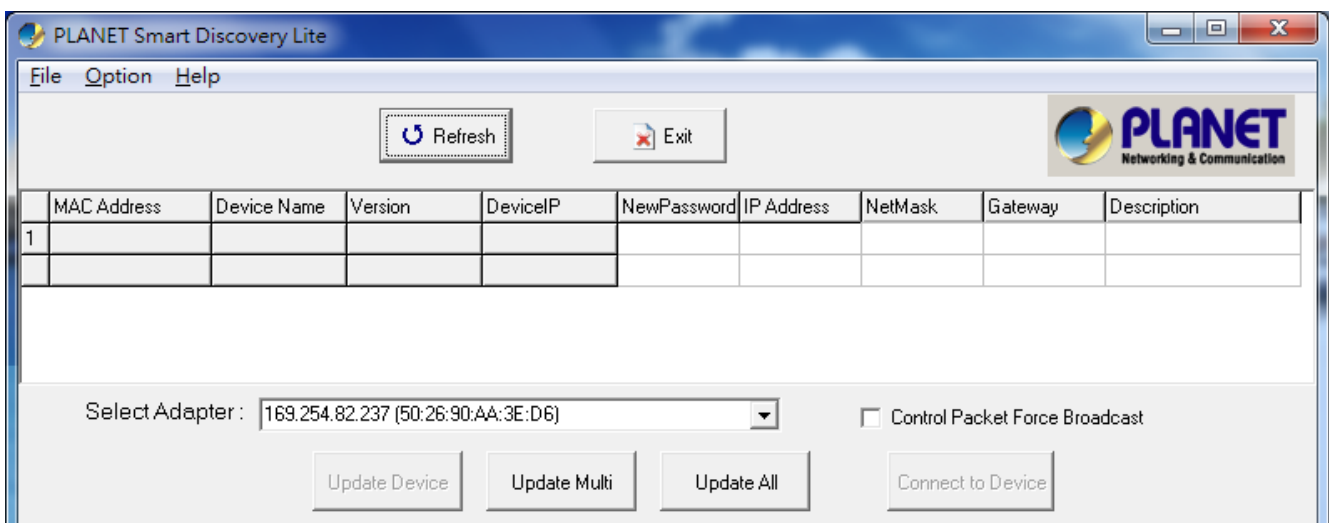
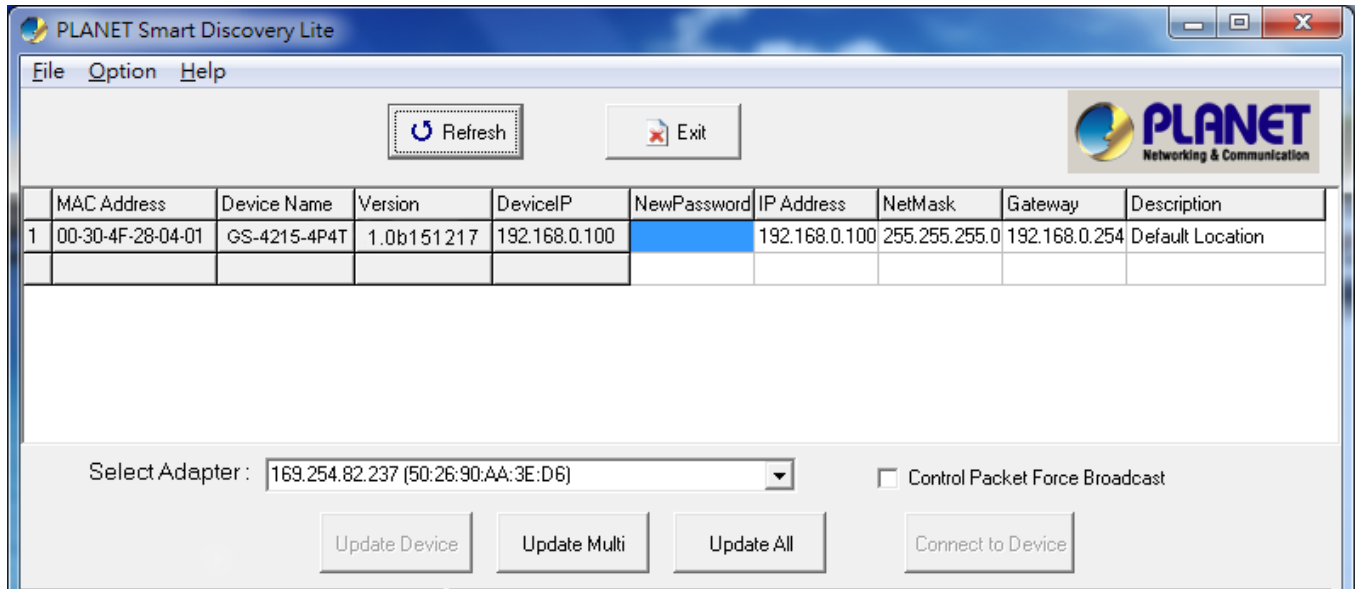

Figure 3-1-6: Planet Smart Discovery Utility Screen



If there are two LAN cards or above in the same administrator PC, choose a different LAN card by using the **“Select Adapter”** tool.

3. Press the **“Refresh”** button for the currently connected devices in the discovery list as the screen shows below:



**Figure 3-1-7:** Planet Smart Discovery Utility Screen

1. This utility shows all necessary information from the devices, such as MAC address, device name, firmware version and device IP subnet address. It can also assign new password, IP subnet address and description to the devices.
2. After setup is completed, press the **“Update Device”**, **“Update Multi”** or **“Update All”** button to take effect. The meaning of the 3 buttons above are shown below:
  - **Update Device:** Use the current setting on one single device.
  - **Update Multi:** Use the current setting on multi-devices.
  - **Update All:** Use the current setting on whole devices in the list.

The same functions mentioned above also can be found in **“Option”** tools bar.

3. To click the **“Control Packet Force Broadcast”** function, it allows you to assign a new setting value to the Web Smart Switch under a different IP subnet address.
4. Press the **“Connect to Device”** button and the Web login screen appears in [Figure 3-1-4](#).
5. Press the **“Exit”** button to shut down the Planet Smart Discovery Utility.

## 4. WEB CONFIGURATION

This section introduces the configuration and functions of the Web-based management.

### About Web-based Management

The Industrial Managed Switch offers management features that allow users to manage the Industrial Managed Switch from anywhere on the network through a standard browser such as Microsoft Internet Explorer.

The Web-based Management supports Internet Explorer 8.0. It is based on Java Applets with an aim to reduce network bandwidth consumption, enhance access speed and present an easy viewing screen.



By default, IE8.0 or later version does not allow Java Applets to open sockets. The user has to explicitly modify the browser setting to enable Java Applets to use network ports.

The Industrial Managed Switch can be configured through an Ethernet connection, making sure the manager PC must be set on the same IP subnet address as the Industrial Managed Switch.

For example, the default IP address of the Industrial Managed Switch is **192.168.0.100**, then the manager PC should be set at **192.168.0.x** (where x is a number between 1 and 254, except 100), and the default subnet mask is 255.255.255.0.

If you have changed the default IP address of the Industrial Managed Switch to 192.168.1.1 with subnet mask 255.255.255.0 via console, then the manager PC should be set at 192.168.1.x (where x is a number between 2 and 254) to do the relative configuration on manager PC.

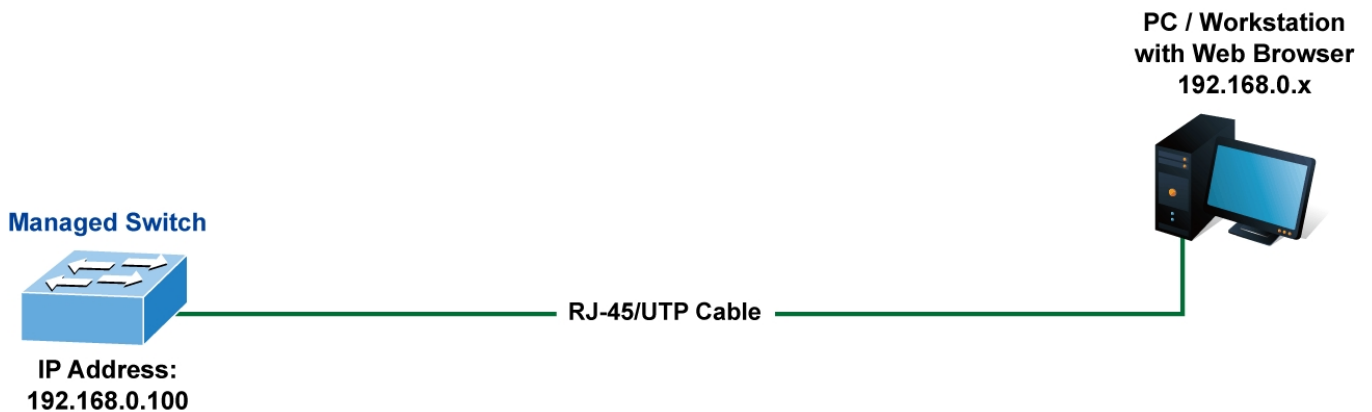

Figure 4-1-1 Web Management

#### ■ Logging on the switch

1. Use Internet Explorer 8.0 or above Web browser. Enter the factory-default IP address to access the Web interface. The factory-default IP address is as follows:

<http://192.168.0.100>

- When the following login screen appears, please enter the default username "**admin**" with password "**admin**" (or the username/password you have changed via console) to login the main screen of Industrial Managed Switch. The login screen in [Figure 4-1-2](#) appears.

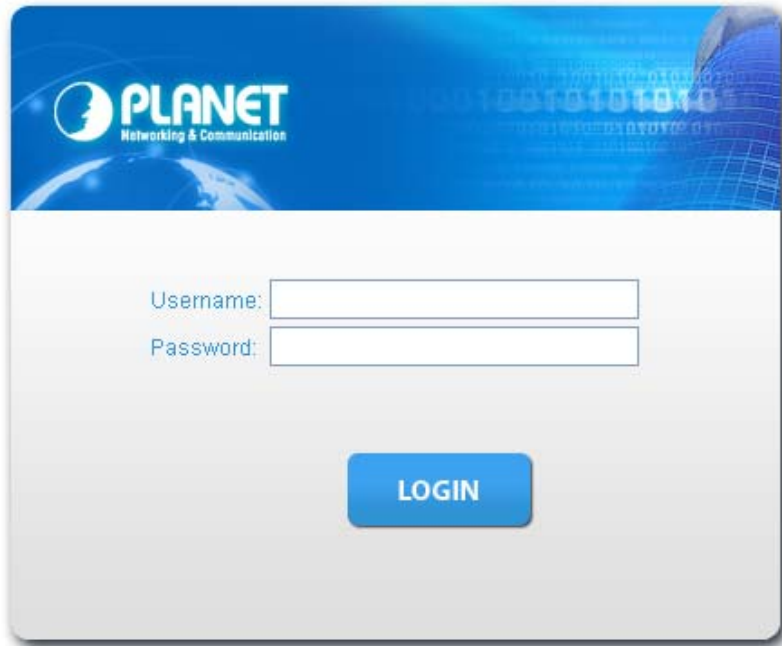

Figure 4-1-2 Login screen

Default User Name: **admin**

Default Password: **admin**

After entering the username and password, the main screen appears as [Figure 4-1-3](#).



Figure 4-1-3 Default Main Page



Now, you can use the Web management interface to continue the switch management or manage the Industrial Managed Switch by Web interface. The Switch Menu on the left of the web page lets you access all the commands and statistics the Industrial Managed Switch provides.



Note

- 
- It is recommended to use Internet Explorer 8.0 or above to access Industrial Managed Switch.
  - The changed IP address takes effect immediately after clicking on the **Save** button. You need to use the new IP address to access the Web interface.
- 



Note

- 
- For security reason, please change and memorize the new password after this first setup.
  - Only accept command in lowercase letter under Web interface.
-

## 4.1 Main Web Page

The Industrial Managed Switch provides a Web-based browser interface for configuring and managing it. This interface allows you to access the Industrial Managed Switch using the Web browser of your choice. This chapter describes how to use the Industrial Managed Switch's Web browser interface to configure and manage it.

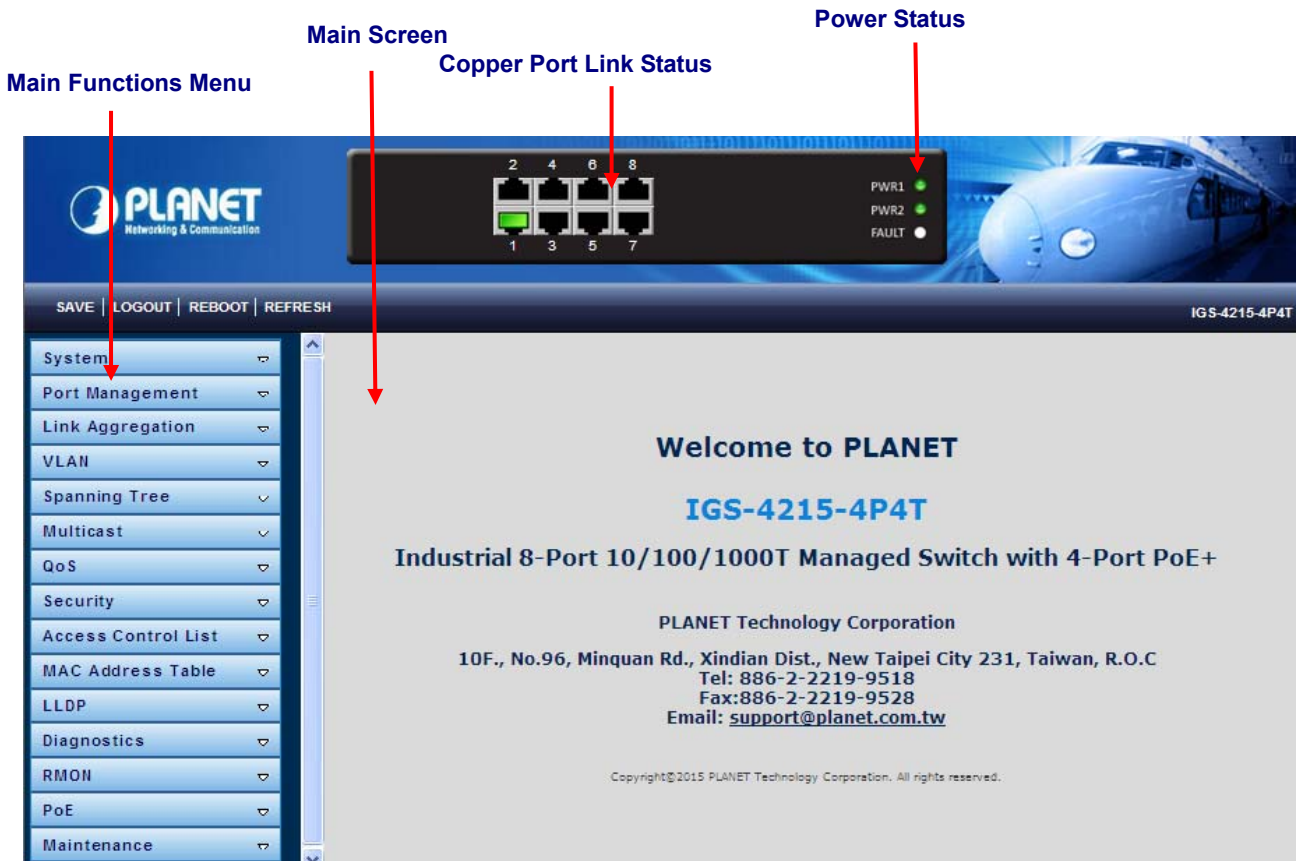

Figure 4-1-4 Main Page

### Panel Display

The Web agent displays an image of the Industrial Managed Switch's ports. The Mode can be set to display different information for the ports, including Link up or Link down. Clicking on the image of a port opens the **Port Statistics** page.

The port states are illustrated as follows:

State	Disabled	Down	Link
RJ45 Ports			
SFP Ports			

### Main Menu

Using the onboard Web agent, you can define system parameters, manage and control the Industrial Managed Switch, and all its ports, or monitor network conditions. Via the Web-Management, the administrator can set up the Industrial Managed Switch by selecting the functions those listed in the Main Function. The screen in [Figure 4-1-5](#) appears.

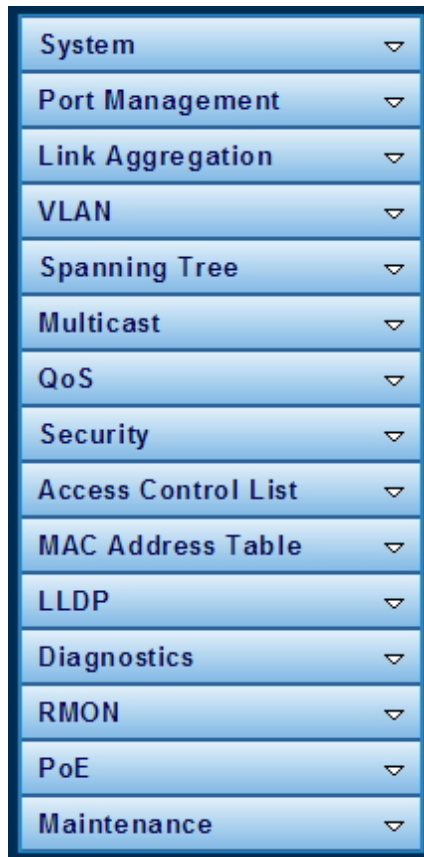

Figure 4-1-5 Industrial Managed Switch Main Functions Menu

**Buttons**

**SAVE**: Click to save changes or reset to default.

**LOGOUT**: Click to log out the Industrial Managed Switch.

**REBOOT**: Click to reboot the Industrial Managed Switch.

**REFRESH**: Click to refresh the page.

**4.1.1 Save Button**

This save button allows you to save the running/startup/backup configuration or reset switch in default parameter. The screen in [Figure 4-1-6](#) appears.

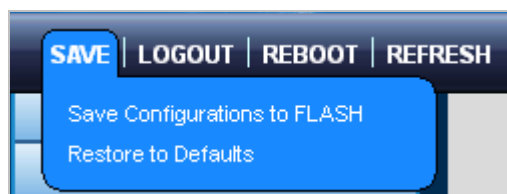

Figure 4-1-6 Save Button Screenshot

The page includes the following fields:

Object	Description
<ul style="list-style-type: none"> <li>• <b>Save Configuration to FLASH</b></li> </ul>	Click to save the configuration. For more detailed information, please refer to chapter 4.1.2
<ul style="list-style-type: none"> <li>• <b>Restore to Default</b></li> </ul>	Click to reset switch in default parameter. For more detailed information, please refer to chapter 4.15.1

### 4.1.2 Configuration Manager

The system file folder contains configuration settings. The screen in [Figure 4-1-7](#) appears.

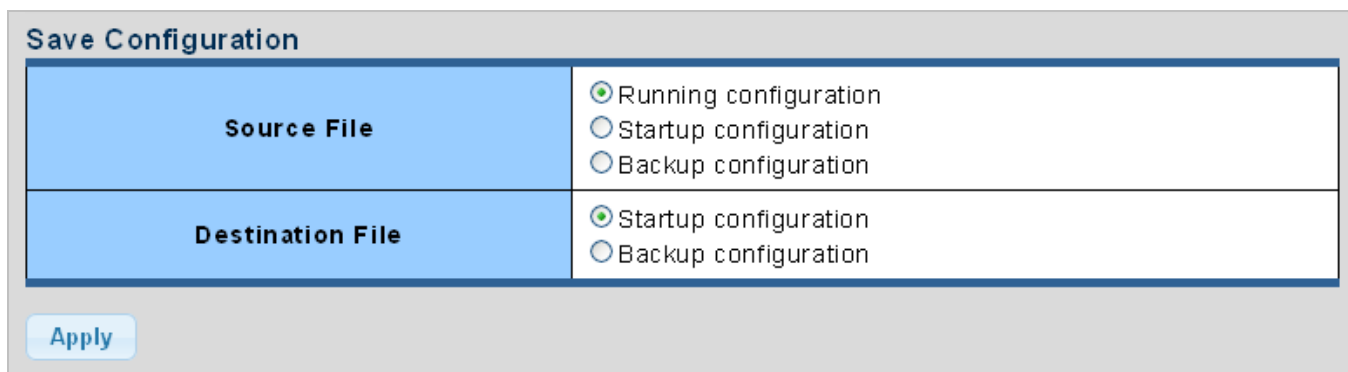



Figure 4-1-7 Save Button Screenshot

The page includes the following fields:

Object	Description
<ul style="list-style-type: none"> <li>• <b>Running Configuration</b></li> </ul>	<p>Refers to the running configuration sequence use in the switch.</p> <p>In switch, the running configuration file stores in the RAM. In the current version, the running configuration sequence running-config can be saved from the RAM to FLASH by saving “<b>Source File = Running Configuration</b>” to “<b>Destination File = Startup Configuration</b>”, so that the running configuration sequence becomes the startup configuration file, which is called configuration save.</p> <p>To prevent illicit file upload and easier configuration, switch mandates the name of running configuration file to be running-config.</p>
<ul style="list-style-type: none"> <li>• <b>Startup Configuration</b></li> </ul>	<p>Refers to the configuration sequence used in switch startup.</p> <p>Startup configuration file stores in nonvolatile storage, corresponding to the so-called configuration save. If the device supports multi-config file, name the configuration file to be .cfg file, the default is startup.cfg.</p> <p>If the device does not support multi-config file, mandates the name of startup configuration file to be startup-config.</p>
<ul style="list-style-type: none"> <li>• <b>Backup Configuration</b></li> </ul>	The backup configuration is empty in FLASH; please save the backup configuration first by “ <b>Maintenance &gt; Backup Manager</b> ”.

**Buttons**

: Click to save configuration.

**4.1.2.1 Saving Configuration**

In the Industrial Managed Switch, the running configuration file stores in the RAM. In the current version, the running configuration sequence of running-config can be saved from the RAM to FLASH by "Save Configurations to FLASH" function, so that the running configuration sequence becomes the startup configuration file, which is called configuration save.

To save all applied changes and set the current configuration as a startup configuration. The startup-configuration file will be loaded automatically across a system reboot.

1. Click "Save > Save Configurations to FLASH" to login "Configuration Manager" page.

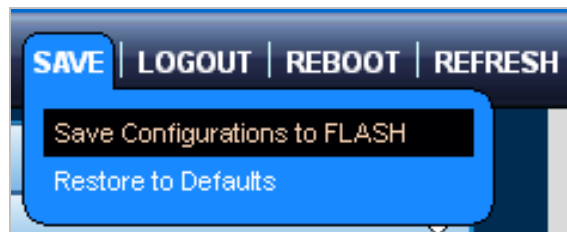

2. Select "Source File = Running Configuration" and "Destination File = Startup Configuration".

Save Configuration	
<b>Source File</b>	<input checked="" type="radio"/> Running configuration <input type="radio"/> Startup configuration <input type="radio"/> Backup configuration
<b>Destination File</b>	<input checked="" type="radio"/> Startup configuration <input type="radio"/> Backup configuration



3. Press the "Apply" button to save running configuration to startup configuration.

## 4.2 System

Use the System menu items to display and configure basic administrative details of the Industrial Managed Switch. Under System the following topics are provided to configure and view the system information. This section has the following items:

- **System Information**            The switch system information is provided here.
- **IP Configurations**            Configure the switch-managed IP information on this page.
- **IPv6 Configuration**          Configure the switch-managed IPv6 information on this page.
- **User Configuration**          Configure new user name and password on this page.
- **Time Settings**                Configure SNTP on this page.
- **Log Management**            The switch log information is provided here.
- **SNMP Management**          Configure SNMP on this page.
- **Fault Alarm Configuration**   Configure Fault Alarm on this page.

### 4.2.1 System Information

The System Info page provides information for the current device information. System Info page helps a switch administrator to identify the hardware MAC address, software version and system uptime. The screens in [Figure 4-2-1](#) & [Figure 4-2-2](#) appear.

System Information	
Information Name	Information Value
System Name	<a href="#">Edit</a> IGS-4215-4P4T
System Location	<a href="#">Edit</a> Default Location
System Contact	<a href="#">Edit</a> Default Contact
MAC Address	00:E0:4C:11:22:33
IP Address	192.168.0.100
Subnet Mask	255.255.255.0
Gateway	192.168.0.254
Loader Version	1.0.0.48161
Loader Date	Sep 14 2015 - 15:57:50
Firmware Version	1.0b151127
Firmware Date	Nov 30 2015 - 14:30:23
System Object ID	1.3.6.1.4.1.10456.9.31
System Up Time	0 days, 3 hours, 33 mins, 16 secs
PCB/HW Version	V1
Power Status	DC PWR1: ON DC PWR2: ON
Temperature	37°C / 98°F

Figure 4-2-1 System Information Page Screenshot

The page includes the following fields:

Object	Description
• <b>System Name</b>	Display the current system name
• <b>System Location</b>	Display the current system location
• <b>System Contact</b>	Display the current system contact
• <b>MAC Address</b>	The MAC address of this Industrial Managed Switch.
• <b>IP Address</b>	The IP address of this Industrial Managed Switch.
• <b>Subnet Mask</b>	The subnet mask of this Industrial Managed Switch.
• <b>Gateway</b>	The gateway of this Industrial Managed Switch.
• <b>Loader Version</b>	The loader version of this Industrial Managed Switch.
• <b>Loader Date</b>	The loader date of this Industrial Managed Switch.
• <b>Firmware Version</b>	The firmware version of this Industrial Managed Switch.
• <b>Firmware Date</b>	The firmware date of this Industrial Managed Switch.
• <b>System Object ID</b>	The system object ID of the Industrial Managed Switch.
• <b>System Up Time</b>	The period of time the device has been operational.
• <b>PCN/HW Version</b>	The hardware version of this Industrial Managed Switch.
• <b>Power Status</b>	The Current Status of power input for DC1 and DC2.
• <b>Temperature</b>	The Current Temperature of Industrial Managed Switch.

**Buttons**



: Click to edit parameter.



## 4.2.2 IP Configurations

The IP Configuration includes the IP Address, Subnet Mask and Gateway. The configured column is used to view or change the IP configuration. Fill out the IP Address, Subnet Mask and Gateway for the device. The screens in [Figure 4-2-2](#) & [Figure 4-2-3](#) appear.

### IP Address Setting

<b>Mode</b>	<input checked="" type="radio"/> Static <input type="radio"/> DHCP
<b>IP Address</b>	<input type="text" value="192.168.1.1"/>
<b>Subnet Mask</b>	<input type="text" value="255.255.255.0"/>
<b>Gateway</b>	<input type="text" value="192.168.1.254"/>
<b>DNS Server 1</b>	<input type="text" value="168.95.1.1"/>
<b>DNS Server 2</b>	<input type="text" value="168.95.192.1"/>

Figure 4-2-2 IP Address Setting Page Screenshot

The page includes the following fields:

Object	Description
<ul style="list-style-type: none"> <li>• <b>Mode</b></li> </ul>	<p>Indicates the IP address mode operation. Possible modes are:</p> <p><b>Static:</b> Enable NTP mode operation.</p> <p>When enabling NTP mode operation, the agent forwards and transfers NTP messages between the clients and the server when they are not on the same subnet domain.</p> <p><b>DHCP:</b> Enable DHCP client mode operation.</p> <p>Enable the DHCP client by checking this box. If DHCP fails and the configured IP address is zero, DHCP will retry. If DHCP fails and the configured IP address is non-zero, DHCP will stop and the configured IP settings will be used. The DHCP client will announce the configured System Name as hostname to provide DNS lookup.</p>
<ul style="list-style-type: none"> <li>• <b>IP Address</b></li> </ul>	Provides the IP address of this switch in dotted decimal notation.
<ul style="list-style-type: none"> <li>• <b>Subnet Mask</b></li> </ul>	Provides the subnet mask of this switch in dotted decimal notation.
<ul style="list-style-type: none"> <li>• <b>Gateway</b></li> </ul>	Provides the IP address of the router in dotted decimal notation.
<ul style="list-style-type: none"> <li>• <b>DNS Server 1/2</b></li> </ul>	Provides the IP address of the DNS Server in dotted decimal notation.

**Buttons**

: Click to apply changes.

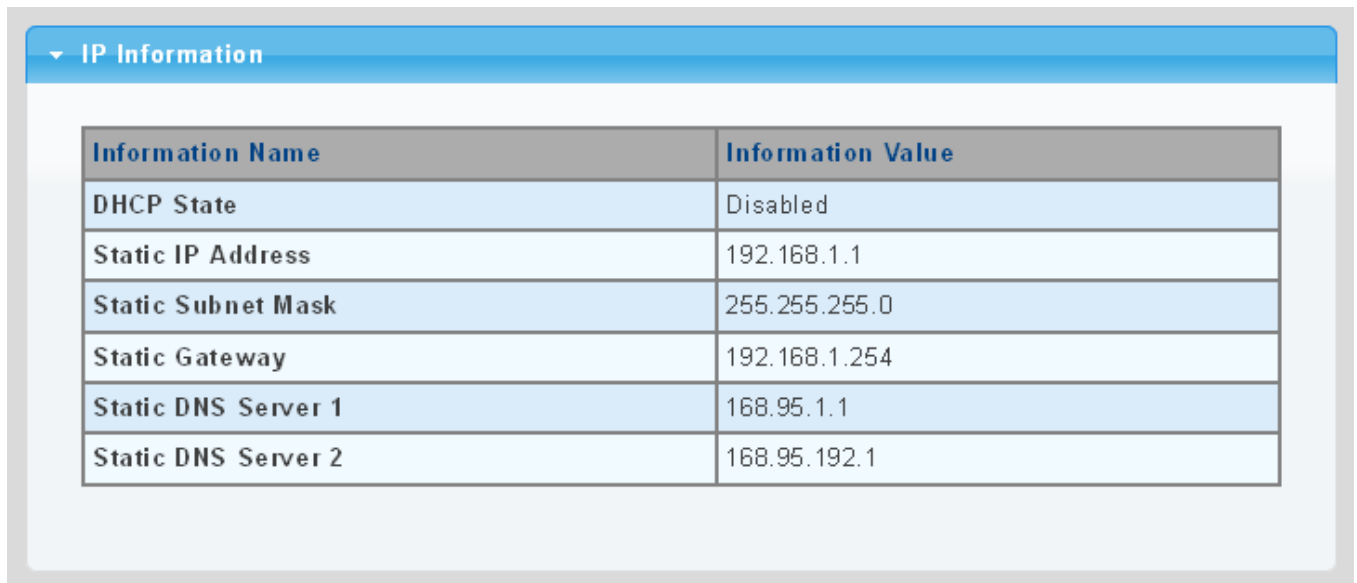

**Figure 4-2-3** IP Information Page Screenshot

The page includes the following fields:

Object	Description
• <b>DHCP State</b>	Displays the current DHCP state.
• <b>IP Address</b>	Displays the current IP address.
• <b>Subnet Mask</b>	Displays the current subnet mask.
• <b>Gateway</b>	Displays the current gateway.
• <b>DNS Server 1/2</b>	Displays the current DNS server.

### 4.2.3 IPv6 Configuration

The IPv6 Configuration includes Auto Configuration, IPv6 Address and Gateway. The configured column is used to view or change the IPv6 configuration. Fill out the Auto Configuration, IPv6 Address and Gateway for the device. The screens in [Figure 4-2-4](#) & [Figure 4-2-5](#) appear.

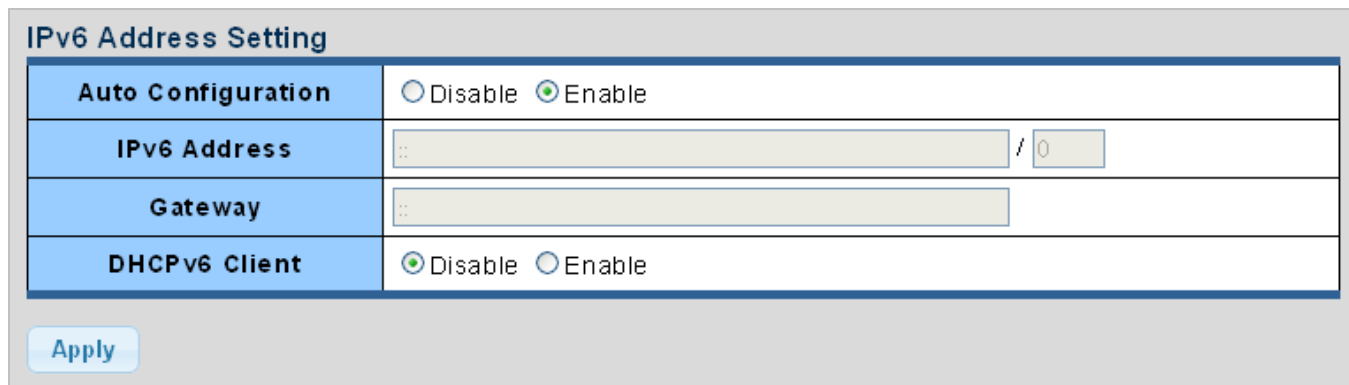

Figure 4-2-4 IPv6 Address Setting Page Screenshot

The page includes the following fields:

Object	Description
<ul style="list-style-type: none"> <li>• <b>Auto Configuration</b></li> </ul>	<p>Enable IPv6 auto-configuration by checking this box.</p> <p>If it fails, the configured IPv6 address is zero. The router may delay responding to a router solicitation for a few seconds; the total time needed to complete auto-configuration can be significantly longer.</p>
<ul style="list-style-type: none"> <li>• <b>IPv6 Address</b></li> </ul>	<p>Provide the IPv6 address of this switch.</p> <p>IPv6 address is in 128-bit records represented as eight fields of up to four hexadecimal digits with a colon separating each field (:). For example, 'fe80::215:c5ff:fe03:4dc7'.</p> <p>The symbol '::' is a special syntax that can be used as a shorthand way of representing multiple 16-bit groups of contiguous zeros; but it can only appear once. It also uses the following legally IPv4 address. For example, ':192.1.2.34'.</p> <p>Provide the IPv6 Prefix of this switch. The allowed range is 1 through 128.</p>
<ul style="list-style-type: none"> <li>• <b>Gateway</b></li> </ul>	<p>Provide the IPv6 gateway address of this switch.</p> <p>IPv6 address is in 128-bit records represented as eight fields of up to four hexadecimal digits with a colon separating each field (:). For example, 'fe80::215:c5ff:fe03:4dc7'.</p>
<ul style="list-style-type: none"> <li>• <b>DHCPv6 Client</b></li> </ul>	<p>To enable this Industrial Managed Switch to accept a configuration from a <b>Dynamic Host Configuration Protocol version 6 (DHCPv6)</b> server. By default, the Industrial Managed Switch does not perform DHCPv6 client actions. DHCPv6 clients request the delegation of long-lived prefixes that they can push to individual local hosts.</p>

**Buttons**

**Apply** : Click to apply changes.

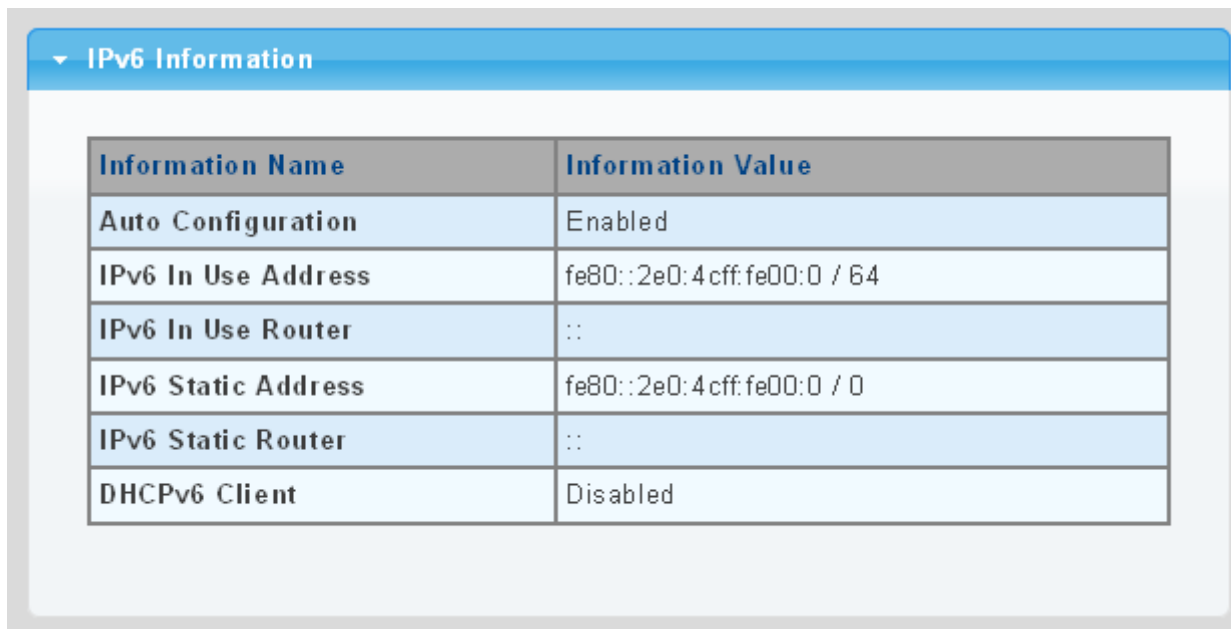

IPv6 Information	
Information Name	Information Value
Auto Configuration	Enabled
IPv6 In Use Address	fe80::2e0:4cff:fe00:0 / 64
IPv6 In Use Router	::
IPv6 Static Address	fe80::2e0:4cff:fe00:0 / 0
IPv6 Static Router	::
DHCPv6 Client	Disabled

**Figure 4-2-5 IPv6 Information Page Screenshot**

The page includes the following fields:

Object	Description
• <b>Auto Configuration</b>	Displays the current auto configuration state
• <b>IPv6-in-Use Address</b>	Displays the currently-used IPv6 address
• <b>IPv6-in-Use Router</b>	Displays the currently-used gateway
• <b>IPv6 Static Address</b>	Displays the current IPv6 static address
• <b>IPv6 Static Router</b>	Displays the current IPv6 static gateway
• <b>DHCPv6 Client</b>	Displays the current DHCPv6 client status

### 4.2.4 User Configuration

This page provides an overview of the current users and privilege type. Currently the only way to login as another user on the Web server is to close and reopen the browser. After the setup is completed, please press the “Apply” button to take effect. Please login Web interface with a new user name and password; the screens in [Figure 4-2-6](#) & [Figure 4-2-7](#) appear.

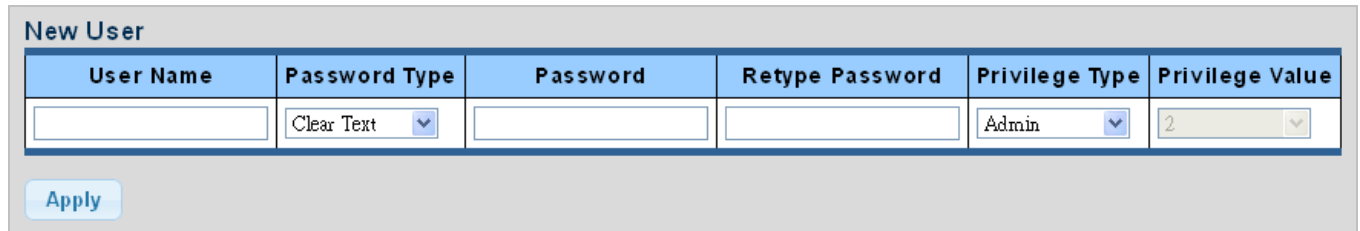

Figure 4-2-6 Local User Information Page Screenshot

The page includes the following fields:

Object	Description
• Username	The name identifying the user. Maximum length: <b>32</b> characters; Maximum number of users: <b>8</b>
• Password Type	The password type for the user.
• Password	Enter the user's new password here. (Range: 0-32 characters plain text, case sensitive)
• Retype Password	Please enter the user's new password here again to confirm.
• Privilege Type	The privilege type for the user. Options: <ul style="list-style-type: none"> <li>• Admin</li> <li>• User</li> <li>• Other</li> </ul>

#### Buttons

: Click to apply changes.

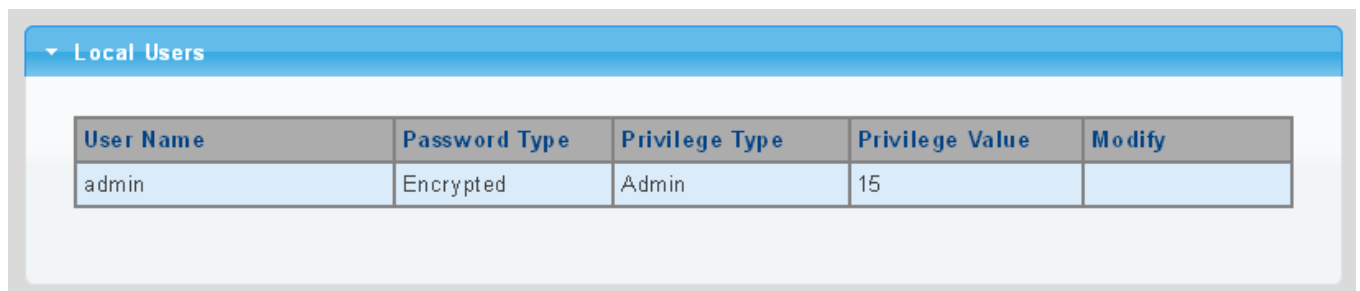

Figure 4-2-7 Local User Page Screenshot

The page includes the following fields:

Object	Description
--------	-------------

• Username	Displays the current username
• Password Type	Displays the current password type
• Privilege Type	Displays the current privilege type
• Modify	Click to modify the local user entry <input type="button" value="Delete"/> : Delete the current user

## 4.2.5 Time Settings

### 4.2.5.1 System Time

Configure SNTP on this page. **SNTP** is an acronym for **Simple Network Time Protocol**, a network protocol for synchronizing the clocks of computer systems. You can specify SNTP Servers and set GMT Time zone. The SNTP Configuration screens in [Figure 4-2-8](#) & [Figure 4-2-9](#) appear.

#### System Time Setting

<b>Enable SNTP</b>	<input checked="" type="radio"/> Disable <input type="radio"/> Enable
<b>Manual Time</b>	Year <input type="text" value="2000"/> Month <input type="text" value="Jan"/> Day <input type="text" value="1"/> Hours <input type="text" value="0"/> Minutes <input type="text" value="0"/> Seconds <input type="text" value="0"/>
<b>Time Zone</b>	<input type="text" value="None"/>
<b>Daylight Saving Time</b>	<input type="text" value="Disable"/>
<b>Daylight Saving Time Offset</b>	<input type="text" value="60"/> ( 1 - 1440 ) Minutes
<b>Recurring From</b>	Day <input type="text" value="Sun"/> Week <input type="text" value="1"/> Month <input type="text" value="Jan"/> Hours <input type="text" value="0"/> Minutes <input type="text" value="0"/>
<b>Recurring To</b>	Day <input type="text" value="Sun"/> Week <input type="text" value="1"/> Month <input type="text" value="Jan"/> Hours <input type="text" value="0"/> Minutes <input type="text" value="0"/>
<b>Non-recurring From</b>	Year <input type="text" value="2000"/> Month <input type="text" value="Jan"/> Date <input type="text" value="1"/> Hours <input type="text" value="0"/> Minutes <input type="text" value="0"/>
<b>Non-recurring To</b>	Year <input type="text" value="2000"/> Month <input type="text" value="Jan"/> Date <input type="text" value="1"/> Hours <input type="text" value="0"/> Minutes <input type="text" value="0"/>

Figure 4-2-8 SNTP Setup Page Screenshot

The page includes the following fields:

Object	Description
• Enable SNTP	<p><b>Enabled:</b> Enable SNTP mode operation.</p> <p>When enabling SNTP mode operation, the agent forwards and transfers SNTP messages between the clients and the server when they are not on the same subnet domain.</p> <p><b>Disabled:</b> Disable SNTP mode operation.</p>
• Manual Time	To set time manually.

	<ul style="list-style-type: none"> <li>• <b>Year</b> - Select the starting Year.</li> <li>• <b>Month</b> - Select the starting month.</li> <li>• <b>Day</b> - Select the starting day.</li> <li>• <b>Hours</b> - Select the starting hour.</li> <li>• <b>Minutes</b> - Select the starting minute.</li> <li>• <b>Seconds</b> - Select the starting seconds.</li> </ul>
• <b>Time Zone</b>	Allows to select the time zone according to the current location of switch.
• <b>Daylight Saving Time</b>	This is used to set the clock forward or backward according to the configurations set below for a defined Daylight Saving Time duration. Select 'Disable' to disable the Daylight Saving Time configuration. Select 'Recurring' and configure the Daylight Saving Time duration to repeat the configuration every year. Select 'Non-Recurring' and configure the Daylight Saving Time duration for single time configuration. (Default: Disabled).
• <b>Daylight Saving Time Offset</b>	Enter the number of minutes to add during Daylight Saving Time. ( Range: 1 to 1440 )
• <b>Recurring From</b>	<ul style="list-style-type: none"> <li>• <b>Week</b> - Select the starting week number.</li> <li>• <b>Day</b> - Select the starting day.</li> <li>• <b>Month</b> - Select the starting month.</li> <li>• <b>Hours</b> - Select the starting hour.</li> <li>• <b>Minutes</b> - Select the starting minute.</li> </ul>
• <b>Recurring To</b>	<ul style="list-style-type: none"> <li>• <b>Week</b> - Select the starting week number.</li> <li>• <b>Day</b> - Select the starting day.</li> <li>• <b>Month</b> - Select the starting month.</li> <li>• <b>Hours</b> - Select the starting hour.</li> <li>• <b>Minutes</b> - Select the starting minute.</li> </ul>
• <b>Non-recurring From</b>	<ul style="list-style-type: none"> <li>• <b>Week</b> - Select the starting week number.</li> <li>• <b>Day</b> - Select the starting day.</li> <li>• <b>Month</b> - Select the starting month.</li> <li>• <b>Hours</b> - Select the starting hour.</li> <li>• <b>Minutes</b> - Select the starting minute.</li> </ul>
• <b>Non-recurring To</b>	<ul style="list-style-type: none"> <li>• <b>Week</b> - Select the starting week number.</li> <li>• <b>Day</b> - Select the starting day.</li> <li>• <b>Month</b> - Select the starting month.</li> <li>• <b>Hours</b> - Select the starting hour.</li> <li>• <b>Minutes</b> - Select the starting minute.</li> </ul>



**Buttons**



: Click to apply changes.

System Time Informations	
Information Name	Information Value
Current Date/Time	09:13:10 DFL(UTC+8) Jan 01 2000
SNTP	Disabled
Time zone	UTC+8
Daylight Saving Time	Disabled
Daylight Saving Time Offset	
From	
To	

**Figure 4-2-9** Time Information Page Screenshot

The page includes the following fields:

Object	Description
• <b>Current Data/Time</b>	Displays the current data/time
• <b>SNTP</b>	Displays the current SNTP state
• <b>Time Zone</b>	Displays the current time zone
• <b>Daylight Saving Time</b>	Displays the current daylight saving time state
• <b>Daylight Saving Time Offset</b>	Displays the current daylight saving time offset state
• <b>From</b>	Displays the current daylight saving time from
• <b>To</b>	Displays the current daylight saving time to

### 4.2.5.2 SNTP Server Settings

The SNTP Server Configuration screens in [Figure 4-2-10](#) & [Figure 4-2-11](#) appear.

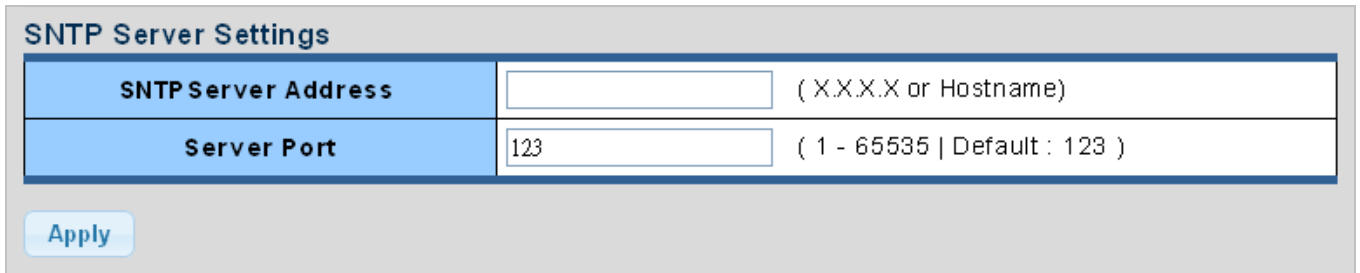

The screenshot shows a configuration form titled "SNTP Server Settings". It contains two input fields: "SNTP Server Address" with a placeholder "( X.X.X.X or Hostname )" and "Server Port" with a value of "123" and a range "( 1 - 65535 | Default : 123 )". An "Apply" button is located below the fields.

Figure 4-2-10 SNTP Setup Page Screenshot

The page includes the following fields:

Object	Description
• SNTP Server Address	Type the IP address or domain name of the SNTP server
• Server Port	Type the port number of the SNTP

#### Buttons



: Click to apply changes.

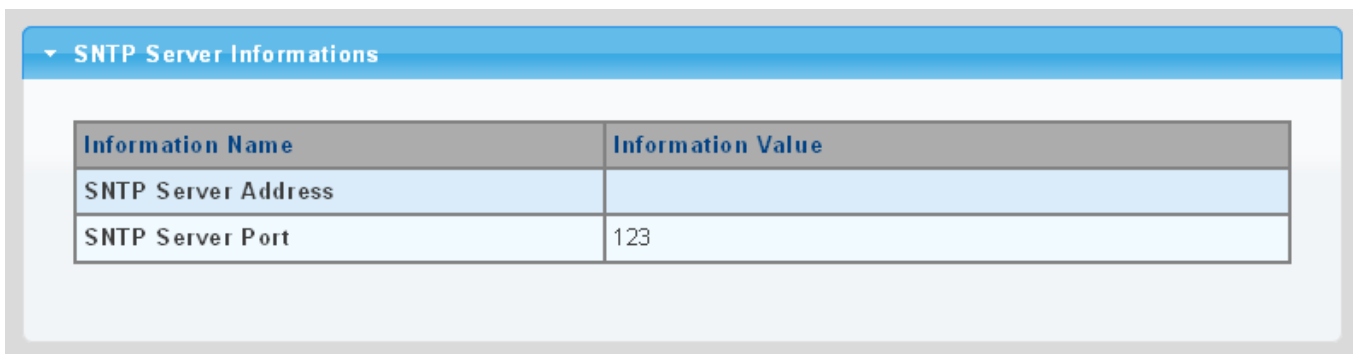

The screenshot shows a page titled "SNTP Server Information". It contains a table with two columns: "Information Name" and "Information Value". The table lists "SNTP Server Address" and "SNTP Server Port" with a value of "123".

Figure 4-2-11 SNTP Server Information Page Screenshot

The page includes the following fields:

Object	Description
• SNTP Server Address	Displays the current SNTP server address
• Server Port	Displays the current SNTP server port

## 4.2.6 Log Management

The Industrial Managed Switch log management is provided here. The local logs allow you to configure and limit system messages that are logged to flash or RAM memory. The default is for event levels 0 to 3 to be logged to flash and levels 0 to 6 to be logged to RAM. The following table lists the event levels of the Industrial Managed Switch:

Level	Severity Name	Description
7	<b>Debug</b>	Debugging messages
6	<b>Informational</b>	Informational messages only
5	<b>Notice</b>	Normal but significant condition, such as cold start
4	<b>Warning</b>	Warning conditions (e.g., return false, unexpected return)
3	<b>Error</b>	Error conditions (e.g., invalid input, default used)
2	<b>Critical</b>	Critical conditions (e.g., memory allocation, or free memory error - resource exhausted)
1	<b>Alert</b>	Immediate action needed
0	<b>Emergency</b>	System unusable

### 4.2.6.1 Local Log

The switch system local log information is provided here. The local Log screens in [Figure 4-2-12](#) & [Figure 4-2-13](#) appear.

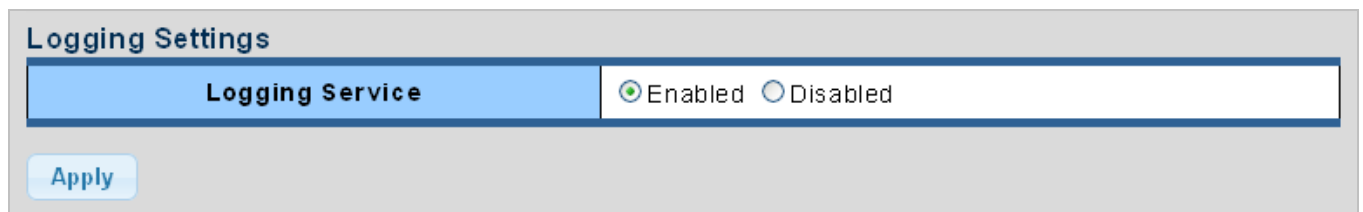

Figure 4-2-12 Logging Settings Page Screenshot

The page includes the following fields:

Object	Description
<ul style="list-style-type: none"> <li>• <b>Logging Service</b></li> </ul>	<p><b>Enabled:</b> Enable logging service operation.</p> <p><b>Disabled:</b> Disable logging service operation.</p>

#### Buttons

: Click to apply changes.

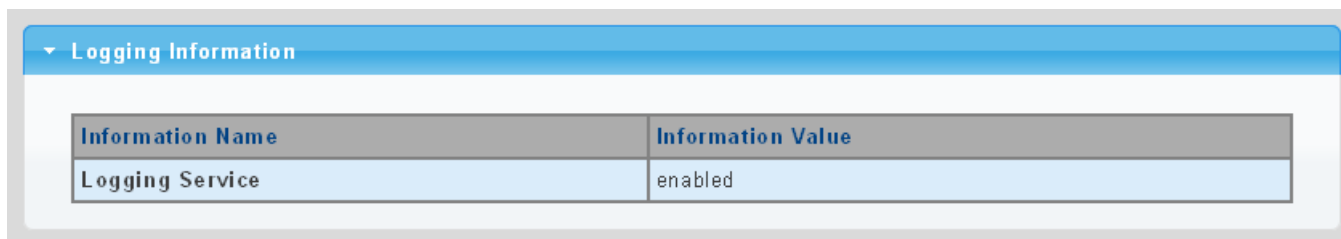

Figure 4-2-13 Logging Information Page Screenshot

The page includes the following fields:

Object	Description
<ul style="list-style-type: none"> <li>Logging Service</li> </ul>	Display the current logging service status

### 4.2.6.2 Local Log

The switch system local log information is provided here. The local Log screens in [Figure 4-2-14](#) & [Figure 4-2-15](#) appear.

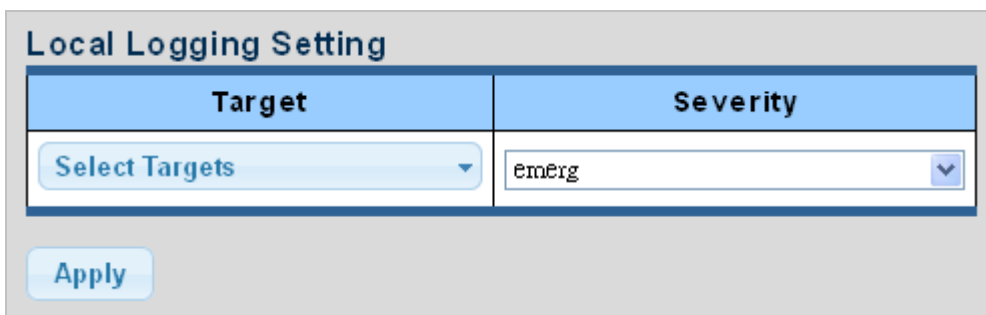



Figure 4-2-14 Local Log Target Setting Page Screenshot

The page includes the following fields:

Object	Description
<ul style="list-style-type: none"> <li>Target</li> </ul>	<p>The target of the local log entry. The following target types are supported:</p> <ul style="list-style-type: none"> <li><b>Buffered:</b> Target the buffer of the local log.</li> <li><b>File:</b> Target the file of the local log.</li> </ul>
<ul style="list-style-type: none"> <li>Severity</li> </ul>	<p>The severity of the local log entry. The following severity types are supported:</p> <ul style="list-style-type: none"> <li><b>emerg:</b> Emergency level of the system unstable for local log.</li> <li><b>alert:</b> Alert level of the immediate action needed for local log.</li> <li><b>crit:</b> Critical level of the critical conditions for local log.</li> <li><b>error:</b> Error level of the error conditions for local log.</li> <li><b>warning:</b> Warning level of the warning conditions for local log.</li> <li><b>notice:</b> Notice level of the normal but significant conditions for local log.</li> <li><b>info:</b> Informational level of the informational messages for local log.</li> <li><b>debug:</b> Debug level of the debugging messages for local log.</li> </ul>

**Buttons**

: Click to apply changes.

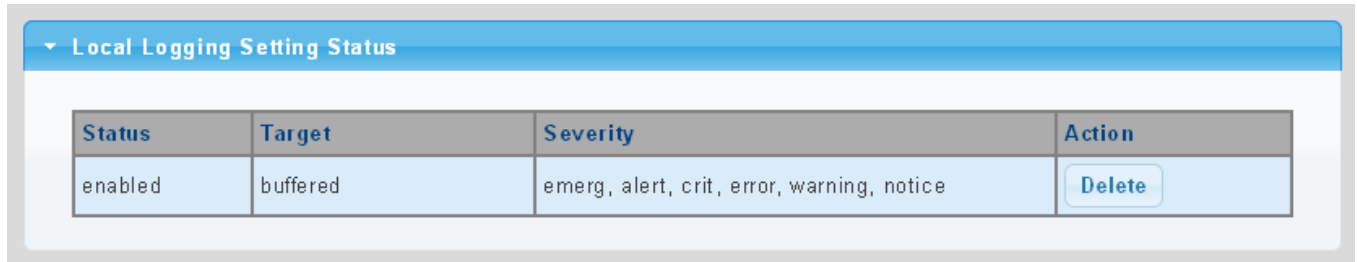

**Figure 4-2-15** Local Log Setting Status Page Screenshot

The page includes the following fields:

Object	Description
• <b>Status</b>	Displays the current local log state
• <b>Target</b>	Displays the current local log target
• <b>Severity</b>	Displays the current local log severity
• <b>Action</b>	 : Delete the current status

**4.2.6.3 Remote Syslog**

Configure remote syslog on this page. The Remote Syslog page allows you to configure the logging of messages that are sent to syslog servers or other management stations. You can also limit the event messages sent to only those messages below a specified level.

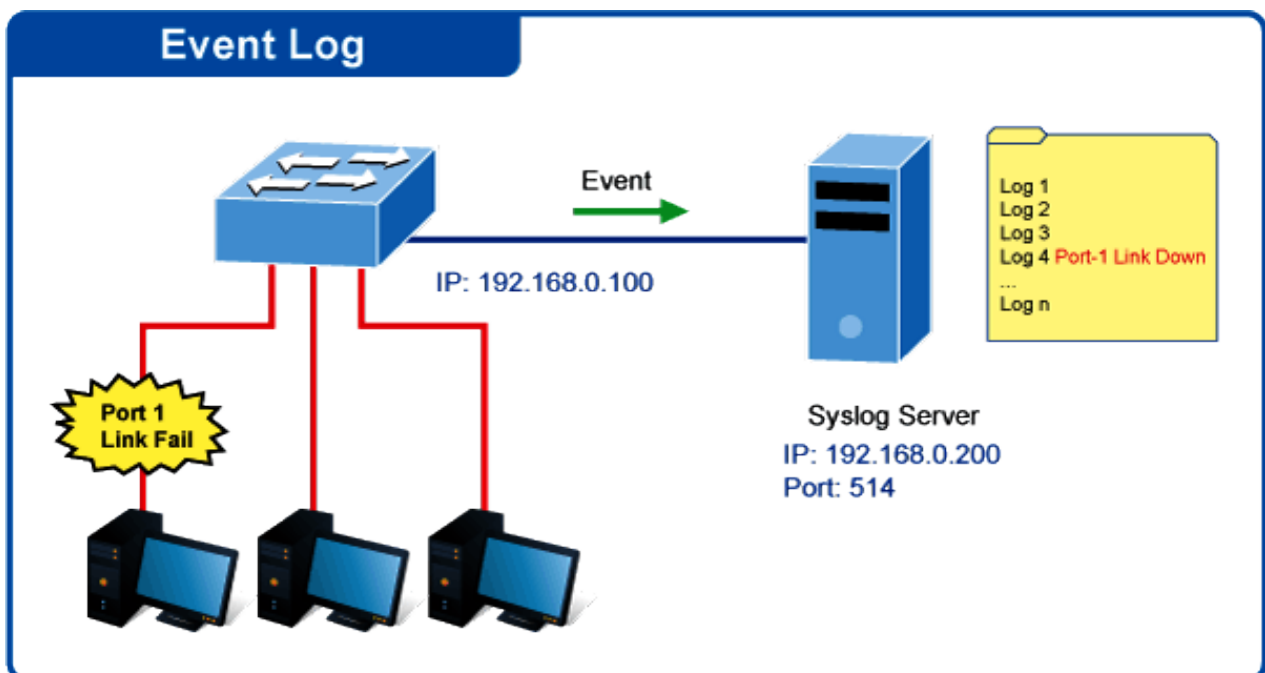

The Remote Syslog screens in [Figure 4-2-16](#) & [Figure 4-2-17](#) appear.

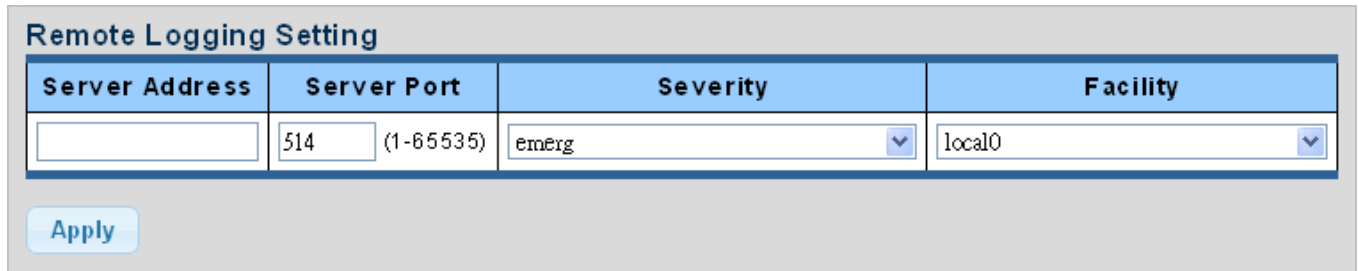

Server Address	Server Port	Severity	Facility
<input type="text"/>	514 (1-65535)	emerg	local0

Apply

**Figure 4-2-16** Remote Log Target Page Screenshot

The page includes the following fields:

Object	Description
• <b>Server Address</b>	Provides the remote syslog IP address of this switch.
• <b>Server Port</b>	Provides the port number of remote syslog server. Default Port no.: <b>514</b>
• <b>Severity</b>	The severity of the local log entry. The following severity types are supported: <ul style="list-style-type: none"> <li>■ <b>emerg</b>: Emergency level of the system unstable for local log.</li> <li>■ <b>alert</b>: Alert level of the immediate action needed for local log.</li> <li>■ <b>crit</b>: Critical level of the critical conditions for local log.</li> <li>■ <b>error</b>: Error level of the error conditions for local log.</li> <li>■ <b>warning</b>: Warning level of the warning conditions for local log.</li> <li>■ <b>notice</b>: Notice level of the normal but significant conditions for local log.</li> <li>■ <b>info</b>: Informational level of the informational messages for local log.</li> <li>■ <b>debug</b>: Debug level of the debugging messages for local log.</li> </ul>
• <b>Facility</b>	<b>Local0~7</b> : local user 0~7

**Buttons**

: Click to apply changes.



Remote Logging Setting Status				
Status	Server Info	Severity	Facility	Action

**Figure 4-2-17** Remote Log Setting Status Page Screenshot

The page includes the following fields:

Object	Description
• <b>Status</b>	Displays the current remote syslog state
• <b>Server Info</b>	Displays the current remote syslog server information

• Severity	Displays the current remote syslog severity
• Facility	Displays the current remote syslog facility
• Action	<b>Delete</b> : Delete the remote server entry

#### 4.2.6.4 Log Message

The switch log view is provided here. The Log View screens in [Figure 4-2-18](#), [Figure 4-2-19](#) & [Figure 4-2-20](#) appear.

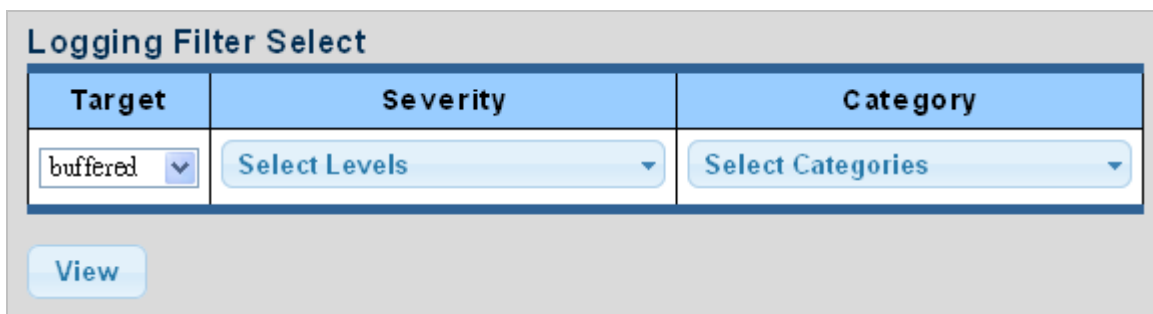

Figure 4-2-18 Log Information Select Page Screenshot

The page includes the following fields:

Object	Description
• Target	The target of the log view entry. The following target types are supported: <ul style="list-style-type: none"> <li>■ <b>Buffered</b>: Target the buffered of the log view.</li> <li>■ <b>File</b>: Target the file of the log view.</li> </ul>
• Severity	The severity of the log view entry. The following severity types are supported: <ul style="list-style-type: none"> <li>■ <b>emerg</b>: Emergency level of the system unstable for log view.</li> <li>■ <b>alert</b>: Alert level of the immediate action needed for log view.</li> <li>■ <b>crit</b>: Critical level of the critical conditions for log view.</li> <li>■ <b>error</b>: Error level of the error conditions for log view.</li> <li>■ <b>warning</b>: Warning level of the warning conditions for log view.</li> <li>■ <b>notice</b>: Notice level of the normal but significant conditions for log view.</li> <li>■ <b>info</b>: Informational level of the informational messages for log view.</li> <li>■ <b>debug</b>: Debug level of the debugging messages for log view.</li> </ul>
• Category	The category of the log view includes: AAA, ACL, CABLE_DIAG, DAI, DHCP_SNOOPING, Dot1X, GVRP, IGMP_SNOOPING, IPSG, L2, LLDP, Mirror, MLD_SNOOPING, Platform, PM, Port, PORT_SECURITY, QoS, Rate, SNMP and STP

#### Buttons

**View**: Click to view log.

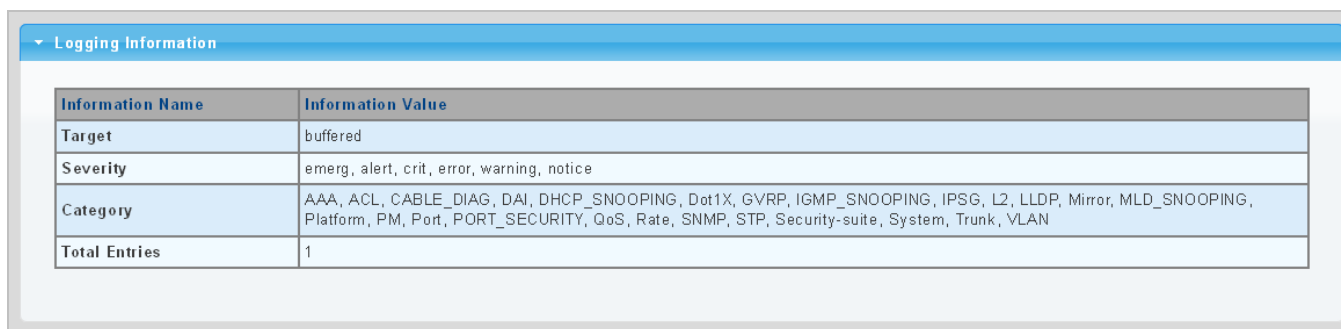

Figure 4-2-19 Logging Information Page Screenshot

The page includes the following fields:

Object	Description
• Target	Displays the current log target
• Severity	Displays the current log severity
• Category	Displays the current log category
• Total Entries	Displays the current log entries

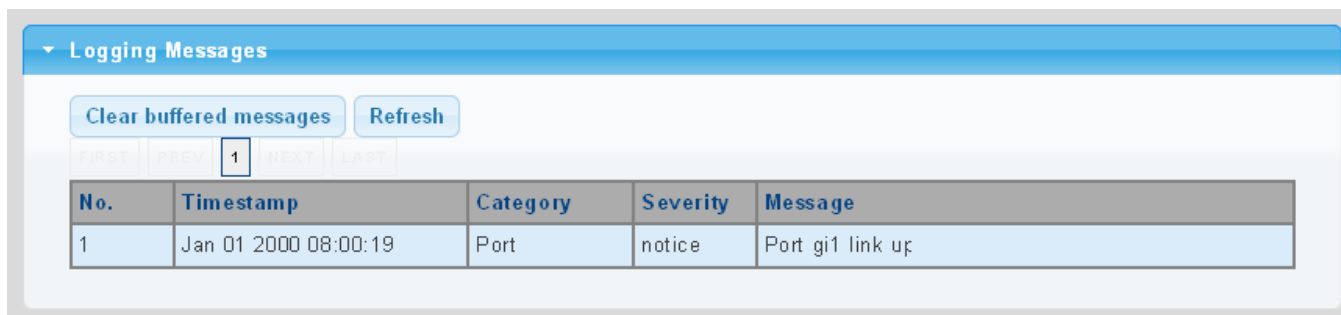

Figure 4-2-20 Logging Messages Page Screenshot

The page includes the following fields:

Object	Description
• No.	This is the number for logs
• Timestamp	Displays the time of log
• Category	Displays the category type
• Severity	Displays the severity type
• Message	Displays the log message

**Buttons**

**Clear** : Click to clear the log.

**Refresh** : Click to refresh the log.



## 4.2.7 SNMP Management

### 4.2.7.1 SNMP Overview

The **Simple Network Management Protocol (SNMP)** is an application layer protocol that facilitates the exchange of management information between network devices. It is part of the **Transmission Control Protocol/Internet Protocol (TCP/IP)** protocol suite. SNMP enables network administrators to manage network performance, find and solve network problems, and plan for network growth.

An SNMP-managed network consists of three key components: Network management stations (NMS's), SNMP agents, Management information base (MIB) and network-management protocol:

- **Network management stations (NMS's):** Sometimes called consoles, these devices execute management applications that monitor and control network elements. Physically, NMS's are usually engineering workstation-caliber computers with fast CPUs, megapixel color displays, substantial memory, and abundant disk space. At least one NMS must be present in each managed environment.
- **Agents :** Agents are software modules that reside in network elements. They collect and store management information such as the number of error packets received by a network element.
- **Management information base (MIB) :** A MIB is a collection of managed objects residing in a virtual information store. Collections of related managed objects are defined in specific MIB modules.
- **Network-management protocol :** A management protocol is used to convey management information between agents and NMS's. SNMP is the Internet community's de facto standard management protocol.

### SNMP Operations

SNMP itself is a simple request/response protocol. NMS's can send multiple requests without receiving a response.

- **Get --** Allows the NMS to retrieve an object instance from the agent.
- **Set --** Allows the NMS to set values for object instances within an agent.
- **Trap --** Used by the agent to asynchronously inform the NMS of some event. The SNMPv2 trap message is designed to replace the SNMPv1 trap message.

### SNMP community

An SNMP community is the group that devices and management stations running SNMP belong to. It helps define where information is sent. The community name is used to identify the group. An SNMP device or agent may belong to more than one SNMP community. It will not respond to requests from management stations that do not belong to one of its communities.

SNMP default communities are:

- **Write** = private
- **Read** = public

### 4.2.7.2 SNMP Setting

Configure SNMP setting on this page. The SNMP System global setting screens in [Figure 4-2-21](#) & [Figure 4-2-22](#) appear.



Figure 4-2-21 SNMP Global Setting Page Screenshot

The page includes the following fields:

Object	Description
<ul style="list-style-type: none"> <li>• <b>Status</b></li> </ul>	Indicates the SNMP mode operation. Possible modes are: <b>Enabled:</b> Enable SNMP mode operation. <b>Disabled:</b> Disable SNMP mode operation.

#### Buttons

: Click to apply changes.

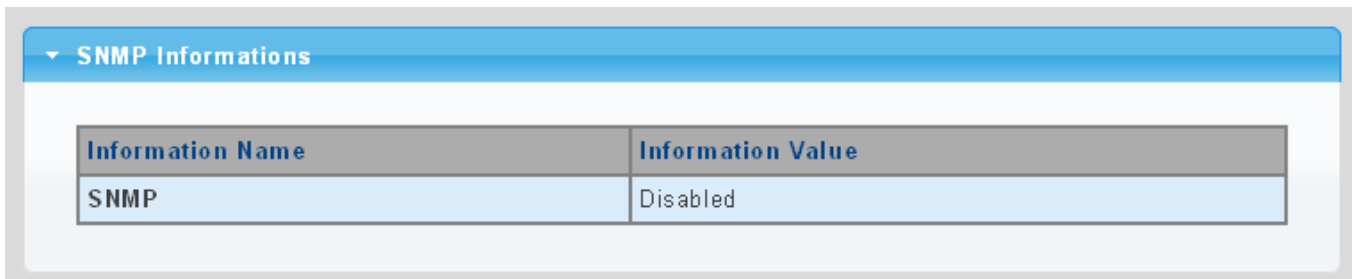

Figure 4-2-22 SNMP Information Page Screenshot

The page includes the following fields:

Object	Description
<ul style="list-style-type: none"> <li>• <b>SNMP</b></li> </ul>	Displays the current SNMP status

### 4.2.7.3 SNMP View

Configure SNMPv3 view table on this page. The entry index keys are **View Name** and **OID Subtree**. The SNMPv3 View Table Setting screens in [Figure 4-2-23](#) and [Figure 4-2-24](#) appear.

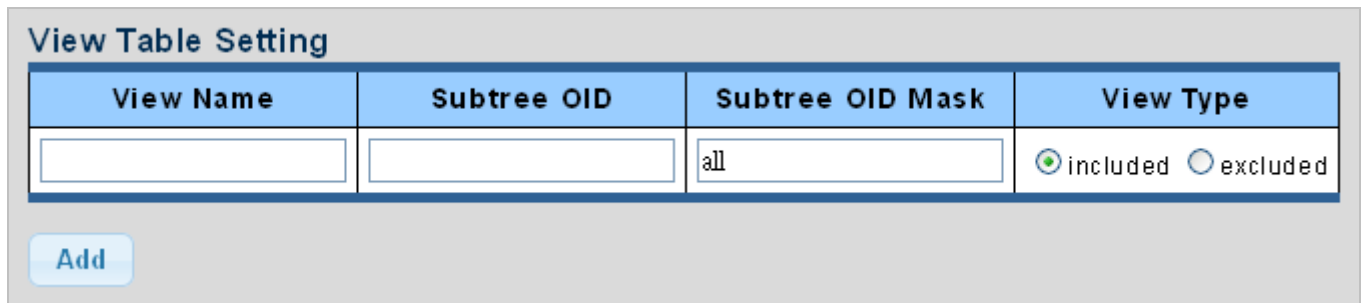

View Name	Subtree OID	Subtree OID Mask	View Type
<input type="text"/>	<input type="text"/>	all	<input checked="" type="radio"/> included <input type="radio"/> excluded

Figure 4-2-23 SNMPv3 View Table Setting Page Screenshot

The page includes the following fields:

Object	Description
<ul style="list-style-type: none"> <li><b>View Name</b></li> </ul>	A string identifying the view name that this entry should belong to. The allowed string length is 1 to 16.
<ul style="list-style-type: none"> <li><b>Subtree OID</b></li> </ul>	The OID defining the root of the subtree to add to the named view. The allowed string content is digital number or asterisk (*).
<ul style="list-style-type: none"> <li><b>Subtree OID Mask</b></li> </ul>	The bitmask identifies which positions in the specified object identifier are to be regarded as "wildcards" for the purpose of pattern-matching.
<ul style="list-style-type: none"> <li><b>View Type</b></li> </ul>	Indicates the view type that this entry should belong to. Possible view type are: <b>included</b> : An optional flag to indicate that this view subtree should be included. <b>excluded</b> : An optional flag to indicate that this view subtree should be excluded.  General, if a view entry's view type is 'excluded', it should exist another view entry in which view type is 'included' and its OID subtree oversteps the 'excluded' view entry.

#### Buttons

: Click to add a new view entry.

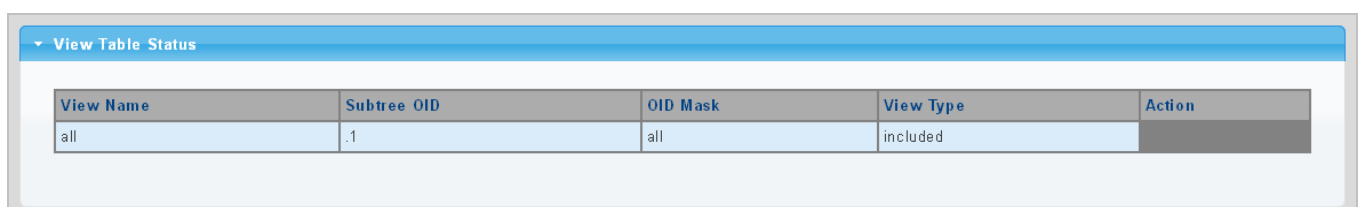

View Name	Subtree OID	OID Mask	View Type	Action
all	.1	all	included	

Figure 4-2-24 SNMP View Table Status Page Screenshot

The page includes the following fields:

Object	Description
• <b>View Name</b>	Displays the current SNMP view name
• <b>Subtree OID</b>	Displays the current SNMP subtree OID
• <b>OID Mask</b>	Displays the current SNMP OID mask
• <b>View Type</b>	Displays the current SNMP view type
• <b>Action</b>	<div style="border: 1px solid black; padding: 2px; display: inline-block;">Delete</div> : Delete the view table entry.

#### 4.2.7.4 SNMP Access Group

Configure SNMPv3 access group on this page. The entry index keys are **Group Name**, **Security Model** and **Security Level**. The SNMPv3 Access Group Setting screens in [Figure 4-2-25](#) & [Figure 4-2-26](#) appear.

**Access Group Setting**

Group Name	Security Model	Security Level	Read View Name	Write View Name	Notify View Name
<input type="text"/>	v1	noauth	all	None	None

Figure 4-2-25 SNMPv3 Access Group Setting Page Screenshot

The page includes the following fields:

Object	Description
• <b>Group Name</b>	A string identifying the group name that this entry should belong to. The allowed string length is 1 to 16.
• <b>Security Model</b>	Indicates the security model that this entry should belong to. Possible security models are: <ul style="list-style-type: none"> <li>■ <b>v1</b>: Reserved for SNMPv1.</li> <li>■ <b>v2c</b>: Reserved for SNMPv2c.</li> <li>■ <b>V3</b>: Reserved for SNMPv3 or User-based Security Model (USM)</li> </ul>
• <b>Security Level</b>	Indicates the security model that this entry should belong to. Possible security models are: <ul style="list-style-type: none"> <li>■ <b>Noauth</b>: None authentication and none privacy security levels are assigned to the group.</li> <li>■ <b>auth</b>: Authentication and none privacy.</li> <li>■ <b>priv</b>: Authentication and privacy.</li> </ul>

	Note: The Security Level applies to SNNPv3 only.
<ul style="list-style-type: none"> <li>• <b>Read View Name</b></li> </ul>	<p>Read view name is the name of the view in which you can only view the contents of the agent.</p> <p>The allowed string length is 1 to 16.</p>
<ul style="list-style-type: none"> <li>• <b>Write View Name</b></li> </ul>	<p>Write view name is the name of the view in which you enter data and configure the contents of the agent.</p> <p>The allowed string length is 1 to 16.</p>
<ul style="list-style-type: none"> <li>• <b>Notify View Name</b></li> </ul>	<p>Notify view name is the name of the view in which you specify a notify, inform, or trap.</p>

**Buttons**

**Add** : Click to add a new access entry.

**Delete** : Check to delete the entry.

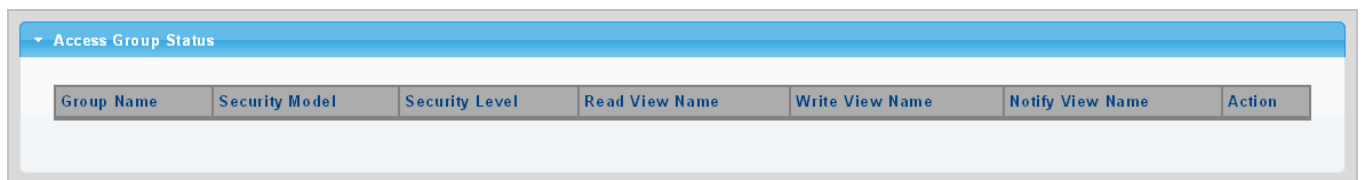

**Figure 4-2-26** SNMP View Table Status Page Screenshot

The page includes the following fields:

Object	Description
<ul style="list-style-type: none"> <li>• <b>Group Name</b></li> </ul>	Displays the current SNMP access group name
<ul style="list-style-type: none"> <li>• <b>Security Model</b></li> </ul>	Displays the current security model
<ul style="list-style-type: none"> <li>• <b>Security Level</b></li> </ul>	Displays the current security level
<ul style="list-style-type: none"> <li>• <b>Read View Name</b></li> </ul>	Displays the current read view name
<ul style="list-style-type: none"> <li>• <b>Write View Name</b></li> </ul>	Displays the current write view name
<ul style="list-style-type: none"> <li>• <b>Notify View Name</b></li> </ul>	Displays the current notify view name
<ul style="list-style-type: none"> <li>• <b>Action</b></li> </ul>	<p><b>Delete</b> : Delete the access group entry.</p>

### 4.2.7.5 SNMP Community

Configure SNMP Community on this page. The SNMP Community screens in [Figure 4-2-27](#) & [Figure 4-2-28](#) appear.

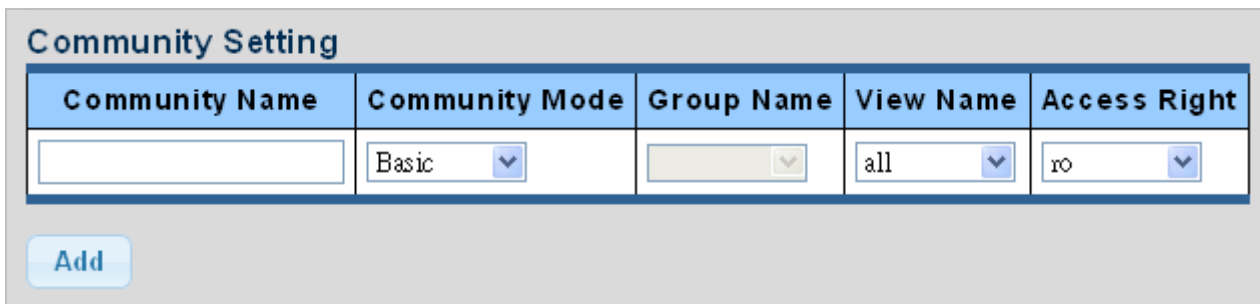

The screenshot shows a 'Community Setting' form with the following fields:

Community Name	Community Mode	Group Name	View Name	Access Right
<input type="text"/>	Basic <input type="button" value="v"/>	<input type="text"/>	all <input type="button" value="v"/>	ro <input type="button" value="v"/>

Below the table is an 'Add' button.

Figure 4-2-27 Community Setting Page Screenshot

The page includes the following fields:

Object	Description
<ul style="list-style-type: none"> <li>Community Name</li> </ul>	<p>Indicates the community read/write access string to permit access to SNMP agent.</p> <p>The allowed string length is 0 to 16.</p>
<ul style="list-style-type: none"> <li>Community Mode</li> </ul>	<p>Indicates the SNMP community supported mode. Possible versions are:</p> <ul style="list-style-type: none"> <li>■ <b>Basic</b>: Set SNMP community mode supported version 1 and 2c.</li> <li>■ <b>Advanced</b>: Set SNMP community mode supported version 3.</li> </ul>
<ul style="list-style-type: none"> <li>Group Name</li> </ul>	<p>A string identifying the group name that this entry should belong to.</p> <p>The allowed string length is 1 to 16.</p>
<ul style="list-style-type: none"> <li>View Name</li> </ul>	<p>A string identifying the view name that this entry should belong to.</p> <p>The allowed string length is 1 to 16.</p>
<ul style="list-style-type: none"> <li>Access Right</li> </ul>	<p>Indicates the SNMP community type operation. Possible types are:</p> <ul style="list-style-type: none"> <li><b>RO=Read-Only</b>: Set access string type in read-only mode.</li> <li><b>RW=Read-Write</b>: Set access string type in read-write mode.</li> </ul>

#### Buttons

: Click to apply changes.

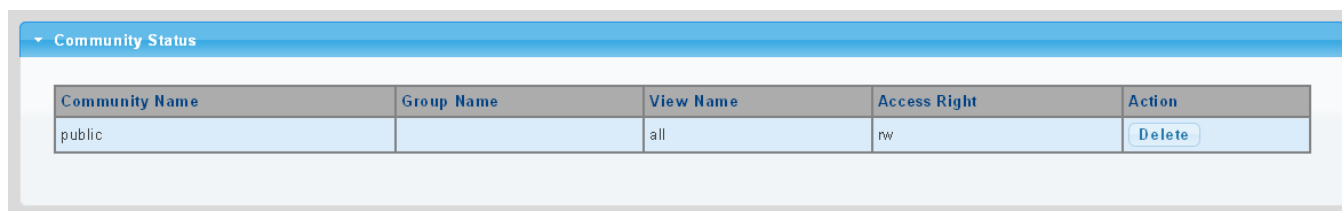

The screenshot shows a 'Community Status' table with the following data:

Community Name	Group Name	View Name	Access Right	Action
public		all	rw	<input type="button" value="Delete"/>

Figure 4-2-28 Community Status Page Screenshot

The page includes the following fields:

Object	Description
• <b>Community Name</b>	Displays the current community type
• <b>Group Name</b>	Displays the current SNMP access group's name
• <b>View Name</b>	Displays the current view name
• <b>Access Right</b>	Displays the current access type
• <b>Delete</b>	 : Delete the community entry

#### 4.2.7.6 SNMP User

Configure SNMPv3 users table on this page. Each SNMPv3 user is defined by a unique name. Users must be configured with a specific security level and assigned to a group. The SNMPv3 group restricts users to a specific read, write, and notify view. The entry index key is **User Name**. The SNMPv3 User Setting screens in [Figure 4-2-29](#) & [Figure 4-2-30](#) appear.

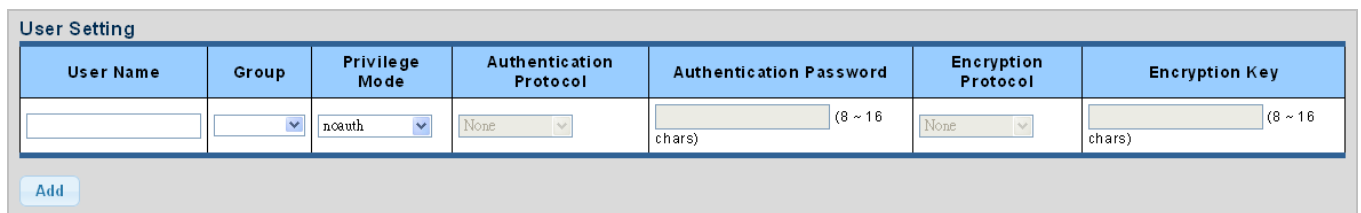

User Name	Group	Privilege Mode	Authentication Protocol	Authentication Password	Encryption Protocol	Encryption Key
<input type="text"/>	<input type="text" value=""/>	<input type="text" value="noauth"/>	<input type="text" value="None"/>	<input type="text" value=""/> (8 ~ 16 chars)	<input type="text" value="None"/>	<input type="text" value=""/> (8 ~ 16 chars)

Figure 4-2-29 SNMPv3 Users Configuration Page Screenshot

The page includes the following fields:

Object	Description
• <b>User Name</b>	A string identifying the user name that this entry should belong to. The allowed string length is 1 to 16.
• <b>Group</b>	The SNMP Access Group. A string identifying the group name that this entry should belong to.
• <b>Privilege Mode</b>	Indicates the security model that this entry should belong to. Possible security models are: <ul style="list-style-type: none"> <li>■ <b>NoAuth</b>: None authentication and none privacy.</li> <li>■ <b>Auth</b>: Authentication and none privacy.</li> <li>■ <b>Priv</b>: Authentication and privacy.</li> </ul> The value of security level cannot be modified if entry already exists. That means you must first ensure that the value is set correctly.
• <b>Authentication Protocol</b>	Indicates the authentication protocol that this entry should belong to. Possible authentication protocols are: <ul style="list-style-type: none"> <li>■ <b>None</b>: None authentication protocol.</li> </ul>

	<ul style="list-style-type: none"> <li>■ <b>MD5</b>: An optional flag to indicate that this user using MD5 authentication protocol.</li> <li>■ <b>SHA</b>: An optional flag to indicate that this user using SHA authentication protocol.</li> </ul> <p>The value of security level cannot be modified if entry already exists. That means you must first ensure that the value is set correctly.</p>
• <b>Authentication Password</b>	A string identifying the authentication pass phrase. For both MD5 and SHA authentication protocols, the allowed string length is 8 to 16.
• <b>Encryption Protocol</b>	Indicates the privacy protocol that this entry should belong to. Possible privacy protocol are: <ul style="list-style-type: none"> <li>■ <b>None</b>: None privacy protocol.</li> <li>■ <b>DES</b>: An optional flag to indicate that this user using DES authentication protocol.</li> </ul>
• <b>Encryption Key</b>	A string identifying the privacy pass phrase. The allowed string length is 8 to 16.

**Buttons**

**Add** : Click to add a new user entry.

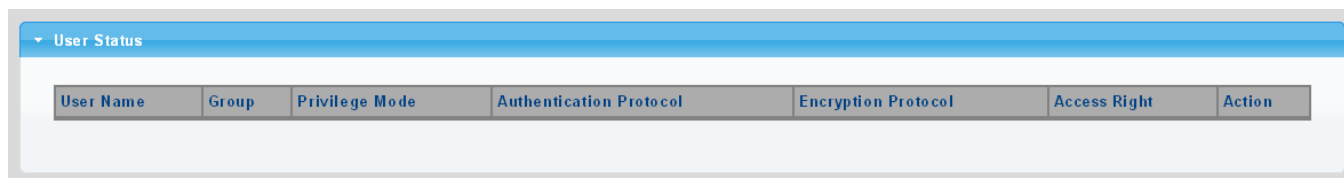

**Figure 4-2-30** SNMPv3 Users Status Page Screenshot

The page includes the following fields:

Object	Description
• <b>User Name</b>	Displays the current user name
• <b>Group</b>	Displays the current group
• <b>Privilege Mode</b>	Displays the current privilege mode
• <b>Authentication Protocol</b>	Displays the current authentication protocol
• <b>Encryption Protocol</b>	Displays the current encryption protocol
• <b>Access Right</b>	Displays the current access right
• <b>Action</b>	<b>Delete</b> : Delete the user entry



### 4.2.7.7 SNMPv1, 2 Notification Recipients

Configure SNMPv1 and 2 notification recipients on this page. The SNMPv1, 2 Notification Recipients screens in [Figure 4-2-31](#) & [Figure 4-2-32](#) appear.

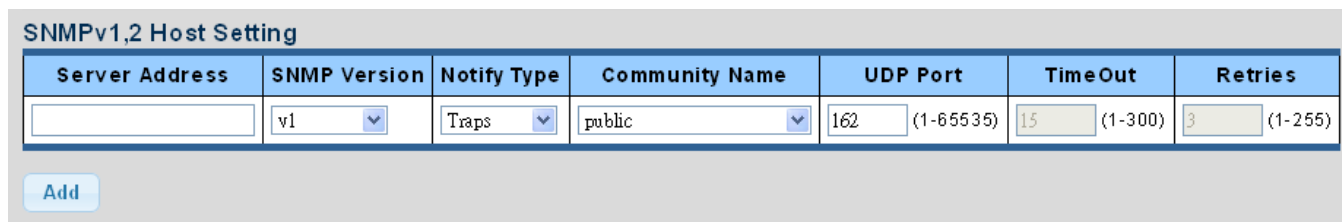

Server Address	SNMP Version	Notify Type	Community Name	UDP Port	Time Out	Retries
	v1	Traps	public	162 (1-65535)	15 (1-300)	3 (1-255)

Add

Figure 4-2-31 SNMPv1, 2 Notification Recipients Page Screenshot

The page includes the following fields:

Object	Description
• <b>Server Address</b>	Indicates the SNMP trap destination address. It allows a valid IP address in dotted decimal notation ('x.y.z.w'). It can also represent a legally valid IPv4 address. For example, '::192.1.2.34'.
• <b>SNMP Version</b>	Indicates the SNMP trap supported version. Possible versions are: <ul style="list-style-type: none"> <li>■ <b>SNMP v1</b>: Set SNMP trap supported version 1.</li> <li>■ <b>SNMP v2c</b>: Set SNMP trap supported version 2c.</li> </ul>
• <b>Notify Type</b>	Set the notify type in traps or informs.
• <b>Community Name</b>	Indicates the community access string when send SNMP trap packet.
• <b>UDP Port</b>	Indicates the SNMP trap destination port. SNMP Agent will send SNMP message via this port, the port range is 1~65535.
• <b>Time Out</b>	Indicates the SNMP trap inform timeout. The allowed range is <b>1</b> to <b>300</b> .
• <b>Retries</b>	Indicates the SNMP trap inform retry times. The allowed range is <b>1</b> to <b>255</b> .

#### Buttons

**Add**: Click to add a new SNMPv1, 2 host entry.

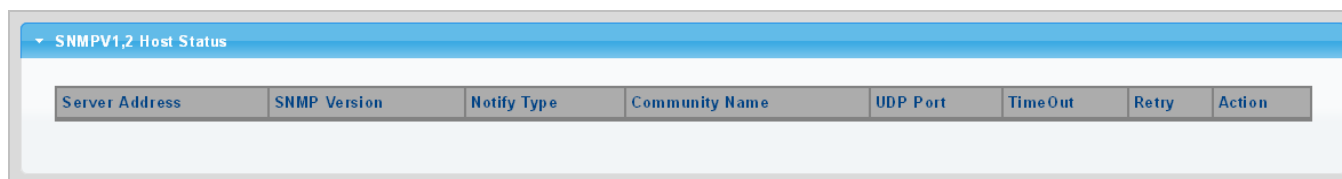

Server Address	SNMP Version	Notify Type	Community Name	UDP Port	TimeOut	Retry	Action
----------------	--------------	-------------	----------------	----------	---------	-------	--------

Figure 4-2-32 SNMPv1, 2 Host Status Page Screenshot

The page includes the following fields:

Object	Description
• <b>Server Address</b>	Displays the current server address
• <b>SNMP Version</b>	Displays the current SNMP version
• <b>Notify Type</b>	Displays the current notify type
• <b>Community Name</b>	Displays the current community name
• <b>UDP Port</b>	Displays the current UDP port
• <b>Time Out</b>	Displays the current time out
• <b>Retries</b>	Displays the current retry times
• <b>Action</b>	<div style="border: 1px solid black; padding: 2px; display: inline-block;">Delete</div> : Delete the SNMPv1, 2 host entry.

#### 4.2.7.8 SNMPv3 Notification Recipients

Configure SNMPv3 notification recipients on this page. The SNMPv1, 2 Notification Recipients screens in [Figure 4-2-33](#) & [Figure 4-2-34](#) appear.

**SNMPv3 Host Setting**

Server Address	Notify Type	User Name	UDP Port	TimeOut	Retries
<input type="text"/>	Traps <input type="button" value="v"/>	<input type="text"/> <input type="button" value="v"/>	162 (1-65535)	15 (1-300)	3 (1-255)

Figure 4-2-33 SNMPv3 Notification Recipients Page Screenshot

The page includes the following fields:

Object	Description
• <b>Server Address</b>	Indicates the SNMP trap destination address. It allows a valid IP address in dotted decimal notation ('x.y.z.w'). It can also represent a legally valid IPv4 address. For example, '::192.1.2.34'.
• <b>Notify Type</b>	Set the notify type in traps or informs.
• <b>User Name</b>	Indicates the user string when send SNMP trap packet.
• <b>UDP Port</b>	Indicates the SNMP trap destination port. SNMP Agent will send SNMP message via this port, the port range is 1~65535.
• <b>Time Out</b>	Indicates the SNMP trap inform timeout. The allowed range is <b>1</b> to <b>300</b> .
• <b>Retries</b>	Indicates the SNMP trap inform retry times. The allowed range is <b>1</b> to <b>255</b> .

**Buttons**

**Add** : Click to add a new SNMPv3 host entry.

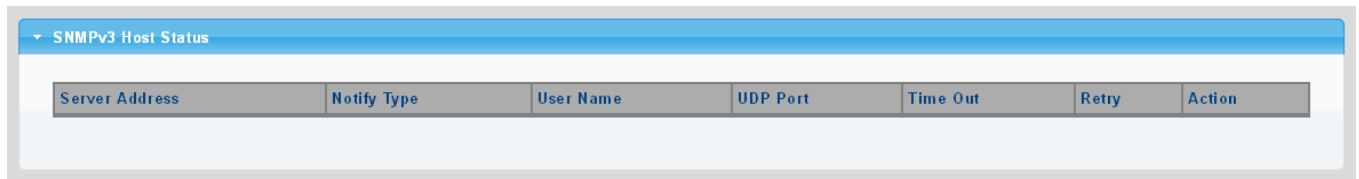

**Figure 4-2-34** SNMPv3 Host Status Page Screenshot

The page includes the following fields:

Object	Description
• <b>Server Address</b>	Displays the current server address
• <b>Notify Type</b>	Displays the current notify type
• <b>User Name</b>	Displays the current user name
• <b>UDP Port</b>	Displays the current UDP port
• <b>Time Out</b>	Displays the current time out
• <b>Retries</b>	Displays the current retry times
• <b>Action</b>	<b>Delete</b> : Delete the SNMPv3 host entry

### 4.2.7.9 SNMP Engine ID

Configure SNMPv3 Engine ID on this page. The entry index key is Engine ID. The remote engine ID is used to compute the security digest for authenticating and encrypting packets sent to a user on the remote host. The SNMPv3 Engine ID Setting screens in [Figure 4-2-35](#) & [Figure 4-2-36](#) appear.

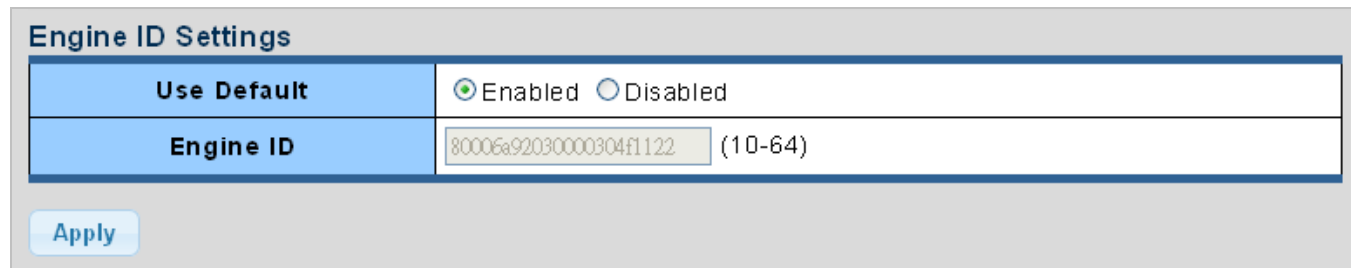

Figure 4-2-35 SNMPv3 Engine ID Setting Page Screenshot

The page includes the following fields:

Object	Description
<ul style="list-style-type: none"> <li>Engine ID</li> </ul>	An octet string identifying the engine ID that this entry should belong to. The string must contain an even number between 10 and 64 hexadecimal digits, but all-zeros and all-F's are not allowed.

#### Buttons

: Click to apply changes.

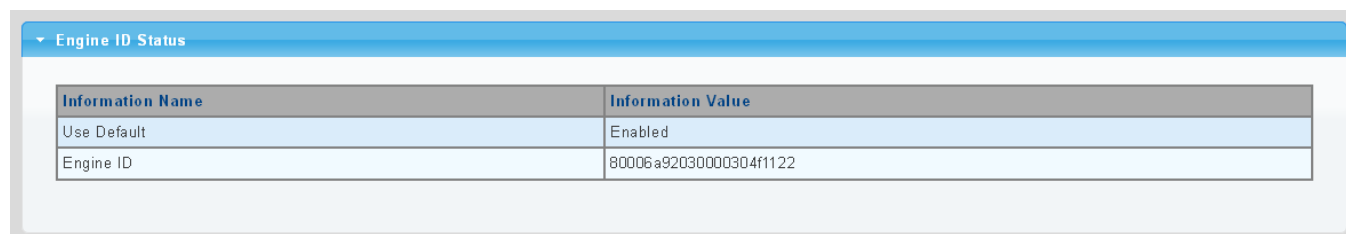

Figure 4-2-36 SNMPv3 Engine ID Status Page Screenshot

The page includes the following fields:

Object	Description
<ul style="list-style-type: none"> <li>User Default</li> </ul>	Displays the current status
<ul style="list-style-type: none"> <li>Engine ID</li> </ul>	Displays the current engine ID

### 4.2.7.10 SNMP Remote Engine ID

Configure SNMPv3 remote Engine ID on this page. The SNMPv3 Remote Engine ID Setting screens in [Figure 4-2-37](#) & [Figure 4-2-38](#) appear.

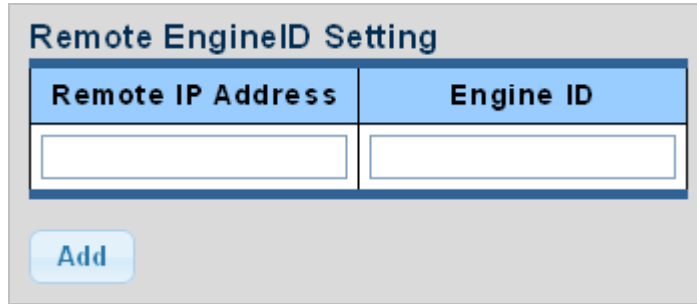

Figure 4-2-37 SNMPv3 Remote Engine ID Setting Page Screenshot

The page includes the following fields:

Object	Description
<ul style="list-style-type: none"> <li>Remote IP Address</li> </ul>	Indicates the SNMP remote engine ID address. It allows a valid IP address in dotted decimal notation ('x.y.z.w').
<ul style="list-style-type: none"> <li>Engine ID</li> </ul>	An octet string identifying the engine ID that this entry should belong to.

#### Buttons

: Click to apply changes.

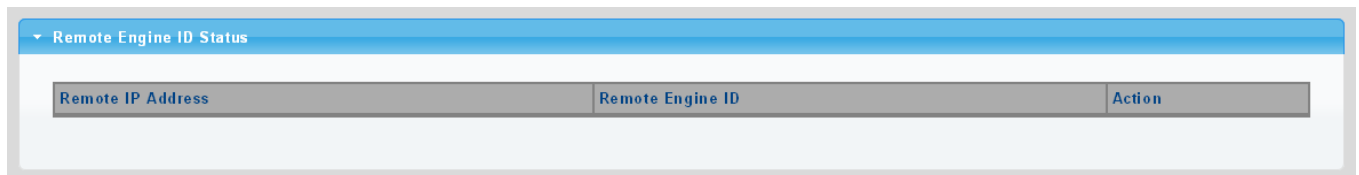



Figure 4-2-38 SNMPv3 Remote Engine ID Status Page Screenshot

The page includes the following fields:

Object	Description
<ul style="list-style-type: none"> <li>Remote IP Address</li> </ul>	Displays the current remote IP address
<ul style="list-style-type: none"> <li>Engine ID</li> </ul>	Displays the current engine ID
<ul style="list-style-type: none"> <li>Action</li> </ul>	 : Delete the remote IP address entry

## 4.2.8 Fault Alarm Configuration

This Page facilitates a fault alarm controlling the switch. The Fault Alarm Control Configuration screen in [Figure 4-2-39](#) appears.

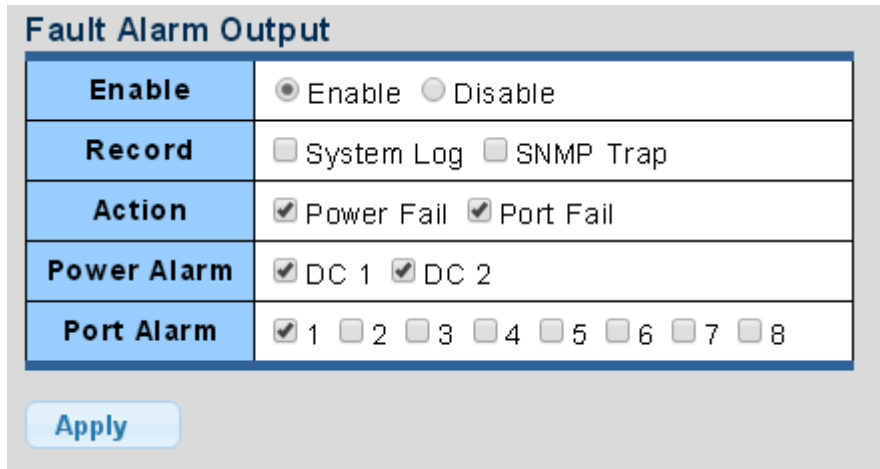

Fault Alarm Output	
<b>Enable</b>	<input checked="" type="radio"/> Enable <input type="radio"/> Disable
<b>Record</b>	<input type="checkbox"/> System Log <input type="checkbox"/> SNMP Trap
<b>Action</b>	<input checked="" type="checkbox"/> Power Fail <input checked="" type="checkbox"/> Port Fail
<b>Power Alarm</b>	<input checked="" type="checkbox"/> DC 1 <input checked="" type="checkbox"/> DC 2
<b>Port Alarm</b>	<input checked="" type="checkbox"/> 1 <input type="checkbox"/> 2 <input type="checkbox"/> 3 <input type="checkbox"/> 4 <input type="checkbox"/> 5 <input type="checkbox"/> 6 <input type="checkbox"/> 7 <input type="checkbox"/> 8

**Figure 4-2-39:** Fault Alarm Control Configuration Page Screenshot

The page includes the following fields:

Object	Description
• <b>Enable</b>	Controls whether Fault Alarm is enabled or disabled on this switch.
• <b>Record</b>	Controls whether Record is sending System log or SNMP Trap or both.
• <b>Action</b>	Controls whether Port Fail or Power Fail or both for fault detecting.
• <b>Power Alarm</b>	Controls whether DC1 or DC2 or both for fault detecting.
• <b>Port Alarm</b>	Controls which Ports or all for fault detecting.

### Buttons

: Click to apply changes.

## 4.3 Port Management

Use the Port Menu to display or configure the Industrial Managed Switch's ports. This section has the following items:

- **Port Configuration**                      Configures port configuration settings
- **Port Counters**                              Lists Ethernet and RMON port statistics
- **Bandwidth Utilization**                      Displays current bandwidth utilization
- **Port Mirroring**                              Sets the source and target ports for mirroring
- **Jumbo Frame**                                 Sets the jumbo frame on the switch
- **Port Error Disable Configuration**                      Configures port error disable settings
- **Port Error Disabled Status**                      Disables port error status
- **Protected Ports**                              Configures protected ports settings
- **EEE**    Configures EEE settings
- **SFP Module Information**                      Displays SFP module information.

### 4.3.1 Port Configuration

This page displays current port configurations and status. Ports can also be configured here. The table has one row for each port on the selected switch in a number of columns, which are:

The Port Configuration screens in [Figure 4-3-1](#) & [Figure 4-3-2](#) appear.

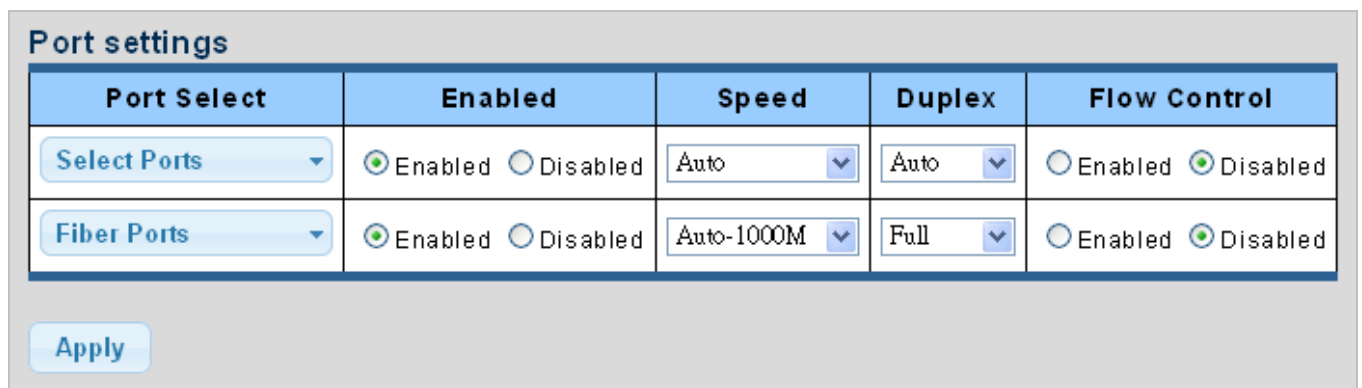

Port Select	Enabled	Speed	Duplex	Flow Control
Select Ports	<input checked="" type="radio"/> Enabled <input type="radio"/> Disabled	Auto	Auto	<input type="radio"/> Enabled <input checked="" type="radio"/> Disabled
Fiber Ports	<input checked="" type="radio"/> Enabled <input type="radio"/> Disabled	Auto-1000M	Full	<input type="radio"/> Enabled <input checked="" type="radio"/> Disabled

Apply

Figure 4-3-1 Port Settings Page Screenshot

The page includes the following fields:

Object	Description
• <b>Port Select</b>	Select port number for this drop down list.
• <b>Enabled</b>	Indicates the port state operation. Possible state are: <b>Enabled</b> - Start up the port manually. <b>Disabled</b> – Shut down the port manually.
• <b>Speed</b>	Select any available link speed for the given switch port. Draw the menu bar to



	<p>select the mode.</p> <ul style="list-style-type: none"> <li>■ <b>Auto</b> - Setup Auto negotiation.</li> <li>■ <b>Auto-10M</b> - Setup 10M Auto negotiation.</li> <li>■ <b>Auto-100M</b> - Setup 100M Auto negotiation.</li> <li>■ <b>Auto-1000M</b> - Setup 1000M Auto negotiation.</li> <li>■ <b>Auto-10/100M</b> - Setup 10/100M Auto negotiation.</li> <li>■ <b>10M</b> - Setup 10M Force mode.</li> <li>■ <b>100M</b> - Setup 100M Force mode.</li> <li>■ <b>1000M</b> - Setup 1000M Force mode.</li> </ul>
<ul style="list-style-type: none"> <li>• <b>Duplex</b></li> </ul>	<p>Select any available link duplex for the given switch port. Draw the menu bar to select the mode.</p> <ul style="list-style-type: none"> <li>■ <b>Auto</b> - Setup Auto negotiation.</li> <li>■ <b>Full</b> - Force sets Full-Duplex mode.</li> <li>■ <b>Half</b> - Force sets Half-Duplex mode.</li> </ul>
<ul style="list-style-type: none"> <li>• <b>Flow Control</b></li> </ul>	<p>When Auto Speed is selected for a port, this section indicates the flow control capability that is advertised to the link partner. When a fixed-speed setting is selected, that is what is used. Current Rx column indicates whether pause frames on the port are obeyed. Current Tx column indicates whether pause frames on the port are transmitted. The Rx and Tx settings are determined by the result of the last Auto-Negotiation. Check the configured column to use flow control. This setting is related to the setting for Configured Link Speed.</p>

**Buttons**



: Click to apply changes.

Port Status							
Port	Description	Enable State	Link Status	Speed	Duplex	FlowCtrl Config	FlowCtrl Status
GE1	<a href="#">Edit</a>	Enabled	UP	A-1000M	A-Full	Disabled	Disabled
GE2	<a href="#">Edit</a>	Enabled	DOWN	Auto	Auto	Disabled	Disabled
GE3	<a href="#">Edit</a>	Enabled	DOWN	Auto	Auto	Disabled	Disabled
GE4	<a href="#">Edit</a>	Enabled	DOWN	Auto	Auto	Disabled	Disabled
GE5	<a href="#">Edit</a>	Enabled	DOWN	Auto	Auto	Disabled	Disabled
GE6	<a href="#">Edit</a>	Enabled	DOWN	Auto	Auto	Disabled	Disabled
GE7	<a href="#">Edit</a>	Enabled	DOWN	Auto	Auto	Disabled	Disabled
GE8	<a href="#">Edit</a>	Enabled	DOWN	Auto	Auto	Disabled	Disabled
GE9	<a href="#">Edit</a>	Enabled	DOWN	Auto	Auto	Disabled	Disabled
GE10	<a href="#">Edit</a>	Enabled	DOWN	Auto	Auto	Disabled	Disabled

Figure 4-3-2 Port Status Page Screenshot

The page includes the following fields:

Object	Description
• Port	This is the logical port number for this row
• Description	Click  to indicate the port name
• Enable State	Display the current port state
• Link Status	Display the current link status
• Speed	Display the current speed status of the port
• Duplex	Display the current duplex status of the port
• Flow Control Configuration	Display the current flow control configuration of the port
• Flow Control Status	Display the current flow control status of the port

### 4.3.2 Port Counters

This page provides an overview of traffic and trunk statistics for all switch ports. The Port Statistics screens in [Figure 4-3-3](#), [Figure 4-3-4](#), [Figure 4-3-5](#) & [Figure 4-3-6](#) appear.

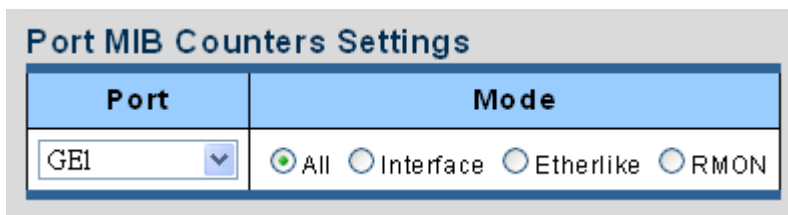

Figure 4-3-3 Port MIB Counters Page Screenshot

The page includes the following fields:

Object	Description
• Port	Select port number from this drop-down list.
• Mode	Select port counters mode. Option: <ul style="list-style-type: none"> <li>• All</li> <li>• Interface</li> <li>• Ether-link</li> <li>• RMON</li> </ul>

Interface Counters	Counters Value
Received Octets	0
Received Unicast Packets	0
Received Unknown Unicast Packets	0
Received Discards Packets	0
Transmit Octets	0
Transmit Unicast Packets	0
Transmit Unknown Unicast Packets	0
Transmit Discards Packets	0
Received Multicast Packets	0
Received Broadcast Packets	0
Transmit Multicast Packets	0
Transmit Broadcast Packets	0

Figure 4-3-4 Interface Counters Page Screenshot

Object	Description
• <b>Received Octets</b>	The total number of octets received on the interface, including framing characters.
• <b>Received Unicast Packets</b>	The number of subnetwork-unicast packets delivered to a higher-layer protocol.
• <b>Received Unknown Unicast Packets</b>	The number of packets received via the interface which is discarded because of an unknown or unsupported protocol.
• <b>Received Discards Packets</b>	The number of inbound packets which were chosen to be discarded even though no errors had been detected to prevent their being deliverable to a higher-layer protocol. One possible reason for discarding such a packet could be to free up buffer space.
• <b>Transmit Octets</b>	The total number of octets transmitted out of the interface, including framing characters.
• <b>Transmit Unicast Packets</b>	The total number of packets that higher-level protocols requested is transmitted to a subnetwork-unicast address, including those that were discarded or not sent.
• <b>Transmit Unknown Unicast Packets</b>	The total number of packets that higher-level protocols requested is transmitted to a subnetwork-unicast address, including those that were discarded or not sent.
• <b>Transmit Discards Packets</b>	The number of inbound packets which is chosen to be discarded even though no errors have been detected to prevent from being delivered to a higher-layer protocol. One possible reason for discarding such a packet could be to free up buffer space.
• <b>Received Multicast Packets</b>	The number of packets, delivered by this sub-layer to a higher (sub-) layer, is addressed to a multicast address at this sub-layer.
• <b>Received Broadcast</b>	The number of packets, delivered by this sub-layer to a higher (sub-) layer,

<b>Packets</b>	addressed to a broadcast address at this sub-layer.
• <b>Transmit Multicast Packets</b>	The total number of packets that higher-level protocols requested is transmitted and is addressed to a multicast address at this sub-layer, including those that were discarded or not sent.
• <b>Transmit Broadcast Packets</b>	The total number of packets that higher-level protocols requested is transmitted, and addressed to a broadcast address at this sub-layer, including those that were discarded or not sent.

Ethernet-link Counters	Counters Value
Alignment Errors	0
FCS Errors	0
Single Collision Frames	0
Multiple Collision Frames	0
Deferred Transmissions	0
Late Collision	0
Excessive Collision	0
Frame Too Longs	0
Symbol Errors	0
Control In Unknow Opcodes	0
In Pause Frames	0
Out Pause Frames	0

Figure 4-3-5 Ethernet link Counters Page Screenshot

Object	Description
• <b>Alignment Errors</b>	The number of alignment errors (missynchronized data packets).
• <b>FCS Errors</b>	A count of frames received on a particular interface that are an integral number of octets in length but do not pass the FCS check. This count does not include frames received with frame-too-long or frame-too-short error.
• <b>Single Collision Frames</b>	The number of successfully transmitted frames for which transmission is inhibited by exactly one collision.
• <b>Multiple Collision Frames</b>	A count of successfully transmitted frames for which transmission is inhibited by more than one collision.
• <b>Deferred Transmissions</b>	A count of frames for which the first transmission attempt on a particular interface is delayed because the medium was busy.
• <b>Late Collision</b>	The number of times that a collision is detected later than 512 bit-times into the transmission of a packet.
• <b>Excessive Collision</b>	A count of frames for which transmission on a particular interface fails due to excessive collisions. This counter does not increase when the interface is operating in full-duplex mode.

• <b>Frame Too Long</b>	A count of frames received on a particular interface that exceeds the maximum permitted frame size.
• <b>Symbol Errors</b>	The number of received and transmitted symbol errors
• <b>Control In Unknown Opcodes</b>	The number of received control unknown opcodes
• <b>In Pause Frames</b>	The number of received pause frames
• <b>Out Pause Frames</b>	The number of transmitted pause frames

<b>RMON Counters</b>	<b>Counters Value</b>
Drop Events	0
Octets	0
Packets	0
Broadcast Packets	0
Multicast Packets	0
CRC / Alignment Errors	0
Undersize Packets	0
Oversize Packets	0
Fragments	0
Jabbers	0
Collisions	0
64 Bytes Frame	0
65-127 Byte Frames	0
128-255 Byte Frames	0
256-511 Byte Frames	0
512-1023 Byte Frames	0
1024-1518 Byte Frames	0

Figure 4-3-6 RMON Counters Page Screenshot

<b>Object</b>	<b>Description</b>
• <b>Drop Events</b>	The total number of events in which packets were dropped due to lack of resources.
• <b>Octets</b>	The total number of octets received and transmitted on the interface, including framing characters.
• <b>Packets</b>	The total number of packets received and transmitted on the interface.
• <b>Broadcast Packets</b>	The total number of good frames received that were directed to the broadcast address. Note that this does not include multicast packets.
• <b>Multicast Packets</b>	The total number of good frames received that were directed to this multicast address.

<ul style="list-style-type: none"> <li>• <b>CRC/Alignment Errors</b></li> </ul>	The number of CRC/alignment errors (FCS or alignment errors).
<ul style="list-style-type: none"> <li>• <b>Undersize Packets</b></li> </ul>	The total number of frames received that were less than 64 octets long(excluding framing bits, but including FCS octets) and were otherwise well formed.
<ul style="list-style-type: none"> <li>• <b>Oversize Packets</b></li> </ul>	The total number of frames received that were longer than 1518 octets(excluding framing bits, but including FCS octets) and were otherwise well formed.
<ul style="list-style-type: none"> <li>• <b>Fragments</b></li> </ul>	The total number of frames received that were less than 64 octets in length (excluding framing bits, but including FCS octets) and had either an FCS or alignment error.
<ul style="list-style-type: none"> <li>• <b>Jabbers</b></li> </ul>	The total number of frames received that were longer than 1518 octets (excluding framing bits, but including FCS octets), and had either an FCS or alignment error.
<ul style="list-style-type: none"> <li>• <b>Collisions</b></li> </ul>	The best estimate of the total number of collisions on this Ethernet segment.
<ul style="list-style-type: none"> <li>• <b>64 Bytes Frames</b></li> </ul>	The total number of frames (including bad packets) received and transmitted that were 64 octets in length (excluding framing bits but including FCS octets).
<ul style="list-style-type: none"> <li>• <b>65-127 Byte Frames</b></li> <li>• <b>128-255 Byte Frames</b></li> <li>• <b>256-511 Byte Frames</b></li> <li>• <b>512-1023 Byte Frames</b></li> <li>• <b>1024-1518 Byte Frames</b></li> </ul>	The total number of frames (including bad packets) received and transmitted where the number of octets falls within the specified range (excluding framing bits but including FCS octets).

### 4.3.3 Bandwidth Utilization

The **Bandwidth Utilization** page displays the percentage of the total available bandwidth being used on the ports. Bandwidth utilization statistics can be viewed using a line graph. The Bandwidth Utilization screen in [Figure 4-3-7](#) appears.

To view the port utilization, click on the **Port Management** folder and then the **Bandwidth Utilization** link:

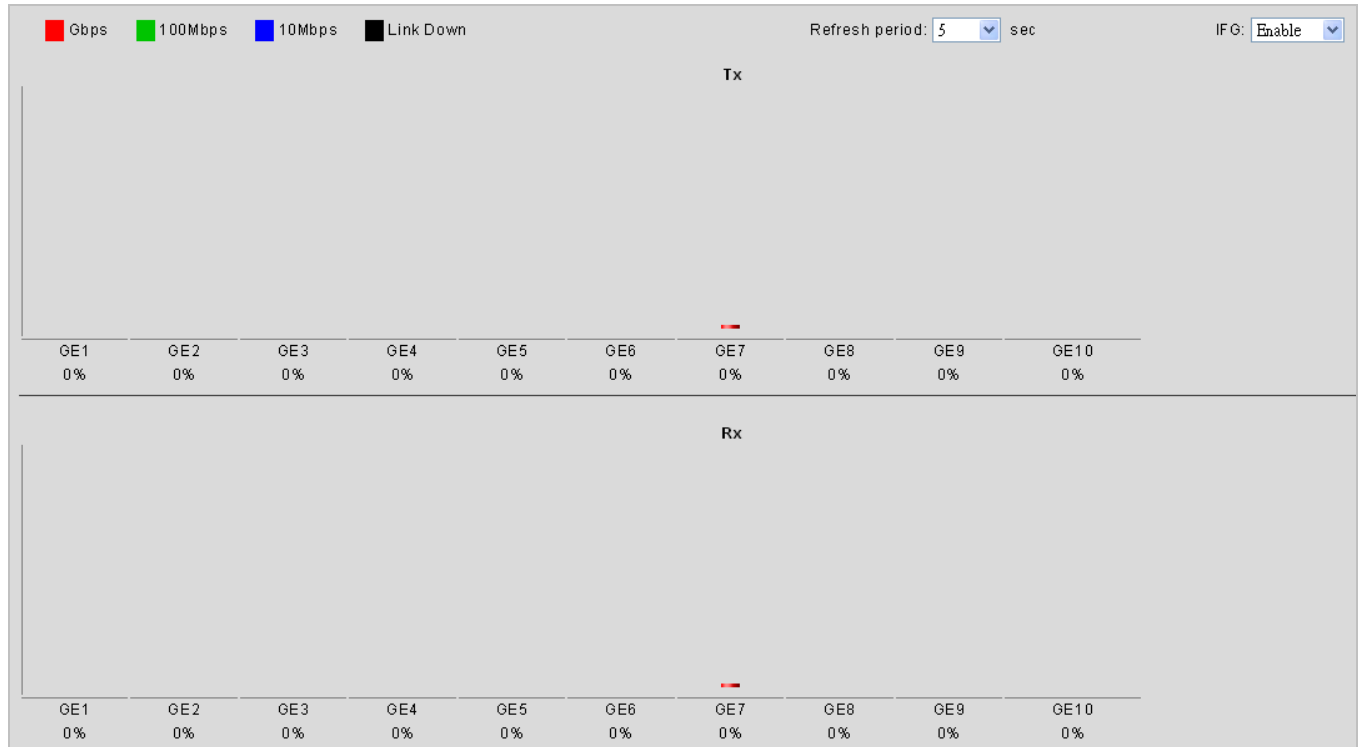

**Figure 4-3-7** Port Bandwidth Utilization Page Screenshot

The page includes the following fields:

Object	Description
<ul style="list-style-type: none"> <li><b>Refresh Period</b></li> </ul>	<p>This shows the period interval between last and next refresh.</p> <p>Options:</p> <ul style="list-style-type: none"> <li>■ 2 sec</li> <li>■ 5 sec</li> <li>■ 10 sec</li> </ul>
<ul style="list-style-type: none"> <li><b>IFG</b></li> </ul>	<p>Allows user to <b>enable</b> or <b>disable</b> this function</p>

### 4.3.4 Port Mirroring

Configure port Mirroring on this page. This function provides monitoring of network traffic that forwards a copy of each incoming or outgoing packet from one port of a network switch to another port where the packet can be studied. It enables the manager to keep close track of switch performance and alter it if necessary.

- To debug network problems, selected traffic can be copied, or mirrored, to a mirror port where a frame analyzer can be attached to analyze the frame flow.
- The Industrial Managed Switch can unobtrusively mirror traffic from any port to a monitor port. You can then attach a protocol analyzer or RMON probe to this port to perform traffic analysis and verify connection integrity.

#### Port Mirror Application

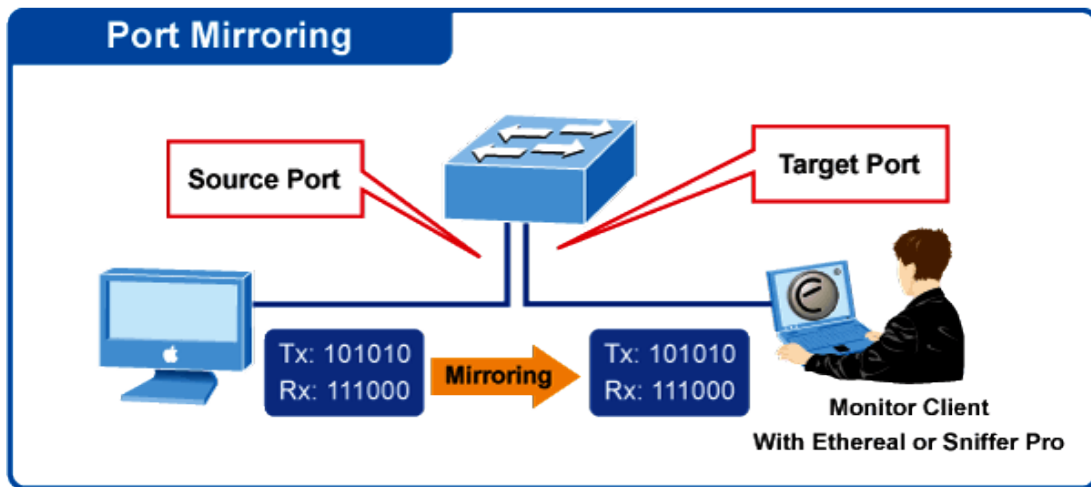

Figure 4-3-8 Port Mirror Application

The traffic to be copied to the mirror port is selected as follows:

- All frames received on a given port (also known as ingress or source mirroring).
- All frames transmitted on a given port (also known as egress or destination mirroring).

#### Mirror Port Configuration

The Port Mirror Configuration screens in [Figure 4-3-9](#) & [Figure 4-3-10](#) appear.

Mirror Setting	
Session ID	Select Session <input type="button" value="v"/>
Monitor session state	Disable <input type="button" value="v"/>
Destination Port	GE1 <input type="button" value="v"/>
allow-ingress	Disable <input type="button" value="v"/>
Sniffer RX Ports	Select RX Ports <input type="button" value="v"/>
Sniffer TX Ports	Select TX Ports <input type="button" value="v"/>

Figure 4-3-9 Port Mirroring Settings Page Screenshot



The page includes the following fields:

Object	Description
<ul style="list-style-type: none"> <li>• <b>Session ID</b></li> </ul>	Set the port mirror session ID. Possible ID are: <b>1</b> to <b>4</b> .
<ul style="list-style-type: none"> <li>• <b>Monitor Session State</b></li> </ul>	Enable or disable the port mirroring function.
<ul style="list-style-type: none"> <li>• <b>Destination Port</b></li> </ul>	Select the port to mirror destination port.
<ul style="list-style-type: none"> <li>• <b>Allow-ingress</b></li> </ul>	Frames from ports that have either source (rx) or destination (tx) mirroring enabled are mirrored to this port.
<ul style="list-style-type: none"> <li>• <b>Sniffer TX Ports</b></li> </ul>	Frames transmitted from these ports are mirrored to the mirroring port. Frames received are not mirrored.
<ul style="list-style-type: none"> <li>• <b>Sniffer RX Ports</b></li> </ul>	Frames received at these ports are mirrored to the mirroring port. Frames transmitted are not mirrored.

**Buttons**

: Click to apply changes.

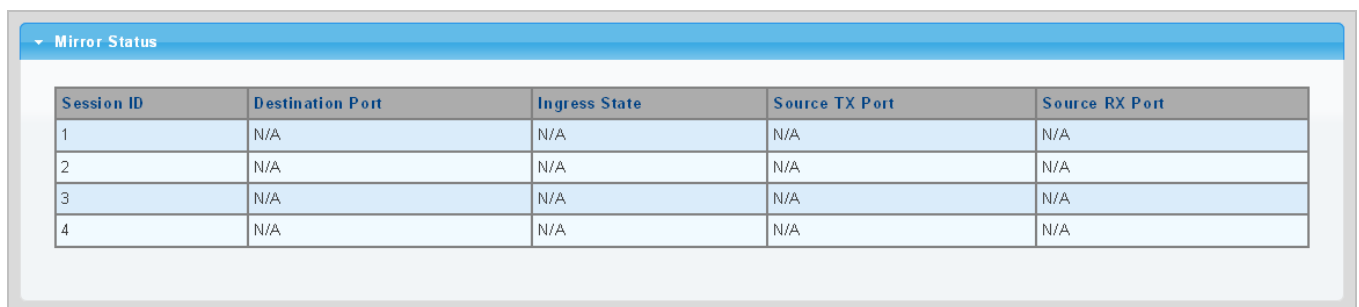

**Figure 4-3-10** Mirroring Status Page Screenshot

The page includes the following fields:

Object	Description
<ul style="list-style-type: none"> <li>• <b>Session ID</b></li> </ul>	Displays the session ID
<ul style="list-style-type: none"> <li>• <b>Destination Port</b></li> </ul>	This is the mirroring port entry
<ul style="list-style-type: none"> <li>• <b>Ingress State</b></li> </ul>	Displays the ingress state
<ul style="list-style-type: none"> <li>• <b>Source TX Port</b></li> </ul>	Displays the current TX ports
<ul style="list-style-type: none"> <li>• <b>Source RX Port</b></li> </ul>	Displays the current RX ports

### 4.3.5 Jumbo Frame

This page provides to select the **maximum frame size** allowed for the switch port. The Jumbo Frame screen in [Figure 4-3-11](#) & [Figure 4-3-12](#) appear.

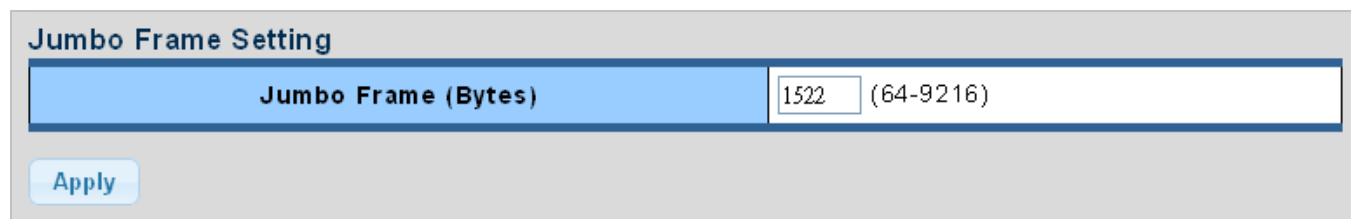

Figure 4-3-11 Jumbo Frame Setting Page Screenshot

The page includes the following fields:

Object	Description
<ul style="list-style-type: none"> <li>Jumbo Frame (Bytes)</li> </ul>	Enter the maximum frame size allowed for the switch port, including FCS. The allowed range is 64 bytes to 9216 bytes.

#### Buttons

: Click to apply changes.

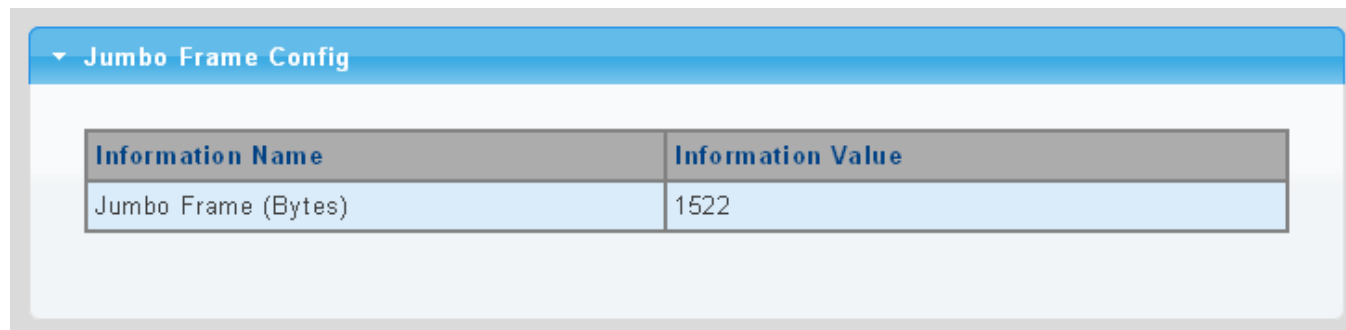

Figure 4-3-12 Jumbo Frame Information Page Screenshot

The page includes the following fields:

Object	Description
<ul style="list-style-type: none"> <li>Jumbo</li> </ul>	Displays the current maximum frame size

### 4.3.6 Port Error Disabled Configuration

This page provides to set port error disable function. The Port Error Disable Configuration screens in [Figure 4-3-13](#) & [Figure 4-3-14](#) appear.

Error Disabled Recovery	
Recovery Interval	<input type="text" value="300"/> (Seconds)
BPDU Guard	<input type="radio"/> Enabled <input checked="" type="radio"/> Disabled
Self Loop	<input type="radio"/> Enabled <input checked="" type="radio"/> Disabled
Broadcast Flood	<input type="radio"/> Enabled <input checked="" type="radio"/> Disabled
Unknown Multicast Flood	<input type="radio"/> Enabled <input checked="" type="radio"/> Disabled
Unicast Flood	<input type="radio"/> Enabled <input checked="" type="radio"/> Disabled
ACL	<input type="radio"/> Enabled <input checked="" type="radio"/> Disabled
Port Security Violation	<input type="radio"/> Enabled <input checked="" type="radio"/> Disabled
DHCP rate limit	<input type="radio"/> Enabled <input checked="" type="radio"/> Disabled
ARP rate limit	<input type="radio"/> Enabled <input checked="" type="radio"/> Disabled

Figure 4-3-13 Error Disabled Recovery Page Screenshot

The page includes the following fields:

Object	Description
• Recovery Interval	The period (in seconds) for which a port will be kept disabled in the event of a port error is detected (and the port action shuts down the port).
• BPDU Guard	Enable or disable the port error disabled function to check status by BPDU guard.
• Self Loop	Enable or disable the port error disabled function to check status by self loop.
• Broadcast Flood	Enable or disable the port error disabled function to check status by broadcast flood.
• Unknown Multicast Flood	Enable or disable the port error disabled function to check status by unknown multicast flood.
• Unicast Flood	Enable or disable the port error disabled function to check status by unicast flood.
• ACL	Enable or disable the port error disabled function to check status by ACL.
• Port Security Violation	Enable or disable the port error disabled function to check status by port security violation.
• DHCP Rate Limit	Enable or disable the port error disabled function to check status by DHCP rate limit
• ARP Rate Limit	Enable or disable the port error disabled function to check status by ARP rate limit

**Buttons**

: Click to apply changes.

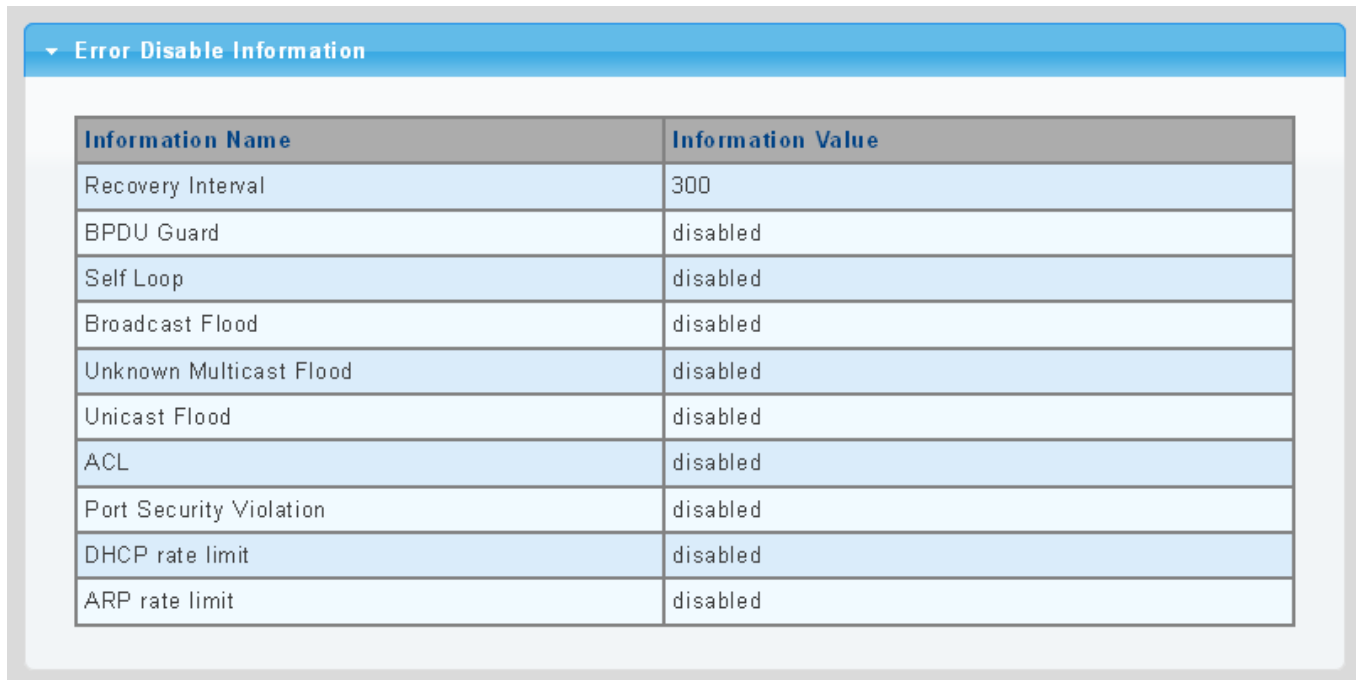

Error Disabled Information	
Information Name	Information Value
Recovery Interval	300
BPDU Guard	disabled
Self Loop	disabled
Broadcast Flood	disabled
Unknown Multicast Flood	disabled
Unicast Flood	disabled
ACL	disabled
Port Security Violation	disabled
DHCP rate limit	disabled
ARP rate limit	disabled

**Figure 4-3-14** Error Disabled Information Page Screenshot

The page includes the following fields:

Object	Description
• <b>Recovery Interval</b>	Displays the current recovery interval time
• <b>BPDU Guard</b>	Displays the current BPDU guard status
• <b>Self Loop</b>	Displays the current self loop status
• <b>Broadcast Flood</b>	Displays the current broadcast flood status
• <b>Unknown Multicast Flood</b>	Displays the current unknown multicast flood status
• <b>Unicast Flood</b>	Displays the current unicast flood status
• <b>ACL</b>	Displays the current ACL status
• <b>Port Security Violation</b>	Displays the current port security violation status
• <b>DHCP Rate Limit</b>	Displays the current DHCP rate limit status
• <b>ARP Rate Limit</b>	Displays the current ARP rate limit status

### 4.3.7 Port Error Disabled Status

This page provides disable that transitions a port into error disable and the recovery options.

The ports were disabled by some protocols such as **BPDU Guard**, **Loopback** and **UDLD**. The Port Error Disable screen in [Figure 4-3-15](#) appears.



Figure 4-3-15 Port Error Disable Page Screenshot

The displayed counters are:

Object	Description
• Port Name	Displays the port for error disable
• Error Disable Reason	Displays the error disabled reason of the port
• Time Left (Seconds)	Displays the time left

### 4.3.8 Protected Ports

#### Overview

When a switch port is configured to be a member of **protected group** (also called **Private VLAN**), communication between protected ports within that group can be prevented. Two application examples are provided in this section:

- Customers connected to an ISP can be members of the protected group, but they are not allowed to communicate with each other within that VLAN.
- Servers in a farm of web servers in a Demilitarized Zone (DMZ) are allowed to communicate with the outside world and with database servers on the inside segment, but are not allowed to communicate with each other

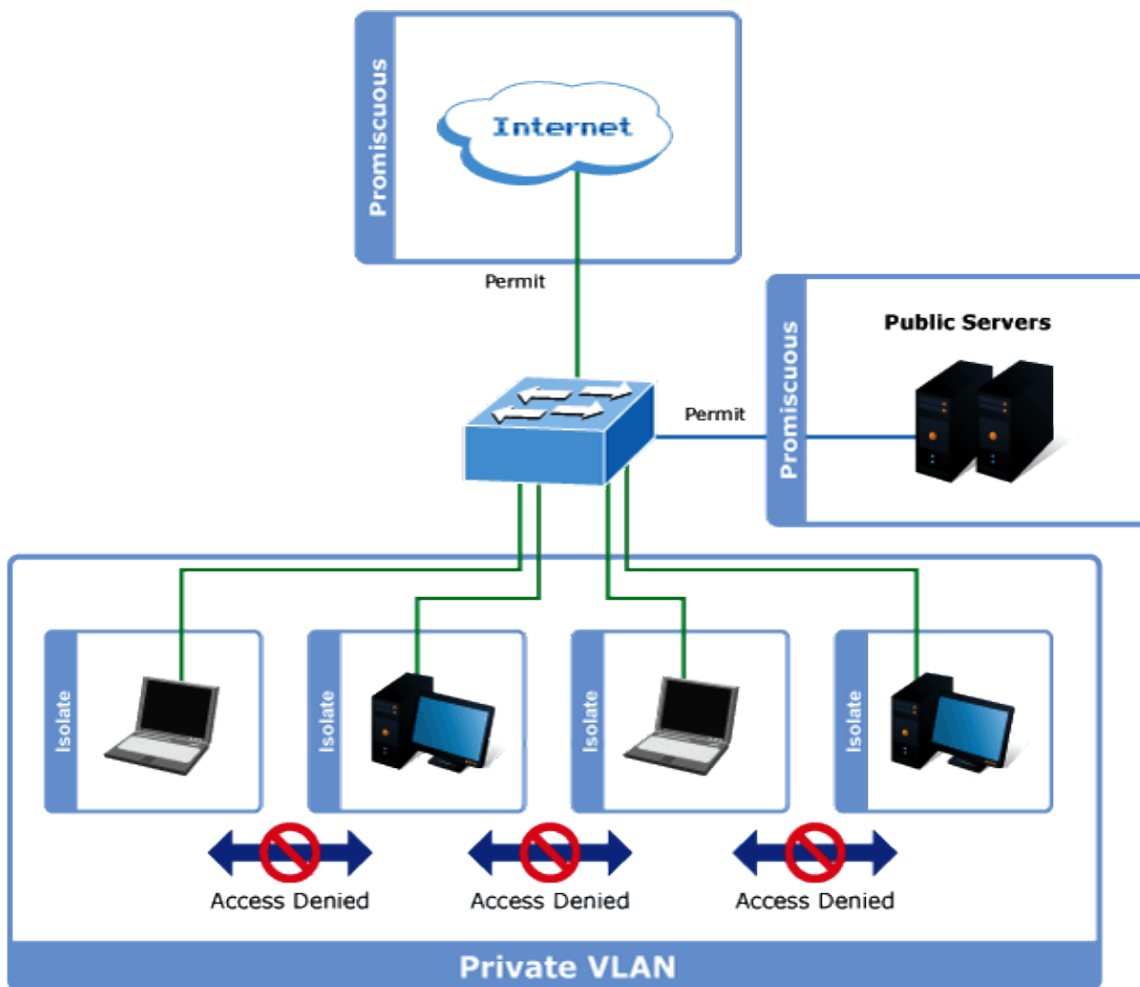

For protected port group to be applied, the Industrial Managed Switch must first be configured for standard VLAN operation.

Ports in a protected port group fall into one of these two groups:

- **Promiscuous (Unprotected) ports**
  - Ports from which traffic can be forwarded to all ports in the private VLAN
  - Ports which can receive traffic from all ports in the private VLAN
- **Isolated (Protected) ports**
  - Ports from which traffic can only be forwarded to promiscuous ports in the private VLAN
  - Ports which can receive traffic from only promiscuous ports in the private VLAN

The configuration of promiscuous and isolated ports applies to all private VLANs. When traffic comes in on a promiscuous port in a private VLAN, the VLAN mask from the VLAN table is applied. When traffic comes in on an isolated port, the private VLAN mask is applied in addition to the VLAN mask from the VLAN table. This reduces the ports to which forwarding can be done to just the promiscuous ports within the private VLAN.

The port settings relate to the currently unit, as reflected by the page header. The Port Isolation Configuration screens in [Figure 4-3-16](#) & [Figure 4-3-17](#) appear.

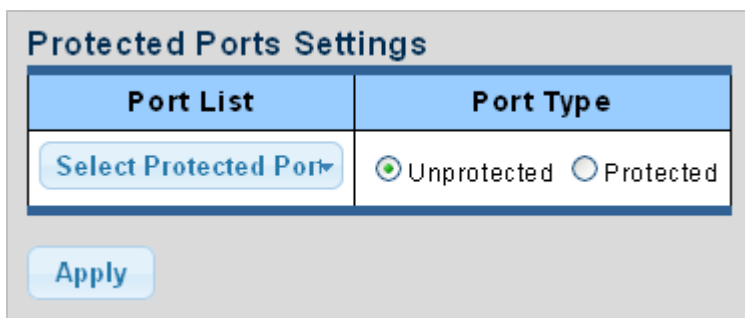

Figure 4-3-16 Protected Ports Settings Page Screenshot

The page includes the following fields:

Object	Description
<ul style="list-style-type: none"> <li>• <b>Port List</b></li> </ul>	Select port number for this drop down list.
<ul style="list-style-type: none"> <li>• <b>Port Type</b></li> </ul>	Displays protected port types. <ul style="list-style-type: none"> <li>- <b>Protected</b>: A single stand-alone VLAN that contains one promiscuous port and one or more isolated (or host) ports. This VLAN conveys traffic between the isolated ports and a lone promiscuous port.</li> <li>- <b>Unprotected</b>: A promiscuous port can communicate with all the interfaces within a private VLAN. This is the default setting.</li> </ul>

**Buttons**

**Apply**: Click to apply changes.

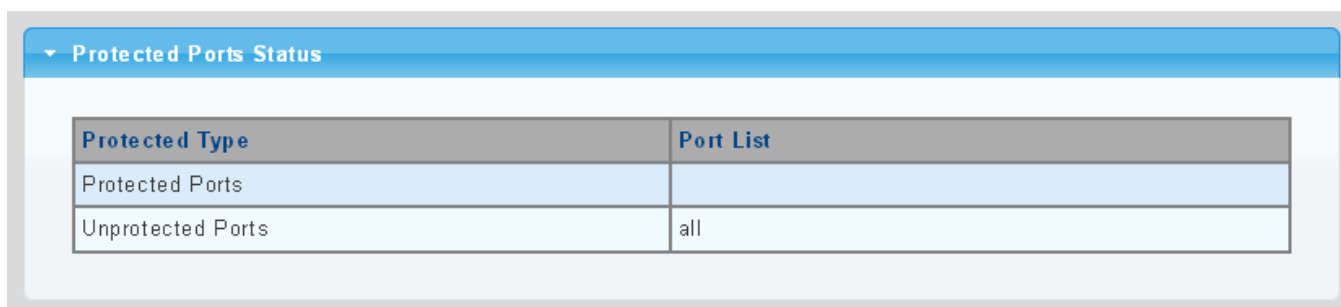

Figure 4-3-17 Port Isolation Status Page Screenshot

The page includes the following fields:

Object	Description
<ul style="list-style-type: none"> <li>• <b>Protected Ports</b></li> </ul>	Displays the current protected ports
<ul style="list-style-type: none"> <li>• <b>Unprotected Ports</b></li> </ul>	Displays the current unprotected ports

### 4.3.9 EEE

#### What is EEE

EEE is a power saving option that reduces the power usage when there is low or no traffic utilization. EEE works by powering down circuits when there is no traffic. When a port gets data to be transmitted all circuits are powered up. The time it takes to power up the circuits is named wakeup time. The default wakeup time is 17 us for 1Gbit links and 30 us for other link speeds. EEE devices must agree upon the value of the wakeup time in order to make sure that both the receiving and transmitting device has all circuits powered up when traffic is transmitted. The devices can exchange wakeup time information using the LLDP protocol. EEE works for ports in auto-negotiation mode, where the port is negotiated to either 1G or 100 Mbit full duplex mode. For ports that are not EEE-capable the corresponding EEE checkboxes are grayed out and thus impossible to enable EEE for. The EEE port settings relate to the currently unit, as reflected by the page header.

When a port is powered down for saving power, outgoing traffic is stored in a buffer until the port is powered up again. Because there are some overhead in turning the port down and up, more power can be saved if the traffic can be buffered up until a large burst of traffic can be transmitted. Buffering traffic will give some latency in the traffic.

The EEE Port Settings screen in [Figure 4-3-18](#) & [Figure 4-3-19](#) appears.

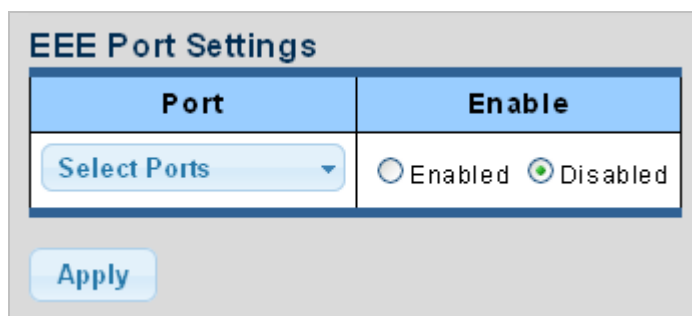

**Figure 4-3-18** EEE Port Settings Page Screenshot

The page includes the following fields:

Object	Description
• Port	Select port number for this drop down list
• Enable	Enable or disable the EEE function

#### Buttons

: Click to apply changes.



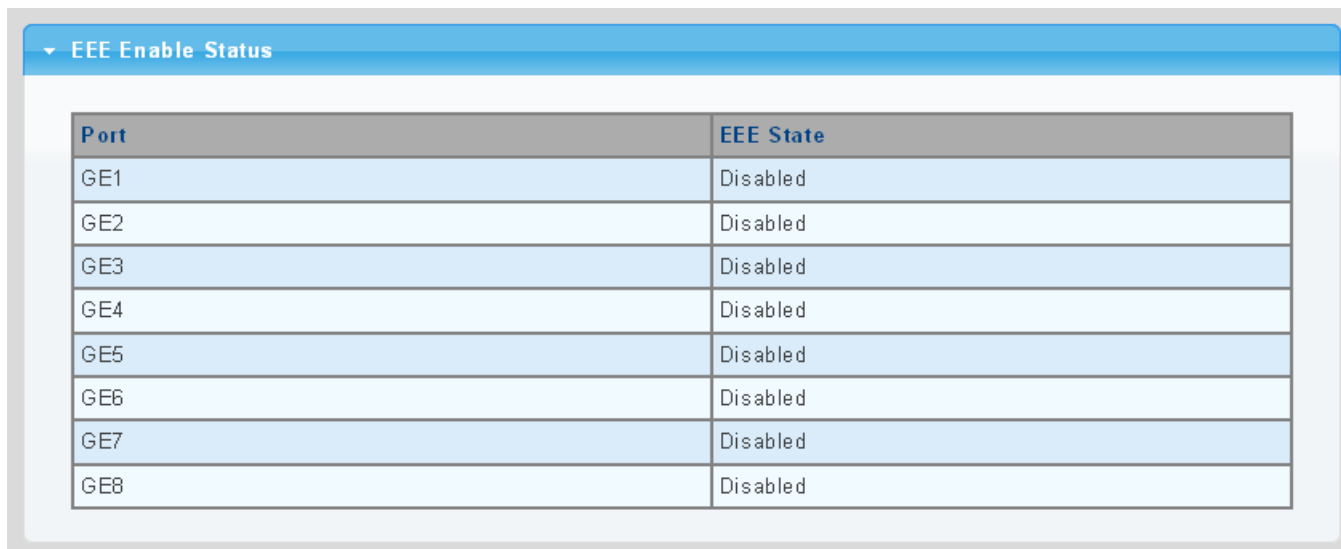

Port	EEE State
GE1	Disabled
GE2	Disabled
GE3	Disabled
GE4	Disabled
GE5	Disabled
GE6	Disabled
GE7	Disabled
GE8	Disabled

Figure 4-3-19 EEE Enable Status Page Screenshot

The page includes the following fields:

Object	Description
<ul style="list-style-type: none"> <li>Port</li> </ul>	The switch port number of the logical port
<ul style="list-style-type: none"> <li>EEE State</li> </ul>	Displays the current EEE state

### 4.3.10 SFP Module Information

Industrial Managed Switch has supported the SFP module with **digital diagnostics monitoring (DDM)** function, this feature is also known as digital optical monitoring (DOM). You can check the physical or operational status of an SFP module via the SFP Module Information Page. This Page shows the operational status, such as the transceiver type, speed, wavelength, optical output power, optical input power, temperature, laser bias current and transceiver supply voltage in real time. You can also use the hyperlink of port no. to check the statistics on a specific interface.

#### 4.3.10.1 SFP Module Status

The SFP Module Status screens in [Figure 4-3-20](#) & [Figure 4-3-21](#) appear.

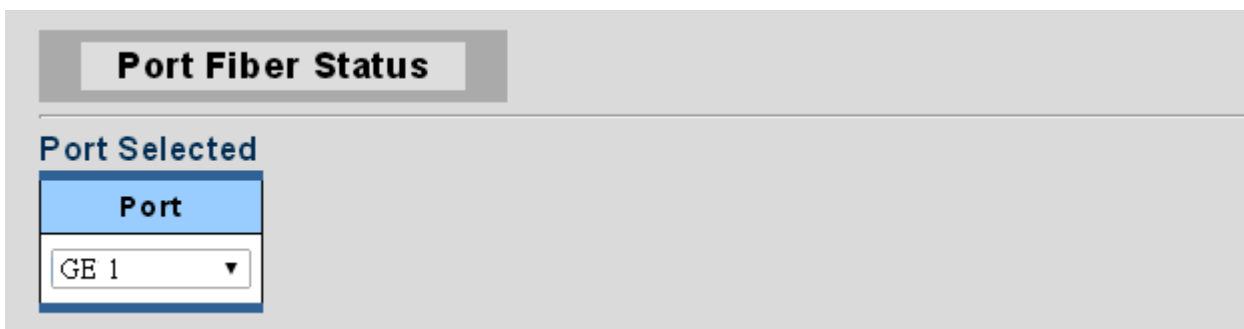

Figure 4-3-20 Port Selected Page Screenshot with Sample Switch

The page includes the following fields:

Object	Description
<ul style="list-style-type: none"> <li>• Port</li> </ul>	Select port number from this drop-down list



Figure 4-3-21 Fiber Port Status Page Screenshot

The page includes the following fields:

Object	Description
<ul style="list-style-type: none"> <li>• OE-Present</li> </ul>	Displays the current SFP OE-present
<ul style="list-style-type: none"> <li>• LOS</li> </ul>	Displays the current SFP LOS

### 4.3.10.1 SFP Module Detail Status

The SFP Module Detail Status screen in [Figure 4-3-22](#) appears.

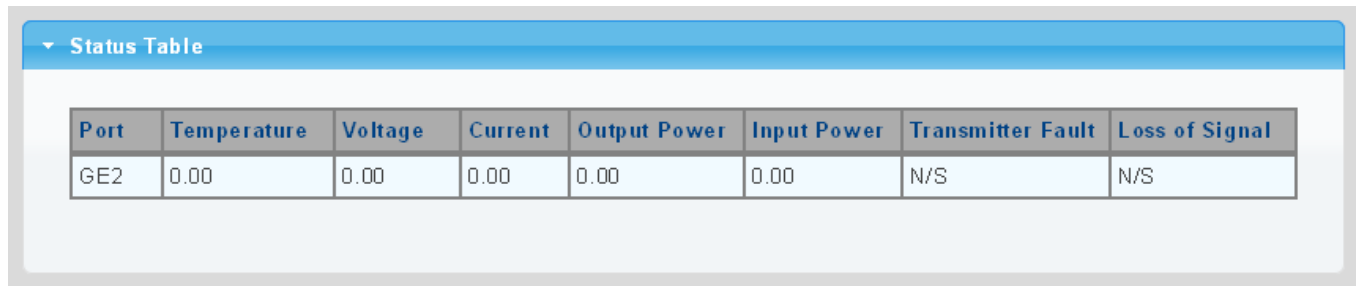

Status Table							
Port	Temperature	Voltage	Current	Output Power	Input Power	Transmitter Fault	Loss of Signal
GE2	0.00	0.00	0.00	0.00	0.00	N/S	N/S

**Figure 4-3-22** SFP Module Detail Status Page Screenshot with Sample Switch

The page includes the following fields:

Object	Description
• <b>Port</b>	The logical port for the settings contained in the same row
• <b>Temperature</b>	Displays the current SFP temperature
• <b>Voltage</b>	Displays the current SFP voltage
• <b>Current</b>	Displays the current SFP current
• <b>Output Power</b>	Displays the current SFP output power
• <b>Input Power</b>	Displays the current SFP input power
• <b>Transmit Fault</b>	Displays the current SFP transmits fault
• <b>Loss of Signal</b>	Displays the current SFP loss of signal.
• <b>Rate Ready</b>	Displays the current SFP rate ready.

## 4.4 Link Aggregation

Port Aggregation optimizes port usage by linking a group of ports together to form a single Link Aggregated Groups (LAGs).

Port Aggregation multiplies the bandwidth between the devices, increases port flexibility, and provides link redundancy.

Each LAG is composed of ports of the same speed, set to full-duplex operations. Ports in a LAG can be of different media types (UTP/Fiber, or different fiber types) provided they operate at the same speed.

Aggregated Links can be assigned manually (**Port Trunk**) or automatically by enabling Link Aggregation Control Protocol (**LACP**) on the relevant links.

Aggregated Links are treated by the system as a single logical port. Specifically, the Aggregated Link has similar port attributes to a non-aggregated port, including auto-negotiation, speed, duplex setting, etc.

The device supports the following Aggregation links :

- **Static LAGs (Port Trunk)** – Force aggregated selected ports to be a trunk group.
- **Link Aggregation Control Protocol (LACP)** LAGs - LACP LAG negotiate Aggregated Port links with other LACP ports located on a different device. If the other device ports are also LACP ports, the devices establish a LAG between them.

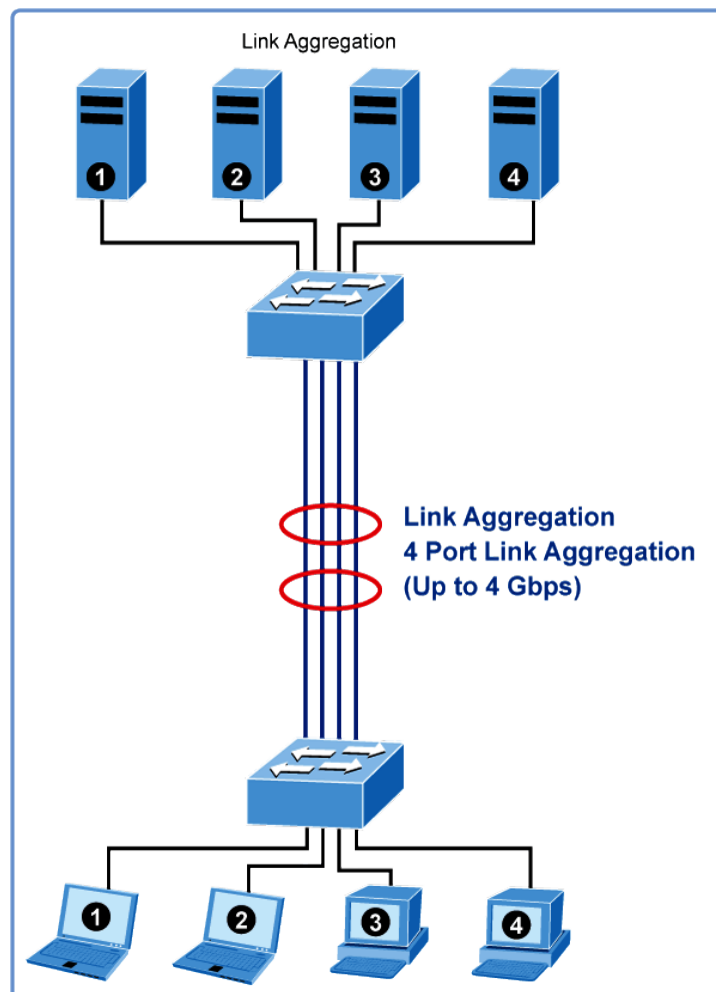

Figure 4-4-1 Link Aggregation

The **Link Aggregation Control Protocol (LACP)** provides a standardized means for exchanging information between Partner Systems that require high-speed redundant links. Link aggregation lets you group up to eight consecutive ports into a single dedicated connection. This feature can expand bandwidth to a device on the network. LACP operation requires full-duplex mode. For more detailed information, refer to the IEEE 802.3ad standard.

Port link aggregations can be used to increase the bandwidth of a network connection or to ensure fault recovery. Link aggregation lets you group up to 8 consecutive ports into a single dedicated connection between any two the Switch or other Layer 2 switches. However, before making any physical connections between devices, use the Link Aggregation Configuration menu to specify the link aggregation on the devices at both ends. When using a port link aggregation, note that:

- The ports used in a link aggregation must all be of the same media type (RJ45, 100 Mbps fiber).
- The ports that can be assigned to the same link aggregation have certain other restrictions (see below).
- Ports can only be assigned to one link aggregation.
- The ports at both ends of a connection must be configured as link aggregation ports.
- None of the ports in a link aggregation can be configured as a mirror source port or a mirror target port.
- All of the ports in a link aggregation have to be treated as a whole when moved from/to, added or deleted from a VLAN.
- The Spanning Tree Protocol will treat all the ports in a link aggregation as a whole.
- Enable the link aggregation prior to connecting any cable between the switches to avoid creating a data loop.
- Disconnect all link aggregation port cables or disable the link aggregation ports before removing a port link aggregation to avoid creating a data loop.

It allows a maximum of 8 ports to be aggregated at the same time. The Industrial Managed Switch supports Gigabit Ethernet ports (up to 8 groups). If the group is defined as an LACP static link aggregation group, then any extra ports selected are placed in a standby mode for redundancy if one of the other ports fails. If the group is defined as a local static link aggregation group, then the number of ports must be the same as the group member ports.

Use the Link Aggregation Menu to display or configure the Trunk function. This section has the following items:

- |                            |  |
|----------------------------|--|
| ■ <b>LAG Setting</b>       | Configures load balance algorithm configuration settings |
| ■ <b>LAG Management</b>    | Configures LAG configuration settings                    |
| ■ <b>LAG Port Setting</b>  | Configures LAG port settings                             |
| ■ <b>LACP Setting</b>      | Configures LACP priority settings                        |
| ■ <b>LACP Port Setting</b> | Configures LACP configuration settings                   |
| ■ <b>LAG Status</b>        | Displays LAG status / LACP information                   |

### 4.4.1 LAG Setting

This page allows configuring load balance algorithm configuration settings. The LAG Setting screens in [Figure 4-4-2](#) & [Figure 4-4-3](#) appear.

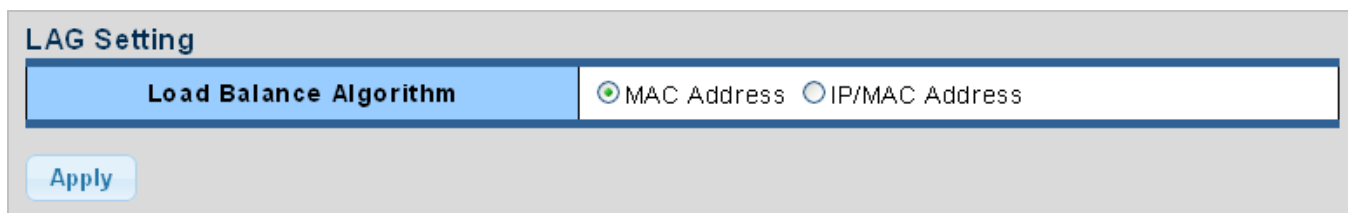

Figure 4-4-2 LAG Setting Page Screenshot

The page includes the following fields:

Object	Description
<ul style="list-style-type: none"> <li>• <b>Load Balance Algorithm</b></li> </ul>	Select load balance algorithm mode: <ul style="list-style-type: none"> <li>■ <b>MAC Address</b>: The MAC address can be used to calculate the port for the frame.</li> <li>■ <b>IP/MAC Address</b>: The IP and MAC address can be used to calculate the port for the frame.</li> </ul>

#### Buttons



: Click to apply changes.

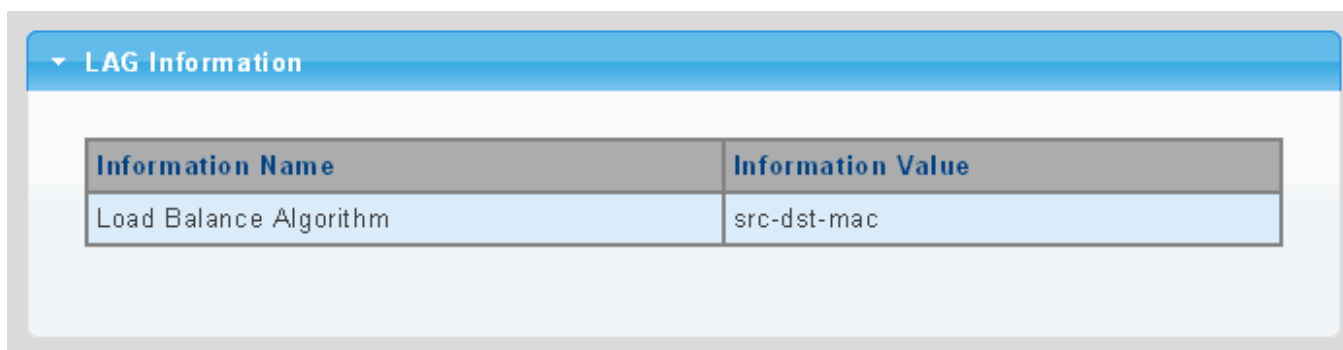

Figure 4-4-3 LAG Information Page Screenshot

The page includes the following fields:

Object	Description
<ul style="list-style-type: none"> <li>• <b>Load Balance Algorithm</b></li> </ul>	Displays the current load balance algorithm

### 4.4.2 LAG Management

This page is used to configure the LAG management. The LAG Management screens in [Figure 4-4-4](#) & [Figure 4-4-5](#) appear.

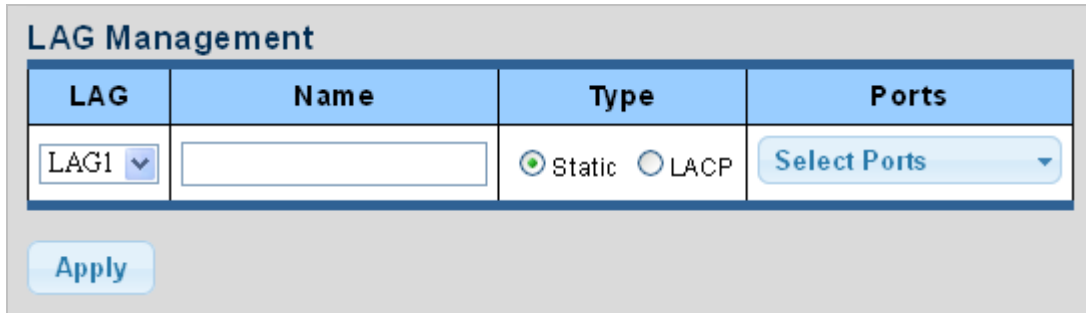

LAG	Name	Type	Ports
LAG1	<input type="text"/>	<input checked="" type="radio"/> Static <input type="radio"/> LACP	Select Ports

Apply

Figure 4-4-4 LAG Management Page Screenshot

The page includes the following fields:

Object	Description
• LAG	Select LAG number for this drop down list
• Name	Indicates each LAG name
• Type	Indicates the trunk type <b>Static:</b> Force aggregated selected ports to be a trunk group. <b>LACP:</b> LACP LAG negotiate Aggregated Port links with other LACP ports located on a different device. If the other device ports are also LACP ports, the devices establish a LAG between them.
• Ports	Select port number for this drop down list to establish Link Aggregation

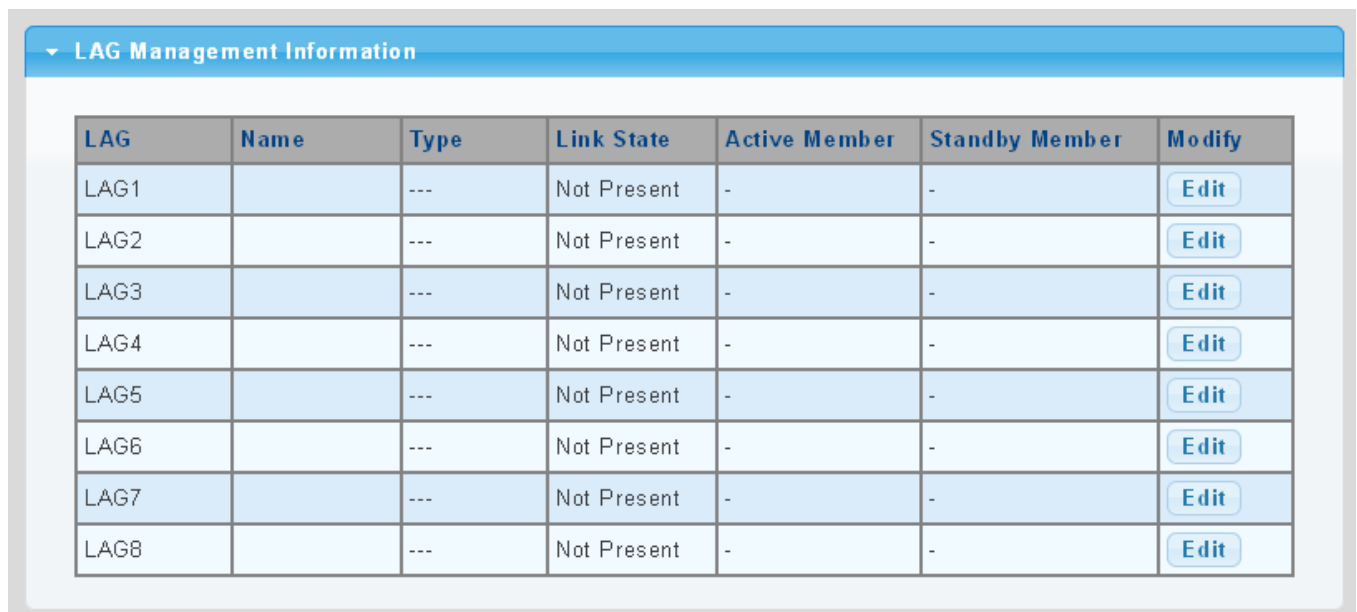

LAG	Name	Type	Link State	Active Member	Standby Member	Modify
LAG1		---	Not Present	-	-	Edit
LAG2		---	Not Present	-	-	Edit
LAG3		---	Not Present	-	-	Edit
LAG4		---	Not Present	-	-	Edit
LAG5		---	Not Present	-	-	Edit
LAG6		---	Not Present	-	-	Edit
LAG7		---	Not Present	-	-	Edit
LAG8		---	Not Present	-	-	Edit

Figure 4-4-5 LAG Management Information Page Screenshot

The page includes the following fields:

Object	Description
• LAG	The LAG for the settings contained in the same row
• Name	Displays the current name
• Type	Displays the current type
• Link State	Displays the link state
• Active Member	Displays the active member
• Standby Member	Displays the standby member
• Modify	Click  to modify LAG configuration

### 4.4.3 LAG Port Setting

This page allows setting configuration for each LAG. The LAG Port Setting screens in [Figure 4-4-6](#) & [Figure 4-4-7](#) appear.

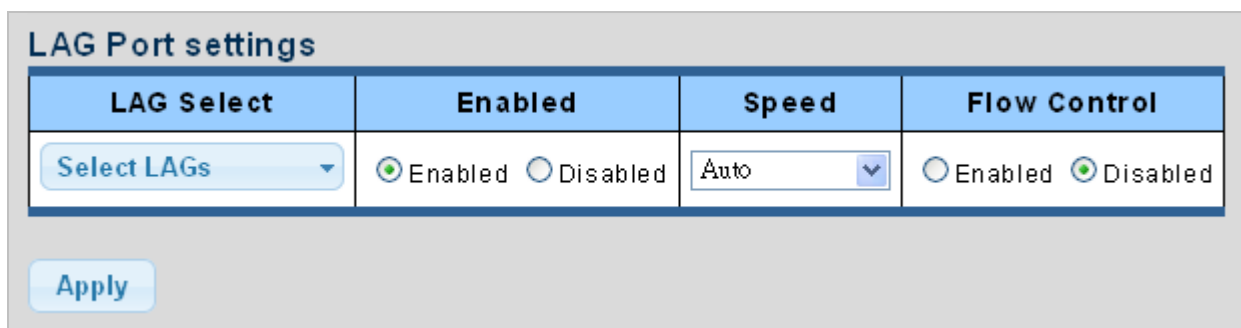

LAG Select	Enabled	Speed	Flow Control
Select LAGs	<input checked="" type="radio"/> Enabled <input type="radio"/> Disabled	Auto	<input type="radio"/> Enabled <input checked="" type="radio"/> Disabled

Apply

Figure 4-4-6 LAG Port Setting Information Page Screenshot

The page includes the following fields:

Object	Description
• LAG Select	Select LAG number for this drop down list.
• Enable	Indicates the LAG state operation. Possible states are: <b>Enabled</b> - Start up the LAG manually. <b>Disabled</b> - Shut down the LAG manually.
• Speed	Select any available link speed for the given switch port. Draw the menu bar to select the mode. <ul style="list-style-type: none"> <li>■ <b>Auto</b> - Set up Auto negotiation.</li> <li>■ <b>Auto-10M</b> - Set up 10M Auto negotiation.</li> <li>■ <b>Auto-100M</b> - Set up 100M Auto negotiation.</li> <li>■ <b>Auto-1000M</b> - Set up 1000M Auto negotiation.</li> <li>■ <b>Auto-10/100M</b> - Set up 10/100M Auto negotiation.</li> <li>■ <b>10M</b> - Set up 10M Force mode.</li> </ul>



	<ul style="list-style-type: none"> <li>■ <b>100M</b> – Set up 100M Force mode.</li> <li>■ <b>1000M</b> – Set up 1000M Force mode.</li> </ul>
<ul style="list-style-type: none"> <li>• <b>Flow Control</b></li> </ul>	<p>When Auto Speed is selected for a port, this section indicates the flow control capability that is advertised to the link partner. When a fixed-speed setting is selected, that is what is used. The current Rx column indicates whether pause frames on the port are obeyed. The current Tx column indicates whether pause frames on the port are transmitted. The Rx and Tx settings are determined by the result of the last Auto-Negotiation. Check the configured column to use flow control. This setting is related to the setting for Configured Link Speed.</p>

**Buttons**



: Click to apply changes.

▼ LAG Port Status

LAG	Description	Port Type	Enable State	Link Status	Speed	Duplex	FlowCtrl Config	FlowCtrl Status
LAG1			Enabled		Auto	Auto	Disabled	Disabled
LAG2			Enabled		Auto	Auto	Disabled	Disabled
LAG3			Enabled		Auto	Auto	Disabled	Disabled
LAG4			Enabled		Auto	Auto	Disabled	Disabled
LAG5			Enabled		Auto	Auto	Disabled	Disabled
LAG6			Enabled		Auto	Auto	Disabled	Disabled
LAG7			Enabled		Auto	Auto	Disabled	Disabled
LAG8			Enabled		Auto	Auto	Disabled	Disabled

**Figure 4-4-7** LAG Port Status Page Screenshot

The page includes the following fields:

Object	Description
• <b>LAG</b>	The LAG for the settings contained in the same row
• <b>Description</b>	Displays the current description
• <b>Port Type</b>	Displays the current port type
• <b>Enable State</b>	Displays the current enable state
• <b>Speed</b>	Displays the current speed
• <b>Duplex</b>	Displays the current duplex mode
• <b>Flow Control Config</b>	Displays the current flow control configuration
• <b>Flow Control Status</b>	Displays the current flow control status

### 4.4.4 LACP Setting

This page is used to configure the LACP system priority setting. The LACP Setting screens in [Figure 4-4-8](#) & [Figure 4-4-9](#) appear.

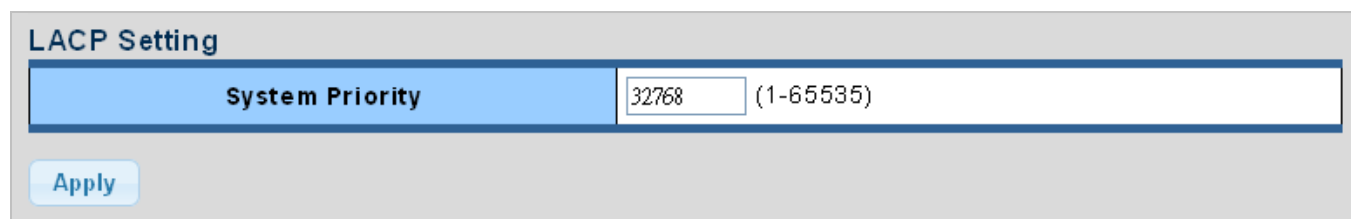

Figure 4-4-8 LACP Setting Page Screenshot

The page includes the following fields:

Object	Description
<ul style="list-style-type: none"> <li>System Priority</li> </ul>	<p>A value which is used to identify the active LACP.</p> <p>The Industrial Managed Switch with the lowest value has the highest priority and is selected as the active LACP peer of the trunk group.</p>

#### Buttons

: Click to apply changes.

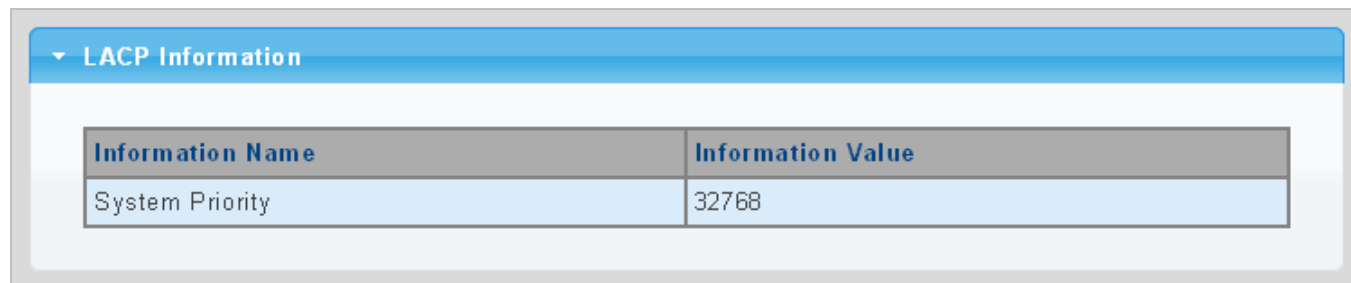

Figure 4-4-9 LACP Information Page Screenshot

The page includes the following fields:

Object	Description
<ul style="list-style-type: none"> <li>System Priority</li> </ul>	<p>Displays the current system priority.</p>

### 4.4.5 LACP Port Setting

This page is used to configure the LACP port setting. The LACP Port Setting screens in [Figure 4-4-10](#) & [Figure 4-4-11](#) appear.

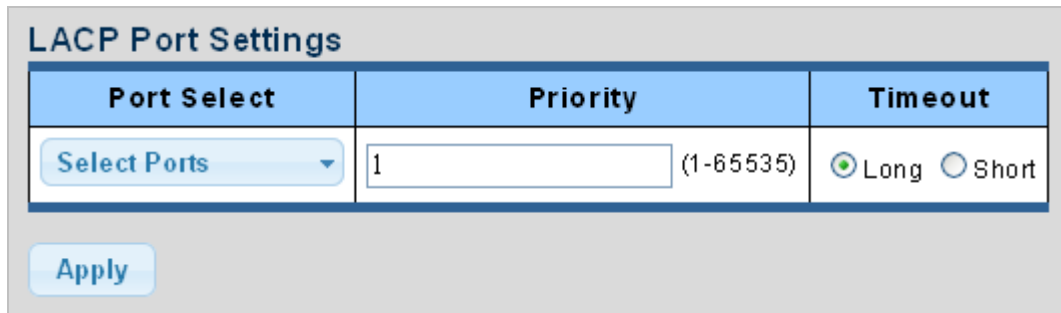

Port Select	Priority	Timeout
Select Ports	1 (1-65535)	<input checked="" type="radio"/> Long <input type="radio"/> Short

Apply

Figure 4-4-10 LACP Port Setting Page Screenshot

The page includes the following fields:

Object	Description
<ul style="list-style-type: none"> <li>Port Select</li> </ul>	Select port number for this drop down list to set LACP port setting.
<ul style="list-style-type: none"> <li>Priority</li> </ul>	<p>The Priority controls the priority of the port.</p> <p>If the LACP partner wants to form a larger group than is supported by this device, then this parameter will control which ports will be active and which ports will be in a backup role.</p> <p><b>Lower number means greater priority.</b></p>
<ul style="list-style-type: none"> <li>Timeout</li> </ul>	<p>The Timeout controls the period between BPDU transmissions.</p> <p>Short will transmit LACP packets each second, while Long will wait for 30 seconds before sending an LACP packet.</p>

#### Buttons

: Click to apply changes.

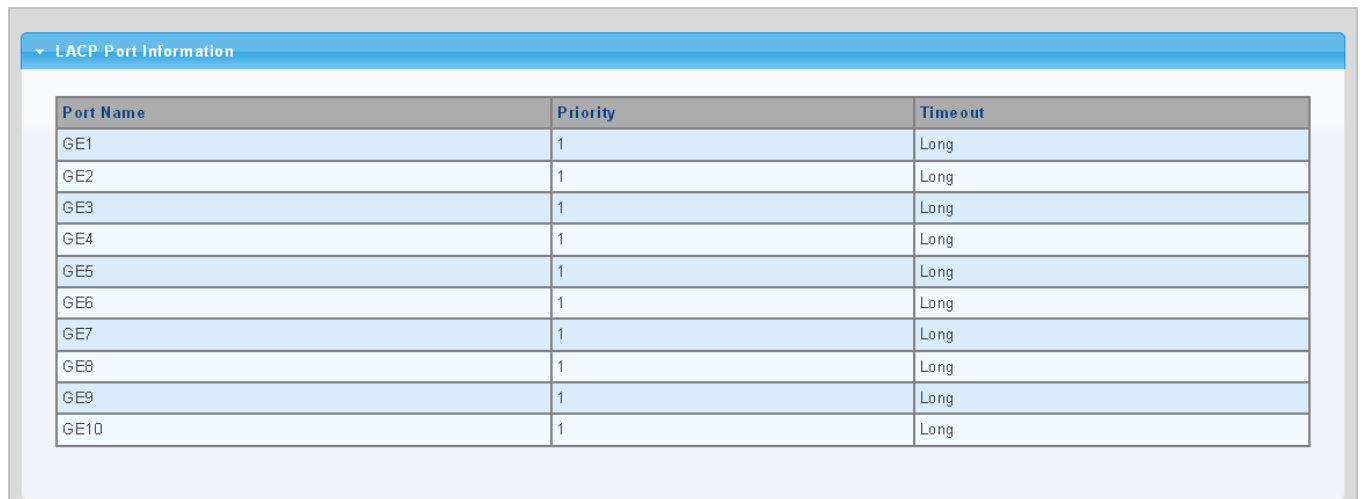

Port Name	Priority	Time out
GE1	1	Long
GE2	1	Long
GE3	1	Long
GE4	1	Long
GE5	1	Long
GE6	1	Long
GE7	1	Long
GE8	1	Long
GE9	1	Long
GE10	1	Long

Figure 4-4-11 LACP Port Information Page Screenshot

The page includes the following fields:

Object	Description
• Port Name	The switch port number of the logical port
• Priority	Displays the current LACP priority parameter
• Timeout	Displays the current timeout parameter

#### 4.4.6 LAG Status

This page displays LAG status. The LAG Status screens in [Figure 4-4-12](#) & [Figure 4-4-13](#) appear.

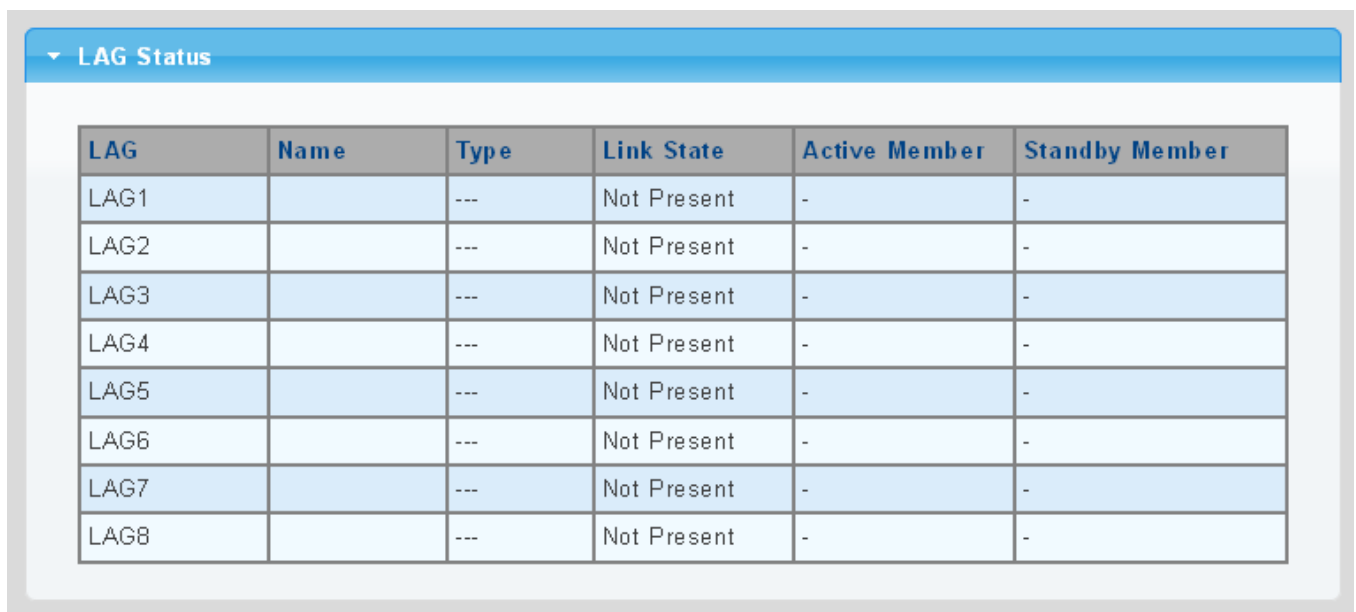

LAG	Name	Type	Link State	Active Member	Standby Member
LAG1		---	Not Present	-	-
LAG2		---	Not Present	-	-
LAG3		---	Not Present	-	-
LAG4		---	Not Present	-	-
LAG5		---	Not Present	-	-
LAG6		---	Not Present	-	-
LAG7		---	Not Present	-	-
LAG8		---	Not Present	-	-

Figure 4-4-12 LAG Status Page Screenshot

The page includes the following fields:

Object	Description
• LAG	Displays the current trunk entry
• Name	Displays the current LAG name
• Type	Displays the current trunk type
• Link State	Displays the current link state
• Active Member	Displays the current active member
• Standby Member	Displays the current standby member

LACP Information										
LAG	Port	PartnerSysId	PnKey	AtKey	Sel	Mux	Receiv	PrdTx	AtState	PnState
LAG1	GE1	000000000000	03e8	03e8	U	DETACH	DFLT	FstPRD	A_G__F_	_TG_C_F_
LAG1	GE2	000000000000	03e8	03e8	U	DETACH	DFLT	FstPRD	A_G__F_	_TG_C_F_

Figure 4-4-13 LACP Information Page Screenshot

The page includes the following fields:

Object	Description
• <b>Trunk</b>	Displays the current trunk ID
• <b>Port</b>	Displays the current port number
• <b>PartnerSysId</b>	The system ID of link partner. This field would be updated when the port receives LACP PDU from link partner
• <b>PnKey</b>	Port key of partner. This field would be updated when the port receives LACP PDU from link partner
• <b>AtKey</b>	Port key of actor. The key is designed to be the same as trunk ID.
• <b>Sel</b>	LACP selection logic status of the port <ul style="list-style-type: none"> <li>■ "S" means selected</li> <li>■ "U" means unselected</li> <li>■ "D" means standby</li> </ul>
• <b>Mux</b>	LACP mux state machine status of the port <ul style="list-style-type: none"> <li>■ "DETACH" means the port is in detached state</li> <li>■ "WAIT" means waiting state</li> <li>■ "ATTACH" means attach state</li> <li>■ "CLLCT" means collecting state</li> <li>■ "DSTRBT" means distributing state</li> </ul>
• <b>Receiv</b>	LACP receive state machine status of the port <ul style="list-style-type: none"> <li>■ "INIT" means the port is in initialize state</li> <li>■ "PORTds" means port disabled state</li> <li>■ "EXPR" means expired state</li> <li>■ "LACPs" means LACP disabled state</li> <li>■ "DFLT" means defaulted state</li> <li>■ "CRRNT" means current state</li> </ul>
• <b>PrdTx</b>	LACP periodic transmission state machine status of the port <ul style="list-style-type: none"> <li>■ "no PRD" means the port is in no periodic state</li> <li>■ "FstPRD" means fast periodic state</li> <li>■ "SlwPRD" means slow periodic state</li> <li>■ "PrdTX" means periodic TX state</li> </ul>
• <b>AtState</b>	The actor state field of LACP PDU description. The field from left to right describes: "LACP_Activity", "LACP_Timeout",

	<p>“Aggregation”, “Synchronization”, “Collecting”, “Distributing”, “Defaulted”, and “Expired”.</p> <p>The contents could be true or false. If the contents are false, the web shows “_”; if the contents are true, the web shows “A”, “T”, “G”, “S”, “C”, “D”, “F” and “E” for each content respectively.</p>
<ul style="list-style-type: none"> <li>• <b>PnState</b></li> </ul>	<p>The partner state field of LACP PDU description.</p> <p>The field from left to right describes: “LACP_Activity”, “LACP_Timeout”, “Aggregation”, “Synchronization”, “Collecting”, “Distributing”, “Defaulted”, and “Expired”.</p> <p>The contents could be true or false. If the contents are false, the web will show “_”; if the contents are true, the Web shows “A”, “T”, “G”, “S”, “C”, “D”, “F” and “E” for each content respectively.</p>

## 4.5 VLAN

### 4.5.1 VLAN Overview

A **Virtual Local Area Network (VLAN)** is a network topology configured according to a logical scheme rather than the physical layout. VLAN can be used to combine any collection of LAN segments into an autonomous user group that appears as a single LAN. VLAN also logically segment the network into different broadcast domains so that packets are forwarded only between ports within the VLAN. Typically, a VLAN corresponds to a particular subnet, although not necessarily.

VLAN can enhance performance by conserving bandwidth, and improve security by limiting traffic to specific domains.

A VLAN is a collection of end nodes grouped by logic instead of physical location. End nodes that frequently communicate with each other are assigned to the same VLAN, regardless of where they are physically on the network. Logically, a VLAN can be equated to a broadcast domain, because broadcast packets are forwarded to only members of the VLAN on which the broadcast was initiated.

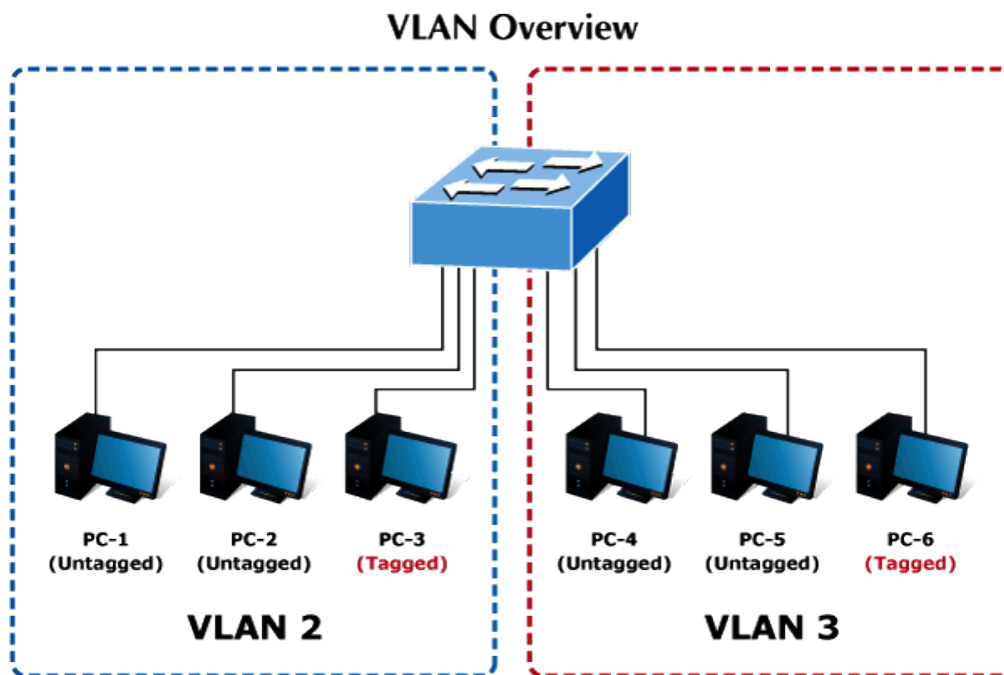

1. No matter what basis is used to uniquely identify end nodes and assign these nodes VLAN membership, packets cannot cross VLAN without a network device performing a routing function between the VLAN.
2. The Industrial Managed Switch supports IEEE 802.1Q VLAN. The port untagging function can be used to remove the 802.1 tag from packet headers to maintain compatibility with devices that are tag-unaware.



The Industrial Managed Switch's default is to assign all ports to a single 802.1Q VLAN named **DEFAULT\_VLAN**. As new VLAN is created, the member ports assigned to the new VLAN will be removed from the DEFAULT\_VLAN port member list. **The DEFAULT\_VLAN has a VID = 1.**

This section has the following items:

- |                                      |   |
|--------------------------------------|---|
| ■ <b>Management VLAN</b>             | Configures the management VLAN            |
| ■ <b>Create VLAN</b>                 | Creates the VLAN group                    |
| ■ <b>Interface Settings</b>          | Configures mode and PVID on the VLAN port |
| ■ <b>Port to VLAN</b>                | Configures the VLAN membership            |
| ■ <b>Port VLAN Membership</b>        | Displays the VLAN membership              |
| ■ <b>Protocol VLAN Group Setting</b> | Configures the protocol VLAN group        |
| ■ <b>Protocol VLAN Port Setting</b>  | Configures the protocol VLAN port setting |
| ■ <b>GVRP Setting</b>                | Configures GVRP global setting            |
| ■ <b>GVRP Port Setting</b>           | Configures GVRP port setting              |
| ■ <b>GVRP VLAN</b>                   | Displays the GVRP VLAN database           |
| ■ <b>GVRP Statistics</b>             | Displays the GVRP port statistics         |

#### **4.5.2 IEEE 802.1Q VLAN**

In large networks, routers are used to isolate broadcast traffic for each subnet into separate domains. This Industrial Managed Switch provides a similar service at Layer 2 by using VLANs to organize any group of network nodes into separate broadcast domains. VLANs confine broadcast traffic to the originating group, and can eliminate broadcast storms in large networks. This also provides a more secure and cleaner network environment.

An IEEE 802.1Q VLAN is a group of ports that can be located anywhere in the network, but communicate as though they belong to the same physical segment.

VLANs help to simplify network management by allowing you to move devices to a new VLAN without having to change any physical connections. VLANs can be easily organized to reflect departmental groups (such as Marketing or R&D), usage groups (such as e-mail), or multicast groups (used for multimedia applications such as videoconferencing).

VLANs provide greater network efficiency by reducing broadcast traffic, and allow you to make network changes without having to update IP addresses or IP subnets. VLANs inherently provide a high level of network security since traffic must pass through a configured Layer 3 link to reach a different VLAN.

This Industrial Managed Switch supports the following VLAN features:

- Up to 255 VLANs based on the IEEE 802.1Q standard
- Port overlapping, allowing a port to participate in multiple VLANs
- End stations can belong to multiple VLANs
- Passing traffic between VLAN-aware and VLAN-unaware devices



## IEEE 802.1Q Standard

IEEE 802.1Q (tagged) VLAN are implemented on the Switch. 802.1Q VLAN require tagging, which enables them to span the entire network (assuming all switches on the network are IEEE 802.1Q-compliant).

VLAN allow a network to be segmented in order to reduce the size of broadcast domains. All packets entering a VLAN will only be forwarded to the stations (over IEEE 802.1Q enabled switches) that are members of that VLAN, and this includes broadcast, multicast and unicast packets from unknown sources.

VLAN can also provide a level of security to your network. IEEE 802.1Q VLAN will only deliver packets between stations that are members of the VLAN. Any port can be configured as either **tagging** or **untagging**:

- The untagging feature of IEEE 802.1Q VLAN allows VLAN to work with legacy switches that don't recognize VLAN tags in packet headers.
- The tagging feature allows VLAN to span multiple 802.1Q-compliant switches through a single physical connection and allows Spanning Tree to be enabled on all ports and work normally.

Some relevant terms:

- **Tagging** - The act of putting 802.1Q VLAN information into the header of a packet.
- **Untagging** - The act of stripping 802.1Q VLAN information out of the packet header.

## 802.1Q VLAN Tags

The figure below shows the 802.1Q VLAN tag. There are four additional octets inserted after the source MAC address. Their presence is indicated by a value of **0x8100** in the Ether Type field. When a packet's Ether Type field is equal to 0x8100, the packet carries the IEEE 802.1Q/802.1p tag. The tag is contained in the following two octets and consists of 3 bits of user priority, 1 bit of Canonical Format Identifier (CFI - used for encapsulating Token Ring packets so they can be carried across Ethernet backbones), and 12 bits of **VLAN ID (VID)**. The 3 bits of user priority are used by 802.1p. The VID is the VLAN identifier and is used by the 802.1Q standard. Because the VID is 12 bits long, 4094 unique VLAN can be identified.

The tag is inserted into the packet header making the entire packet longer by 4 octets. All of the information originally contained in the packet is retained.

### 802.1Q Tag

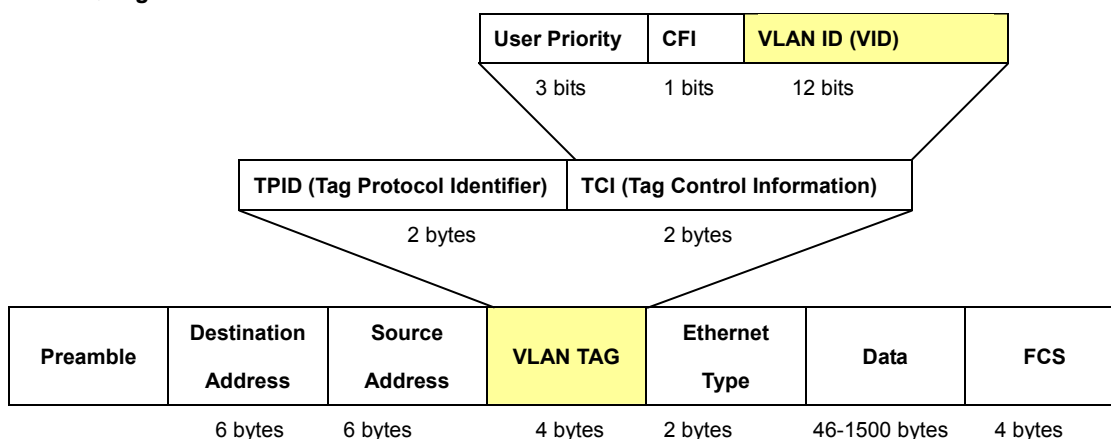

The Ether Type and VLAN ID are inserted after the MAC source address, but before the original Ether Type/Length or Logical Link Control. Because the packet is now a bit longer than it was originally, the Cyclic Redundancy Check (CRC) must be recalculated.

**Adding an IEEE802.1Q Tag**

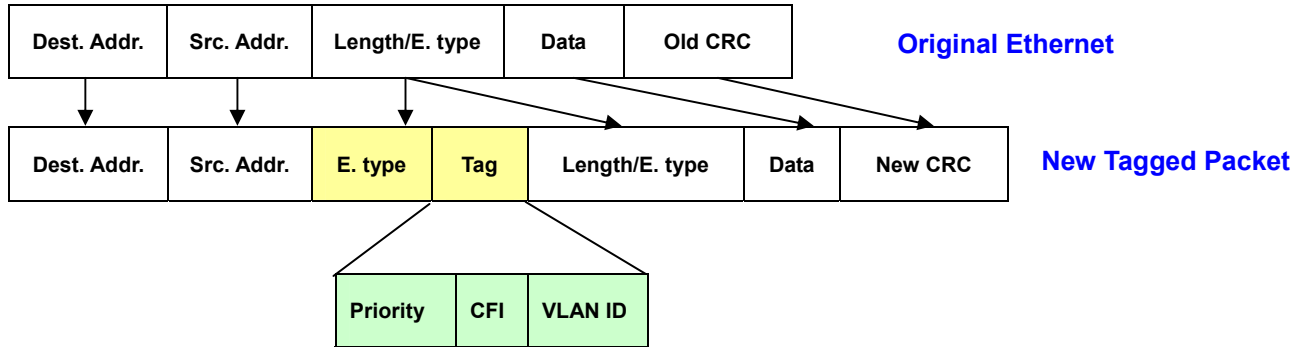

■ **Port VLAN ID**

Packets that are tagged (are carrying the 802.1Q VID information) can be transmitted from one 802.1Q compliant network device to another with the VLAN information intact. This allows 802.1Q VLAN to span network devices (and indeed, the entire network – if all network devices are 802.1Q compliant).

Every physical port on a switch has a PVID. 802.1Q ports are also assigned a PVID, for use within the switch. If no VLAN are defined on the switch, all ports are then assigned to a default VLAN with a PVID equal to 1. Untagged packets are assigned the PVID of the port on which they were received. Forwarding decisions are based upon this PVID, in so far as VLAN are concerned. Tagged packets are forwarded according to the VID contained within the tag. Tagged packets are also assigned a PVID, but the PVID is not used to make packet forwarding decisions, the VID is.

Tag-aware switches must keep a table to relate PVID within the switch to VID on the network. The switch will compare the VID of a packet to be transmitted to the VID of the port that is to transmit the packet. If the two VID are different the switch will drop the packet. Because of the existence of the PVID for untagged packets and the VID for tagged packets, tag-aware and tag-unaware network devices can coexist on the same network.

A switch port can have only one PVID, but can have as many VID as the switch has memory in its VLAN table to store them.

Because some devices on a network may be tag-unaware, a decision must be made at each port on a tag-aware device before packets are transmitted – should the packet to be transmitted have a tag or not? If the transmitting port is connected to a tag-unaware device, the packet should be untagged. If the transmitting port is connected to a tag-aware device, the packet should be tagged.

■ **Default VLANs**

The Switch initially configures one VLAN, VID = 1, called "**default.**" The factory default setting assigns all ports on the Switch to the "**default.**". As new VLAN are configured in Port-based mode, their respective member ports are removed from the "**default.**"

## ■ Assigning Ports to VLANs

Before enabling VLANs for the switch, you must first assign each port to the VLAN group(s) in which it will participate. By default all ports are assigned to VLAN 1 as untagged ports. Add a port as a tagged port if you want it to carry traffic for one or more VLANs, and any intermediate network devices or the host at the other end of the connection supports VLANs. Then assign ports on the other VLAN-aware network devices along the path that will carry this traffic to the same VLAN(s), either manually or dynamically using GVRP. However, if you want a port on this switch to participate in one or more VLANs, but none of the intermediate network devices nor the host at the other end of the connection supports VLANs, then you should add this port to the VLAN as an untagged port.



---

VLAN-tagged frames can pass through VLAN-aware or VLAN-unaware network interconnection devices, but the VLAN tags should be stripped off before passing it on to any end-node host that does not support VLAN tagging.

---

## ■ VLAN Classification

When the switch receives a frame, it classifies the frame in one of two ways. If the frame is untagged, the switch assigns the frame to an associated VLAN (based on the default VLAN ID of the receiving port). But if the frame is tagged, the switch uses the tagged VLAN ID to identify the port broadcast domain of the frame.

## ■ Port Overlapping

Port overlapping can be used to allow access to commonly shared network resources among different VLAN groups, such as file servers or printers. Note that if you implement VLANs which do not overlap, but still need to communicate, you can connect them by enabled routing on this switch.

## ■ Untagged VLANs

Untagged (or static) VLANs are typically used to reduce broadcast traffic and to increase security. A group of network users assigned to a VLAN form a broadcast domain that is separate from other VLANs configured on the switch. Packets are forwarded only between ports that are designated for the same VLAN. Untagged VLANs can be used to manually isolate user groups or subnets.

### 4.5.3 Management VLAN

Configure Management VLAN on this page. The screens in [Figure 4-5-1](#) & [Figure 4-5-2](#) appear.

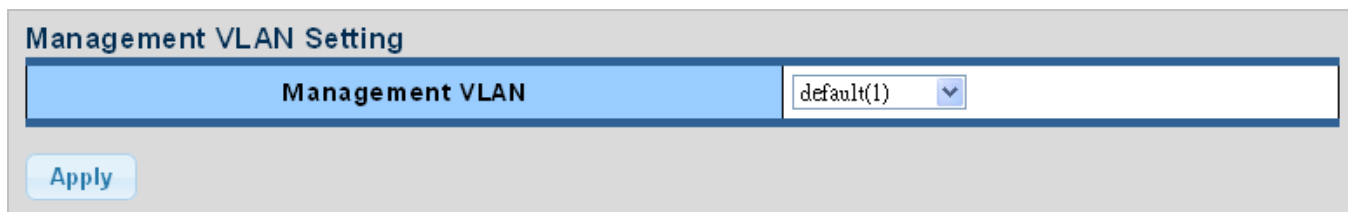

The screenshot shows a configuration page titled "Management VLAN Setting". It features a blue header bar with the title. Below the header is a form with a label "Management VLAN" and a dropdown menu currently showing "default(1)". An "Apply" button is located below the form.

Figure 4-5-1 Management VLAN Setting Page Screenshot

The page includes the following fields:

Object	Description
• Management VLAN	Provides the managed VLAN ID

#### Buttons



: Click to apply changes.

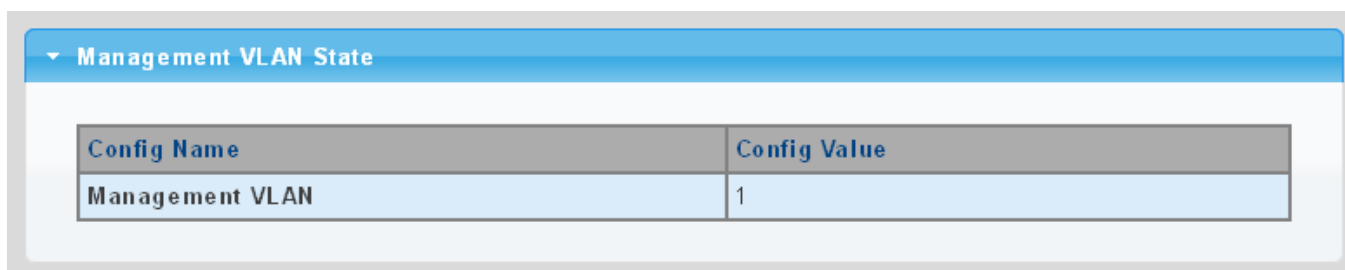

The screenshot shows a configuration page titled "Management VLAN State". It features a blue header bar with the title. Below the header is a table with two columns: "Config Name" and "Config Value". The table contains one row with "Management VLAN" in the first column and "1" in the second column.

Figure 4-5-2 Management VLAN State Page Screenshot

The page includes the following fields:

Object	Description
• Management VLAN	Displays the current management VLAN.

### 4.5.4 Create VLAN

Create/delete VLAN on this page. The screens in [Figure 4-5-3](#) & [Figure 4-5-4](#) appear.

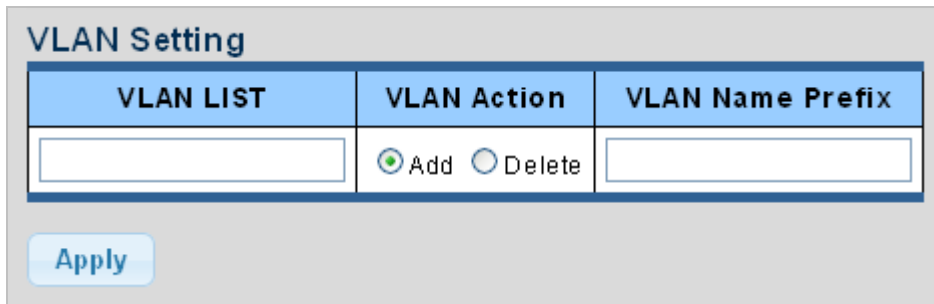

The screenshot shows a 'VLAN Setting' form with three columns: 'VLAN LIST', 'VLAN Action', and 'VLAN Name Prefix'. Below the columns are input fields and radio buttons for 'Add' and 'Delete'. An 'Apply' button is located at the bottom left.

Figure 4-5-3 VLAN Setting Page Screenshot

The page includes the following fields:

Object	Description
• VLAN List	Indicates the ID of this particular VLAN.
• VLAN Action	This column allows users to add or delete VLAN s.
• VLAN Name Prefix	Indicates the name of this particular VLAN.

#### Buttons

: Click to apply changes.

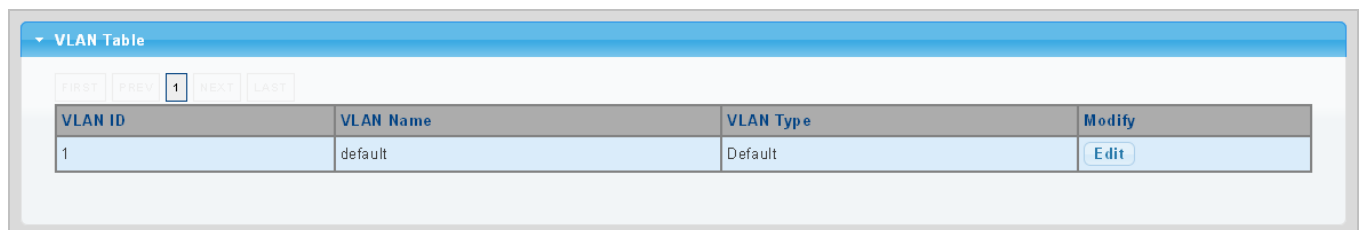

The screenshot shows a 'VLAN Table' with a table containing one entry. The table has columns for 'VLAN ID', 'VLAN Name', 'VLAN Type', and 'Modify'. The entry shows '1' for VLAN ID, 'default' for VLAN Name, and 'Default' for VLAN Type. An 'Edit' button is next to the entry.

Figure 4-5-4 VLAN Table Page Screenshot

The page includes the following fields:

Object	Description
• VLAN ID	Displays the current VLAN ID entry
• VLAN Name	Displays the current VLAN ID name
• VLAN Type	Displays the current VLAN ID type
• Modify	Click  to modify VLAN configuration

### 4.5.5 Interface Settings

This page is used for configuring the Industrial Managed Switch port VLAN. The VLAN per Port Configuration Page contains fields for managing ports that are part of a VLAN. The port **default VLAN ID (PVID)** is configured on the VLAN Port Configuration Page. All untagged packets arriving to the device are tagged by the ports PVID.

#### Understand nomenclature of the Switch

##### ■ IEEE 802.1Q Tagged and Untagged

Every port on an 802.1Q compliant switch can be configured as tagged or untagged.

- **Tagged:** Ports with tagging enabled will put the VID number, priority and other VLAN information into the header of all packets that flow into those ports. If a packet has previously been tagged, the port will not alter the packet, thus keeping the VLAN information intact. The VLAN information in the tag can then be used by other 802.1Q compliant devices on the network to make packet-forwarding decisions.
- **Untagged:** Ports with untagging enabled will strip the 802.1Q tag from all packets that flow into those ports. If the packet doesn't have an 802.1Q VLAN tag, the port will not alter the packet. Thus, all packets received by and forwarded by an untagging port will have no 802.1Q VLAN information. (Remember that the PVID is only used internally within the Switch). Untagging is used to send packets from an 802.1Q-compliant network device to a non-compliant network device.

Frame Income Frame Leave	Income Frame is <b>tagged</b>	Income Frame is <b>untagged</b>
Leave port is tagged	Frame remains tagged	Tag is inserted
Leave port is untagged	Tag is removed	Frame remain untagged

**Table 4-5-1:** Ingress/Egress Port with VLAN VID Tag/Untag Table

##### ■ IEEE 802.1Q Tunneling (Q-in-Q)

IEEE 802.1Q Tunneling (QinQ) is designed for service providers carrying traffic for multiple customers across their networks. QinQ tunneling is used to maintain customer-specific VLAN and Layer 2 protocol configurations even when different customers use the same internal VLAN IDs. This is accomplished by inserting **Service Provider VLAN (SPVLAN)** tags into the customer's frames when they enter the service provider's network, and then stripping the tags when the frames leave the network.

A service provider's customers may have specific requirements for their internal VLAN IDs and number of VLANs supported. VLAN ranges required by different customers in the same service-provider network might easily overlap, and traffic passing through the infrastructure might be mixed. Assigning a unique range of VLAN IDs to each customer would restrict customer configurations, require intensive processing of VLAN mapping tables, and could easily exceed the maximum VLAN limit of 4096.

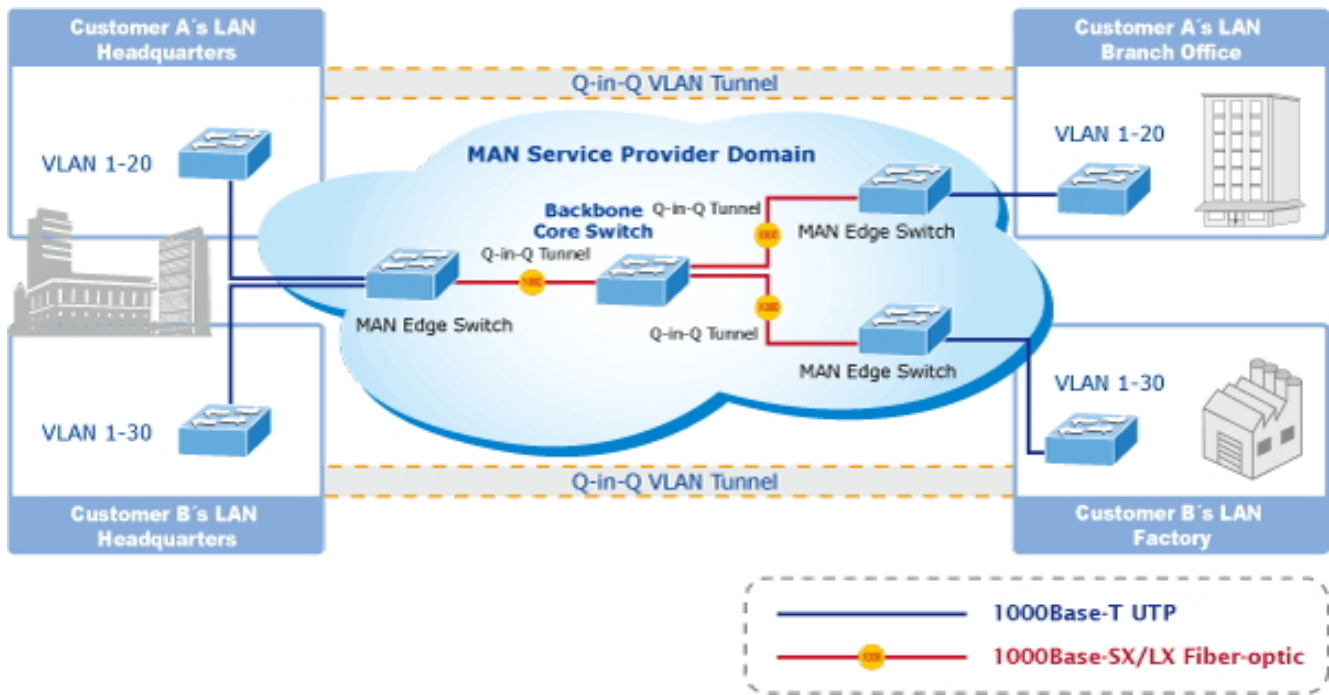

The Industrial Managed Switch supports multiple VLAN tags and can therefore be used in MAN applications as a provider bridge, aggregating traffic from numerous independent customer LANs into the **MAN (Metro Access Network)** space. One of the purposes of the provider bridge is to recognize and use VLAN tags so that the VLANs in the MAN space can be used independent of the customers' VLANs. This is accomplished by adding a VLAN tag with a MAN-related VID for frames entering the MAN. When leaving the MAN, the tag is stripped and the original VLAN tag with the customer-related VID is again available.

This provides a tunneling mechanism to connect remote customer VLANs through a common MAN space without interfering with the VLAN tags. All tags use EtherType **0x8100** or **0x88A8**, where 0x8100 is used for customer tags and 0x88A8 are used for service provider tags.

In cases where a given service VLAN only has two member ports on the switch, the learning can be disabled for the particular VLAN and can therefore rely on flooding as the forwarding mechanism between the two ports. This way, the MAC table requirements is reduced.

### Edit Interface Setting

The Edit Interface Setting/Status screens in [Figure 4-5-5](#) & [Figure 4-5-6](#) appear.

Port Select	Interface VLAN Mode	PVID	Accepted Type	Ingress Filtering	Uplink	TPID
Select Ports	<input checked="" type="radio"/> Hybrid Tunnel <input type="radio"/> Access <input type="radio"/> Trunk <input type="radio"/>	1 (1 - 4094)	<input checked="" type="radio"/> All Only <input type="radio"/> Tag Only <input type="radio"/> Untag	<input checked="" type="radio"/> Enabled <input type="radio"/> Disabled	<input type="radio"/> Enabled <input checked="" type="radio"/> Disabled	0x8100

Apply

Figure 4-5-5 Edit Interface Setting Page Screenshot

The page includes the following fields:

Object	Description
<ul style="list-style-type: none"> <li>• <b>Port Select</b></li> </ul>	Select port number from this drop-down list to set VLAN port setting.
<ul style="list-style-type: none"> <li>• <b>Interface VLAN Mode</b></li> </ul>	<p>Set the port in access, trunk, hybrid and tunnel mode.</p> <ul style="list-style-type: none"> <li>■ <b>Trunk</b> means the port allows traffic of multiple VLANs.</li> <li>■ <b>Access</b> indicates the port belongs to one VLAN only.</li> <li>■ <b>Hybrid</b> means the port allows the traffic of multi-VLANs to pass in tag or untag mode.</li> <li>■ <b>Tunnel</b> configures IEEE 802.1Q tunneling for a downlink port to another device within the customer network.</li> </ul>
<ul style="list-style-type: none"> <li>• <b>PVID</b></li> </ul>	<p>Allows you to assign PVID to selected port.</p> <p>The PVID will be inserted into all untagged frames entering the ingress port. The PVID must be the same as the VLAN ID that the port belongs to VLAN group, or the untagged traffic will be dropped.</p> <p>The range for the PVID is <b>1-4094</b>.</p>
<ul style="list-style-type: none"> <li>• <b>Accepted Type</b></li> </ul>	<p>Determines whether the port accepts all frames or only tagged frames. This parameter affects VLAN ingress processing. If the port only accepts tagged frames, untagged frames received on the port are discarded.</p> <p>Options:</p> <ul style="list-style-type: none"> <li>■ <b>All</b></li> <li>■ <b>Tag Only</b></li> <li>■ <b>Untag Only</b></li> </ul> <p>By default, the field is set to <b>All</b>.</p>
<ul style="list-style-type: none"> <li>• <b>Ingress Filtering</b></li> </ul>	<ul style="list-style-type: none"> <li>• If ingress filtering is enabled (checkbox is checked), frames classified to a VLAN that the port is not a member of get discarded.</li> <li>• If ingress filtering is disabled, frames classified to a VLAN that the port is not a member of are accepted and forwarded to the switch engine.</li> </ul> <p>However, the port will never transmit frames classified to VLANs that it is not a member of.</p>
<ul style="list-style-type: none"> <li>• <b>Uplink</b></li> </ul>	Enable/disable uplink function in trunk port.
<ul style="list-style-type: none"> <li>• <b>TPID</b></li> </ul>	Configures the type (TPID) of the protocol of switch trunk port.

**Buttons**

: Click to apply changes.



▼ Port VLAN Status

Port	Interface VLAN Mode	PVID	Accept Frame Type	Ingress Filtering	Uplink	TPID
GE1	Trunk	1	ALL	Enabled	Disabled	0x8100
GE2	Trunk	1	ALL	Enabled	Disabled	0x8100
GE3	Trunk	1	ALL	Enabled	Disabled	0x8100
GE4	Trunk	1	ALL	Enabled	Disabled	0x8100
GE5	Trunk	1	ALL	Enabled	Disabled	0x8100
GE6	Trunk	1	ALL	Enabled	Disabled	0x8100
GE7	Trunk	1	ALL	Enabled	Disabled	0x8100
GE8	Trunk	1	ALL	Enabled	Disabled	0x8100
GE9	Trunk	1	ALL	Enabled	Disabled	0x8100
GE10	Trunk	1	ALL	Enabled	Disabled	0x8100
LAG1	Trunk	1	ALL	Enabled	Disabled	0x8100
LAG2	Trunk	1	ALL	Enabled	Disabled	0x8100
LAG3	Trunk	1	ALL	Enabled	Disabled	0x8100
LAG4	Trunk	1	ALL	Enabled	Disabled	0x8100
LAG5	Trunk	1	ALL	Enabled	Disabled	0x8100
LAG6	Trunk	1	ALL	Enabled	Disabled	0x8100
LAG7	Trunk	1	ALL	Enabled	Disabled	0x8100
LAG8	Trunk	1	ALL	Enabled	Disabled	0x8100

Figure 4-5-6 Edit Interface Setting Page Screenshot

The page includes the following fields:

Object	Description
• Port	The switch port number of the logical port
• Interface VLAN Mode	Displays the current interface VLAN mode
• PVID	Displays the current PVID
• Accepted Frame Type	Displays the current access frame type
• Ingress Filtering	Displays the current ingress filtering
• Uplink	Displays the current uplink mode
• TPID	Displays the current TPID

### 4.5.6 Port to VLAN

Use the VLAN Static Table to configure port members for the selected VLAN index. This page allows you to add and delete port members of each VLAN. The screen in [Figure 4-5-7](#) appears.

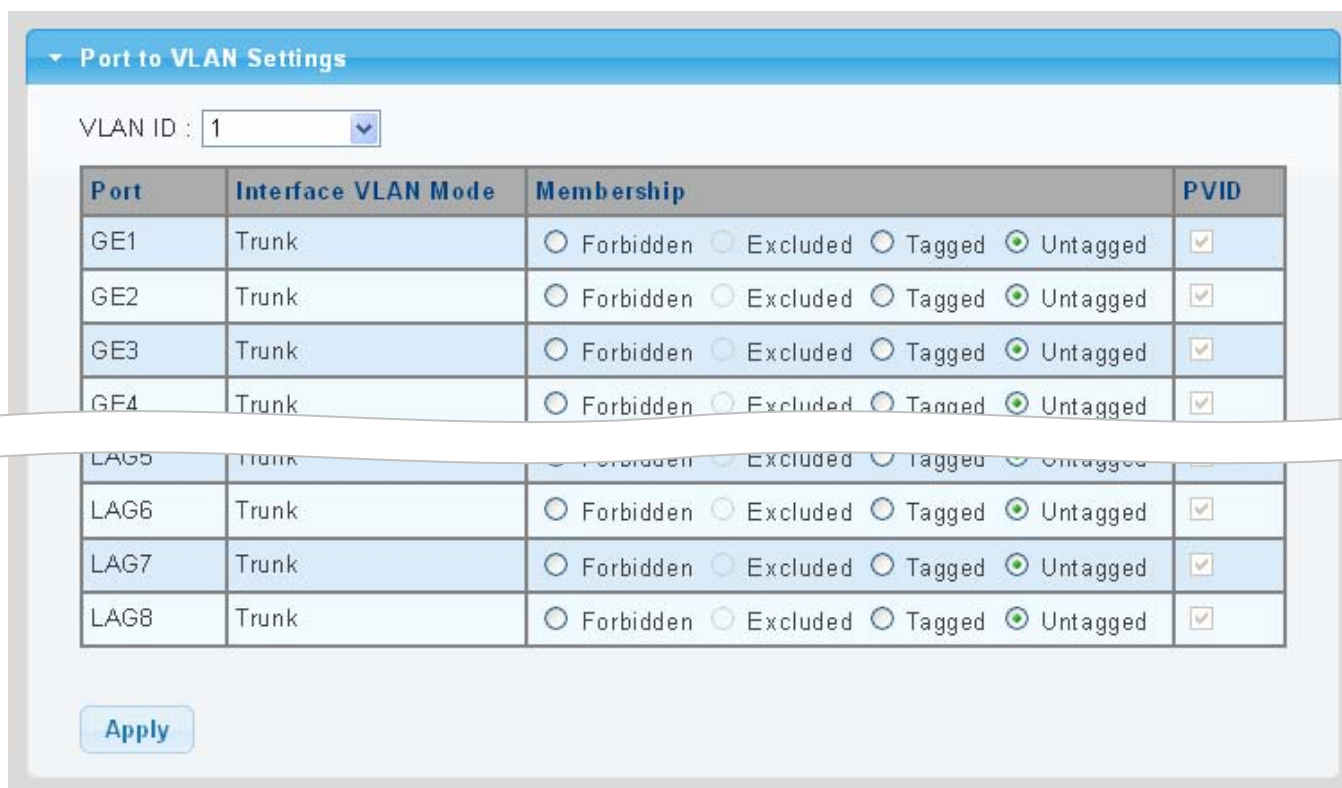

**Figure 4-5-7** Port to VLAN Setting Page Screenshot

The page includes the following fields:

Object	Description
• <b>VLAN ID</b>	Select VLAN ID for this drop down list to assign VLAN membership.
• <b>Port</b>	The switch port number of the logical port.
• <b>Interface VLAN Mode</b>	Displays the current interface VLAN mode.
• <b>Membership</b>	Select VLAN membership for each interface by marking the appropriate radio button for a port or trunk:
<b>Forbidden:</b>	Interface is forbidden from automatically joining the VLAN via GVRP.
<b>Excluded:</b>	Interface is not a member of the VLAN. Packets associated with this VLAN will not be transmitted by the interface.
<b>Tagged:</b>	Interface is a member of the VLAN. All packets transmitted by the port will be tagged, that is, carry a tag and therefore carry VLAN or CoS information.
<b>Untagged:</b>	Interface is a member of the VLAN. All packets transmitted by the port will be untagged, that is, not carry a tag and therefore not

	carry VLAN or CoS information. Note that an interface must be assigned to at least one group as an untagged port.
• PVID	Displays the current PVID

**Buttons**

 : Click to apply changes.

**4.5.7 Port VLAN Membership**

This page provides an overview of membership status for VLAN users. The VLAN Membership Status screen in [Figure 4-5-8](#) appears.

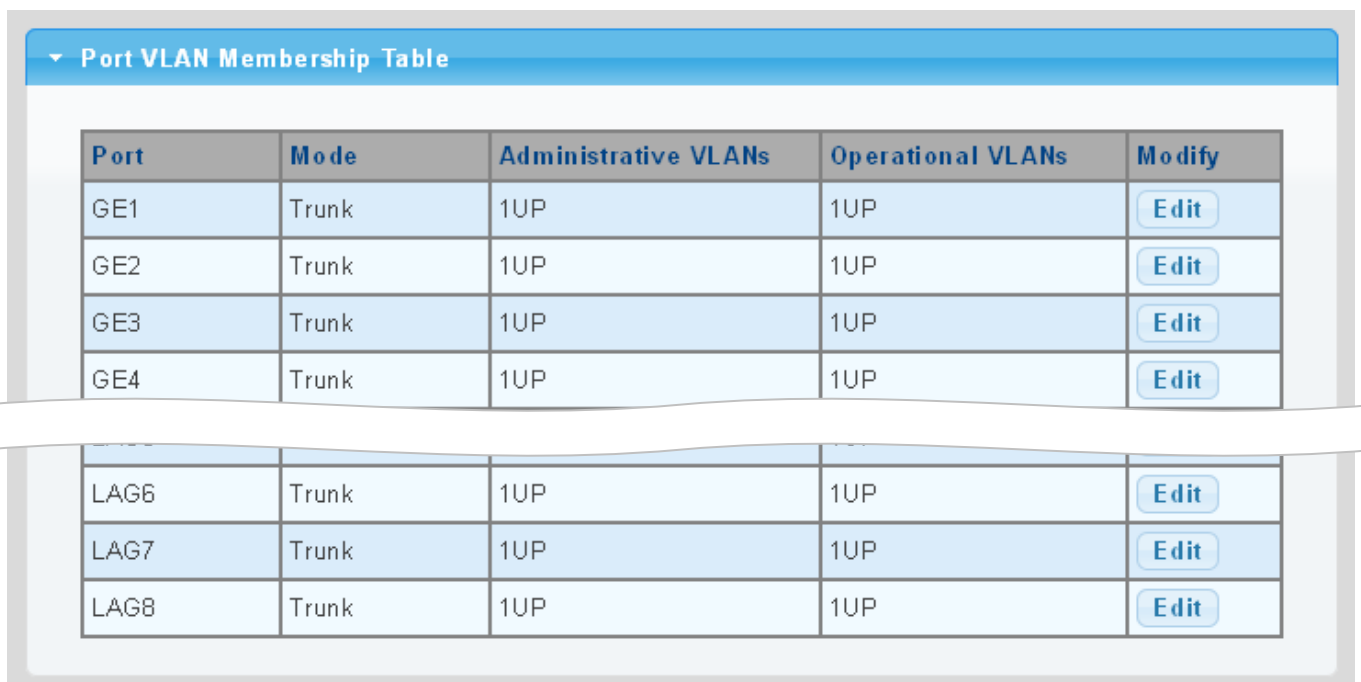

Port	Mode	Administrative VLANs	Operational VLANs	Modify
GE1	Trunk	1UP	1UP	<a href="#">Edit</a>
GE2	Trunk	1UP	1UP	<a href="#">Edit</a>
GE3	Trunk	1UP	1UP	<a href="#">Edit</a>
GE4	Trunk	1UP	1UP	<a href="#">Edit</a>
LAG6	Trunk	1UP	1UP	<a href="#">Edit</a>
LAG7	Trunk	1UP	1UP	<a href="#">Edit</a>
LAG8	Trunk	1UP	1UP	<a href="#">Edit</a>

**Figure 4-5-8** Port VLAN Membership Table Page Screenshot

The page includes the following fields:

Object	Description
• Port	The switch port number of the logical port
• Mode	Displays the current VLAN mode
• Administrative VLANs	Displays the current administrative VLANs
• Operational VLANs	Displays the current operational VLANs
• Modify	Click  to modify VLAN membership

### 4.5.8 Protocol VLAN Group Setting

The network devices required to support multiple protocols cannot be easily grouped into a common VLAN. This may require non-standard devices to pass traffic between different VLANs in order to encompass all the devices participating in a specific protocol. This kind of configuration deprives users of the basic benefits of VLANs, including security and easy accessibility.

To avoid these problems, you can configure this Industrial Managed Switch with protocol-based VLANs that divide the physical network into logical VLAN groups for each required protocol. When a frame is received at a port, its VLAN membership can then be determined based on the protocol type being used by the inbound packets.

#### Command Usage

To configure protocol-based VLANs, follow these steps:

1. First configure **VLAN groups for the protocols** you want to use. Although not mandatory, we suggest configuring a separate VLAN for each major protocol running on your network. Do not add port members at this time.
2. Create a **protocol group** for each of the protocols you want to assign to a VLAN using the Protocol VLAN Configuration page.
3. Then map the protocol for each interface to the appropriate VLAN using the Protocol VLAN Port Configuration page.

This page allows you to configure protocol-based VLAN Group Setting. The protocol-based VLAN screens in [Figure 4-5-9](#) & [Figure 4-5-10](#) appear.

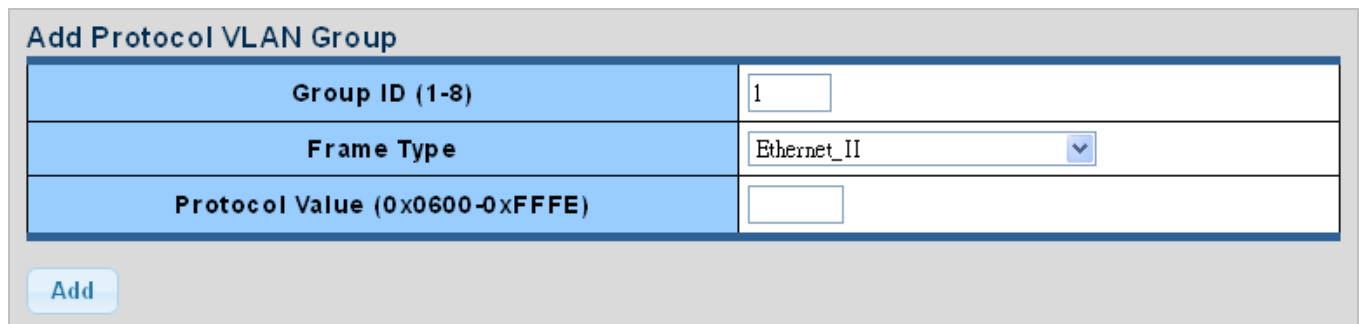

Figure 4-5-9 Add Protocol VLAN Group Page Screenshot

The page includes the following fields:

Object	Description
• <b>Group ID</b>	Protocol Group ID assigned to the Special Protocol VLAN Group.
• <b>Frame Type</b>	<p>Frame Type can have one of the following values:</p> <ul style="list-style-type: none"> <li>■ <b>Ethernet II</b></li> <li>■ <b>IEEE802.3_LL_C_Other</b></li> <li>■ <b>RFC_1042</b></li> </ul> <p><b>Note:</b> On changing the Frame type field, valid value of the following text field will vary depending on the new frame type you selected.</p>
• <b>Protocol Value (0x0600-0xFFFE)</b>	<p>Valid value that can be entered in this text field depends on the option selected from the preceding Frame Type selection menu.</p> <p>Valid values for frame type ranges from 0x0600-0xfffe</p>

**Buttons**

: Click to apply changes.

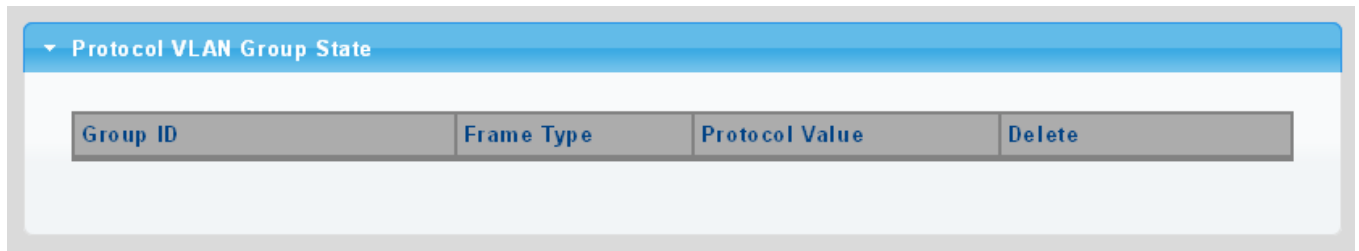

**Figure 4-5-10** Protocol VLAN Group State Page Screenshot

The page includes the following fields:

Object	Description
• <b>Group ID</b>	Displays the current group ID
• <b>Frame Type</b>	Displays the current frame type
• <b>Protocol Value</b>	Displays the current protocol value
• <b>Delete</b>	Click  to delete the group ID entry

### 4.5.9 Protocol VLAN Port Setting

This page allows you to map an already configured Group Name to a VLAN/port for the switch. The Protocol VLAN Port Setting/State screens in [Figure 4-5-11](#) & [Figure 4-5-12](#) appear.

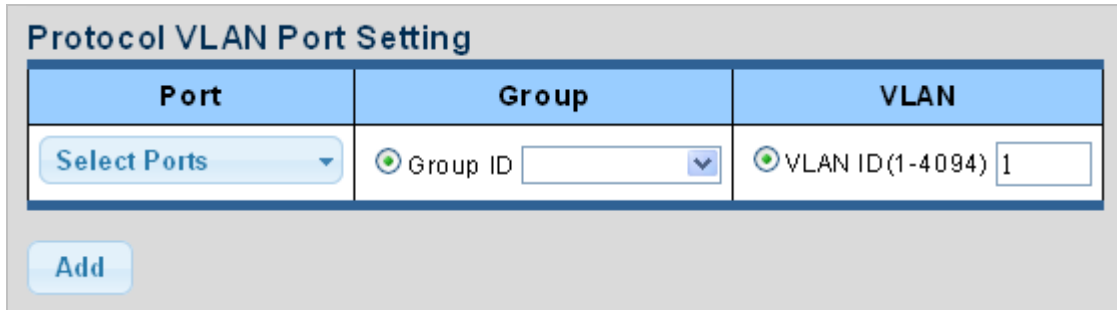



Figure 4-5-11 Protocol VLAN Port Setting Page Screenshot

The page includes the following fields:

Object	Description
• Port	Select port for this drop down list to assign protocol VLAN port
• Group	Select group ID for this drop down list to protocol VLAN group
• VLAN	VLAN ID assigned to the Special Protocol VLAN Group

#### Buttons

: Click to add protocol VLAN port entry.

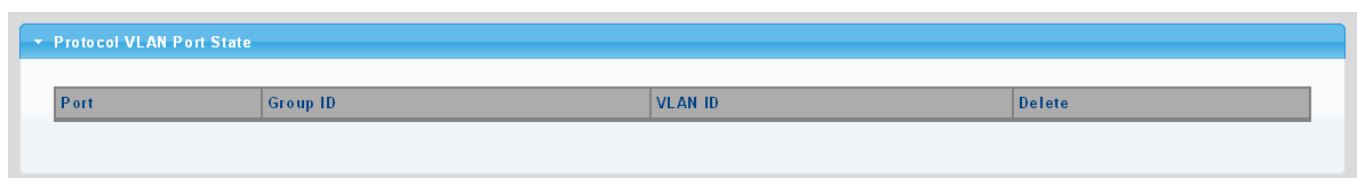



Figure 4-5-12 Protocol VLAN Port State Page Screenshot

The page includes the following fields:

Object	Description
• Port	Displays the current port
• Group ID	Displays the current group ID
• VLAN ID	Displays the current VLAN ID
• Delete	Click  to delete the group ID entry

### 4.5.10 GVRP Setting

**GARP VLAN Registration Protocol (GVRP)** defines a way for switches to exchange VLAN information in order to register VLAN members on ports across the network.

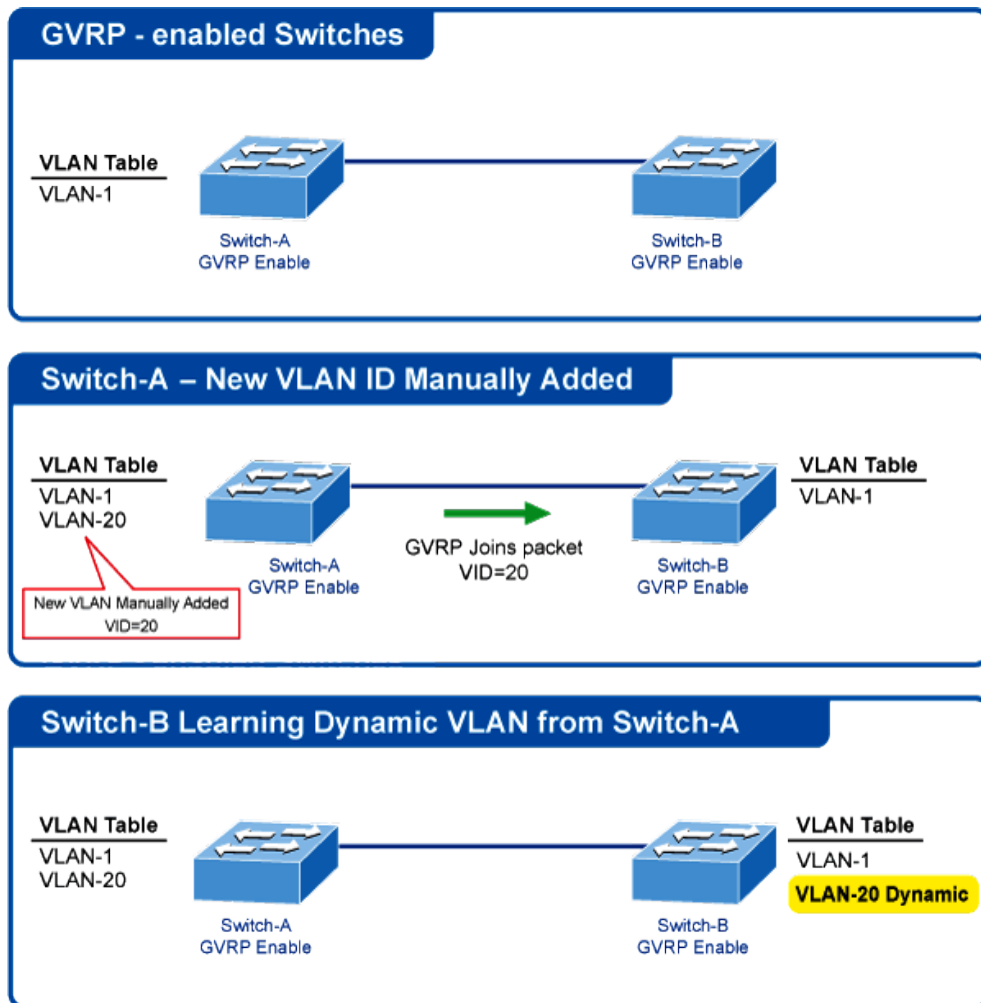

VLANs are **dynamically** configured based on **join messages** issued by host devices and propagated throughout the network. GVRP must be enabled to permit automatic VLAN registration, and to support VLANs which extend beyond the local switch.

The GVRP Global Setting/Information screens in [Figure 4-5-13](#) & [Figure 4-5-14](#) appear.

**GVRP Global Setting**

<b>GVRP</b>	<input checked="" type="radio"/> Disable <input type="radio"/> Enable
<b>Join Timeout</b>	20 (20-16375 centiseconds)
<b>Leave Timeout</b>	60 (45-32760 centiseconds)
<b>LeaveAll Timeout</b>	1000 (65-32765 centiseconds)

Apply

Figure 4-5-13 GVRP Global Setting Page Screenshot

The page includes the following fields:

Object	Description
• <b>GVRP</b>	Controls whether GVRP is enabled or disabled on this switch.
• <b>Join Timeout</b>	The interval between transmitting requests/queries to participate in a VLAN group. Range: 20-16375 centiseconds Default: <b>20</b> centiseconds
• <b>Leave Timeout</b>	The interval a port waits before leaving a VLAN group. This time should be set to more than twice the join time. This ensures that after a Leave or LeaveAll message has been issued, the applicants can rejoin before the port actually leaves the group. Range: 45-32760 centiseconds Default: <b>60</b> centiseconds
• <b>LeaveAll Timeout</b>	The interval between sending out a LeaveAll query message for VLAN group participants and the port leaving the group. This interval should be considerably larger than the Leave Time to minimize the amount of traffic generated by nodes rejoining the group. Range: 65-32765 centiseconds; Default: <b>1000</b> centiseconds



Timer settings must follow this rule:

$$2 \times (\text{join timer}) < \text{leave timer} < \text{leaveAll timer}$$

**Buttons**



: Click to apply changes.

GVRP Informations	
Information Name	Information Value
GVRP Status	Disabled
Join Timeout	200 millisecond
Leave Timeout	600 millisecond
LeaveAll Time out	10000 millisecond

Figure 4-5-14 GVRP Global Setting Page Screenshot



The page includes the following fields:

Object	Description
• <b>GVRP Status</b>	Displays the current GVRP status
• <b>Join Timeout</b>	Displays the current join timeout parameter
• <b>Leave Timeout</b>	Displays the current leave timeout parameter
• <b>LeaveAll Timeout</b>	Displays the current leaveall timeout parameter

### 4.5.11 GVRP Port Setting

The GVRP Port Setting/Status screens in [Figure 4-5-15](#) & [Figure 4-5-16](#) appear.

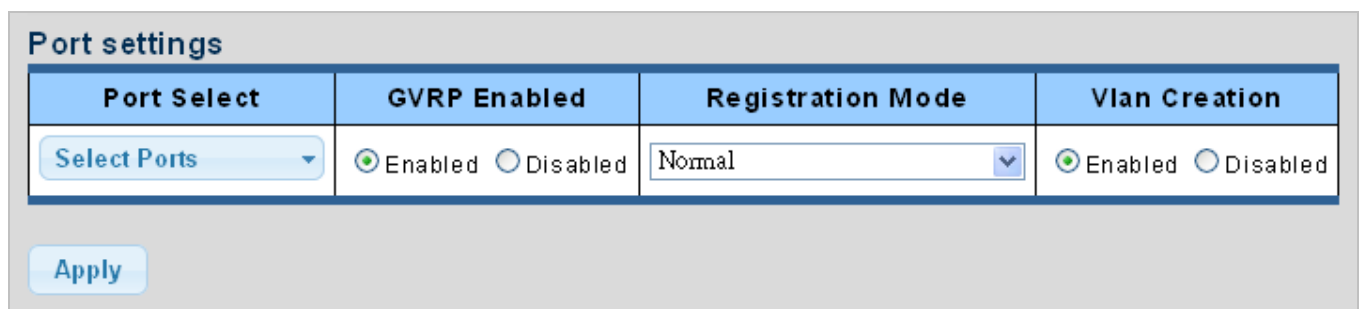

Figure 4-5-15 GVRP Global Setting Page Screenshot

The page includes the following fields:

Object	Description
• <b>Port Select</b>	Select port for this drop down list to assign protocol VLAN port
• <b>GVRP Enabled</b>	Controls whether GVRP is enabled or disabled on port
• <b>Registration Mode</b>	By default GVRP ports are in <b>normal</b> registration mode. These ports use GVRP join messages from neighboring switches to prune the VLANs running across the 802.1Q trunk link. If the device on the other side is not capable of sending GVRP messages, or if you do not want to allow the switch to prune any of the VLANs, use the <b>fixed</b> mode. Fixed mode ports will forward for all VLANs that exist in the switch database. Ports in <b>forbidden</b> mode forward only for VLAN 1.
• <b>VLAN Creation</b>	GVRP can dynamically create VLANs on switches for trunking purposes. By enabling GVRP dynamic VLAN creation, a switch will add VLANs to its database when it receives GVRP join messages about VLANs it does not have.

#### Buttons

: Click to apply changes.

GVRP Port Status			
Port	Enable State	Registration Mode	Vlan Creation State
GE1	Disabled	Normal	Enabled
GE2	Disabled	Normal	Enabled
GE3	Disabled	Normal	Enabled
GE4	Disabled	Normal	Enabled
LAG7	Disabled	Normal	Enabled
LAG8	Disabled	Normal	Enabled

Figure 4-5-16 GVRP Port Status Page Screenshot

The page includes the following fields:

Object	Description
• Port	The switch port number of the logical port
• Enable Status	Displays the current GVRP port state
• Registration Mode	Displays the current registration mode
• VLAN Creation Status	Displays the current VLAN creation status

### 4.5.12 GVRP VLAN

The GVRP VLAN Database screen in [Figure 4-5-17](#) appears.

GVRP VLAN Database			
VLAN ID	Member Ports	Dynamic Ports	VLAN Type

Figure 4-5-17 GVRP VLAN Database Status Page Screenshot

The page includes the following fields:

Object	Description
• VLAN ID	Displays the current VLAN ID
• Member Ports	Displays the current member ports
• Dynamic Ports	Displays the current dynamic ports
• VLAN Type	Displays the current VLAN type

### 4.5.13 GVRP Statistics

The GVRP Port Statistics and Error Statistics screens in [Figure 4-5-18](#) & [Figure 4-5-19](#) appear.

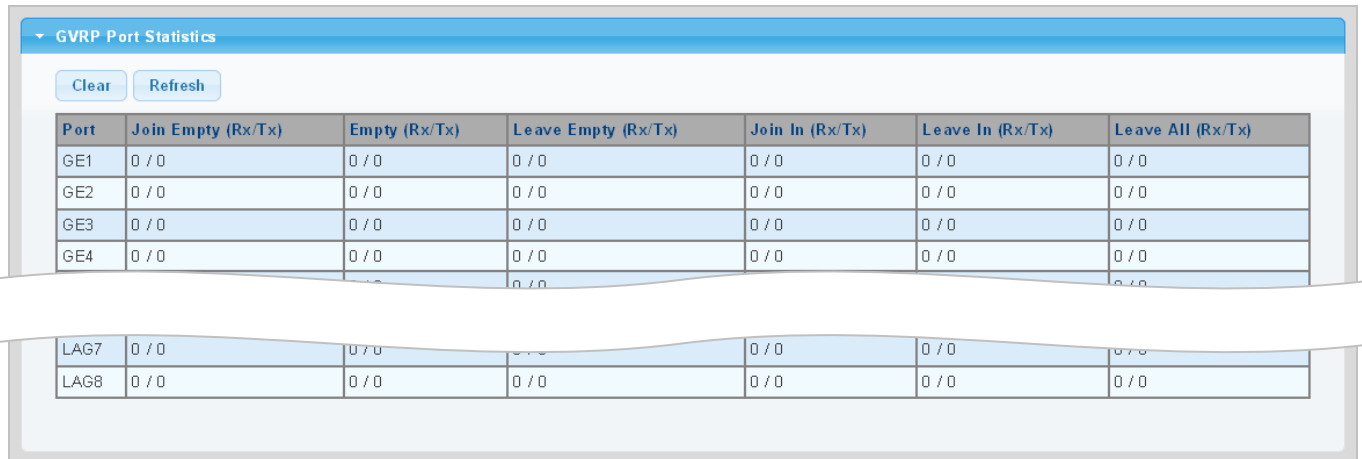

Port	Join Empty (Rx/Tx)	Empty (Rx/Tx)	Leave Empty (Rx/Tx)	Join In (Rx/Tx)	Leave In (Rx/Tx)	Leave All (Rx/Tx)
GE1	0 / 0	0 / 0	0 / 0	0 / 0	0 / 0	0 / 0
GE2	0 / 0	0 / 0	0 / 0	0 / 0	0 / 0	0 / 0
GE3	0 / 0	0 / 0	0 / 0	0 / 0	0 / 0	0 / 0
GE4	0 / 0	0 / 0	0 / 0	0 / 0	0 / 0	0 / 0
LAG7	0 / 0	0 / 0	0 / 0	0 / 0	0 / 0	0 / 0
LAG8	0 / 0	0 / 0	0 / 0	0 / 0	0 / 0	0 / 0

Figure 4-5-18 GVRP Port Statistics Page Screenshot

The page includes the following fields:

Object	Description
• Port	The switch port number of the logical port
• Join Empty (Rx/Tx)	Displays the current join empty (TX/RX) packets
• Empty (Rx/Tx)	Displays the current empty (TX/RX) packets
• Leave Empty (Rx/Tx)	Displays the current leave empty (TX/RX) packets
• Join In (Rx/Tx)	Displays the current join in (TX/RX) packets
• Leave In (Rx/Tx)	Displays the current leave in (TX/RX) packets
• LeaveAll (Rx/Tx)	Displays the current leaveall (TX/RX) packets

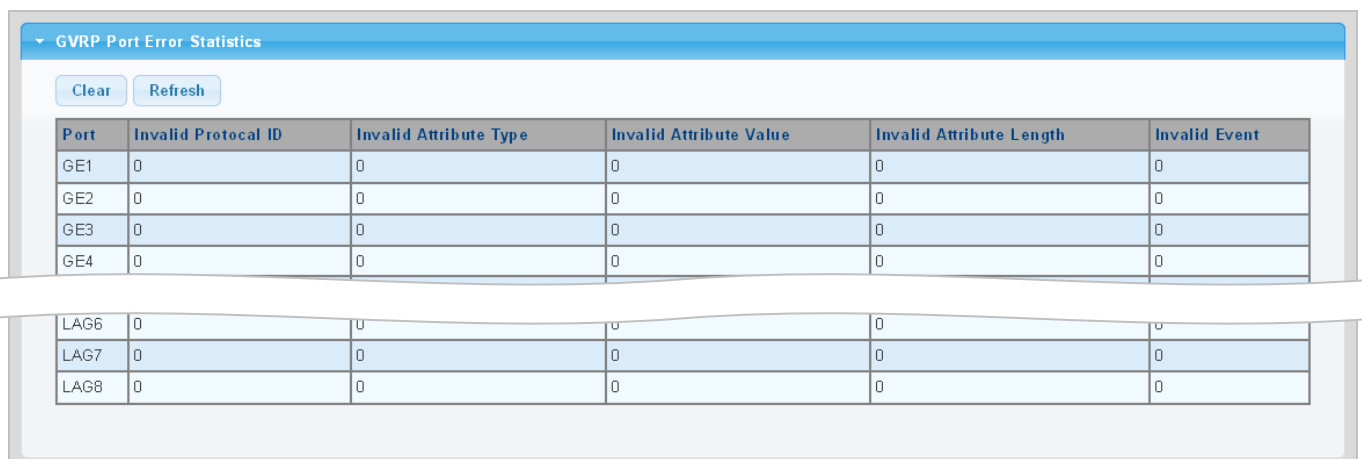

Port	Invalid Protocol ID	Invalid Attribute Type	Invalid Attribute Value	Invalid Attribute Length	Invalid Event
GE1	0	0	0	0	0
GE2	0	0	0	0	0
GE3	0	0	0	0	0
GE4	0	0	0	0	0
LAG6	0	0	0	0	0
LAG7	0	0	0	0	0
LAG8	0	0	0	0	0

Figure 4-5-19 GVRP Port Error Statistics Page Screenshot

The page includes the following fields:

Object	Description
• Port	The switch port number of the logical port.
• Invalid Protocol ID	Displays the current invalid protocol ID
• Invalid Attribute Type	Displays the current invalid attribute type
• Invalid Attribute Value	Displays the current invalid attribute value
• Invalid Attribute Length	Displays the current invalid attribute length
• Invalid Event	Displays the current invalid event.

**Buttons**

**Clear** : Click to clear the GVRP Error Statistics.

**Refresh** : Click to refresh the GVRP Error Statistics.

#### 4.5.14 VLAN Setting Example:

- Separate VLANs
- 802.1Q VLAN Trunk

##### 4.5.14.1 Two Separate 802.1Q VLANs

The diagram shows how the Industrial Managed Switch handles Tagged and Untagged traffic flow for two VLANs. VLAN Group 2 and VLAN Group 3 are separated VLANs. Each VLAN isolates network traffic so only members of the VLAN receive traffic from the same VLAN members. The screen in [Figure 4-5-20](#) appears and [Table 4-5-2](#) describes the port configuration of the Industrial Managed Switches.

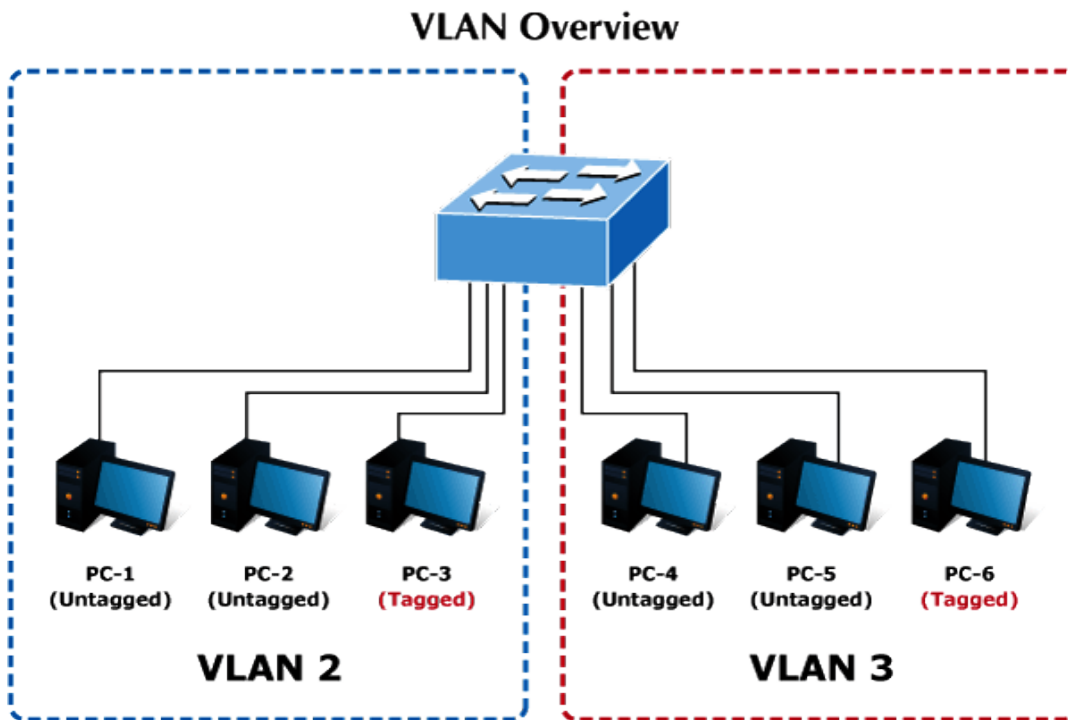

Figure 4-5-20 Two Separate VLAN Diagrams

VLAN Group	VID	Untagged Members	Tagged Members
VLAN Group 1	1	Port-7~Port-8	N/A
VLAN Group 2	2	Port-1,Port-2	Port-3
VLAN Group 3	3	Port-4,Port-5	Port-6

Table 4-5-2 VLAN and Port Configuration

The scenario described as follows:

■ **Untagged packet entering VLAN 2**

1. While [PC-1] transmits an **untagged** packet entering **Port-1**, the Industrial Managed Switch will tag it with a **VLAN Tag=2**. [PC-2] and [PC-3] will receive the packet through **Port-2** and **Port-3**.
2. [PC-4], [PC-5] and [PC-6] receive no packet.

3. While the packet leaves **Port-2**, it will be stripped away its tag becoming an **untagged** packet.
4. While the packet leaves **Port-3**, it will keep as a **tagged** packet with **VLAN Tag=2**.

### ■ Tagged packet entering VLAN 2

1. While **[PC-3]** transmits a **tagged** packet with **VLAN Tag=2** entering **Port-3**. **[PC-1]** and **[PC-2]** will receive the packet through **Port-1** and **Port-2**.
2. While the packet leaves **Port-1** and **Port-2**, it will be stripped away its tag becoming an **untagged** packet.

### ■ Untagged packet entering VLAN 3

1. While **[PC-4]** transmits an **untagged** packet entering **Port-4**, the switch will tag it with a **VLAN Tag=3**. **[PC-5]** and **[PC-6]** will receive the packet through **Port-5** and **Port-6**.
2. While the packet leaves **Port-5**, it will be stripped away its tag becoming an **untagged** packet.
3. While the packet leaves **Port-6**, it will keep as a **tagged** packet with **VLAN Tag=3**.



In this example, VLAN Group 1 is set as default VLAN, but only focuses on VLAN 2 and VLAN 3 traffic flow.

## Setup Steps

### 1. Create VLAN Group 2 and 3

Add VLAN group 2 and group 3

VLAN Table		
VLAN ID	VLAN Name	VLAN Type
1	default	Default
2	20002	Static
3	30003	Static

### 2. Assign VLAN mode and PVID to each port:

Port-1,Port-2 and Port-3 : VLAN Mode = Hybrid, PVID=2

Port-4,Port-5 and Port-6 : VLAN Mode = Hybrid, PVID=3

Port VLAN Status			
Port	Interface VLAN Mode	PVID	Accept Frame Type
GE1	Hybrid	2	ALL
GE2	Hybrid	2	ALL
GE3	Hybrid	2	ALL
GE4	Hybrid	3	ALL
GE5	Hybrid	3	ALL
GE6	Hybrid	3	ALL

**3. Assign Tagged/Untagged to each port:**

VLAN ID = 2:

Port-1 & 2 = Untagged,

Port-3 = Tagged,

Port -4~6 = Excluded.

Port to VLAN Settings			
VLAN ID : 2			
Port	Interface VLAN Mode	Membership	PVID
GE1	Hybrid	<input type="radio"/> Forbidden <input type="radio"/> Excluded <input type="radio"/> Tagged <input checked="" type="radio"/> Untagged	<input checked="" type="checkbox"/>
GE2	Hybrid	<input type="radio"/> Forbidden <input type="radio"/> Excluded <input type="radio"/> Tagged <input checked="" type="radio"/> Untagged	<input checked="" type="checkbox"/>
GE3	Hybrid	<input type="radio"/> Forbidden <input type="radio"/> Excluded <input checked="" type="radio"/> Tagged <input type="radio"/> Untagged	<input checked="" type="checkbox"/>
GE4	Hybrid	<input type="radio"/> Forbidden <input checked="" type="radio"/> Excluded <input type="radio"/> Tagged <input type="radio"/> Untagged	<input type="checkbox"/>
GE5	Hybrid	<input type="radio"/> Forbidden <input checked="" type="radio"/> Excluded <input type="radio"/> Tagged <input type="radio"/> Untagged	<input type="checkbox"/>
GE6	Hybrid	<input type="radio"/> Forbidden <input checked="" type="radio"/> Excluded <input type="radio"/> Tagged <input type="radio"/> Untagged	<input type="checkbox"/>

VLAN ID = 3:

Port-4 & 5 = Untagged,

Port -6 = Tagged,

Port-1~3 = Excluded.

Port to VLAN Settings			
VLAN ID : 3			
Port	Interface VLAN Mode	Membership	PVID
GE1	Hybrid	<input type="radio"/> Forbidden <input checked="" type="radio"/> Excluded <input type="radio"/> Tagged <input type="radio"/> Untagged	<input type="checkbox"/>
GE2	Hybrid	<input type="radio"/> Forbidden <input checked="" type="radio"/> Excluded <input type="radio"/> Tagged <input type="radio"/> Untagged	<input type="checkbox"/>
GE3	Hybrid	<input type="radio"/> Forbidden <input checked="" type="radio"/> Excluded <input type="radio"/> Tagged <input type="radio"/> Untagged	<input type="checkbox"/>
GE4	Hybrid	<input type="radio"/> Forbidden <input type="radio"/> Excluded <input type="radio"/> Tagged <input checked="" type="radio"/> Untagged	<input checked="" type="checkbox"/>
GE5	Hybrid	<input type="radio"/> Forbidden <input type="radio"/> Excluded <input type="radio"/> Tagged <input checked="" type="radio"/> Untagged	<input checked="" type="checkbox"/>
GE6	Hybrid	<input type="radio"/> Forbidden <input type="radio"/> Excluded <input checked="" type="radio"/> Tagged <input type="radio"/> Untagged	<input checked="" type="checkbox"/>

#### 4.5.14.2 VLAN Trunking between two 802.1Q aware switches

In most cases, they are used for “Uplink” to other switches. VLANs are separated at different switches, but they need to access other switches within the same VLAN group. The screen in [Figure 4-5-21](#) appears.

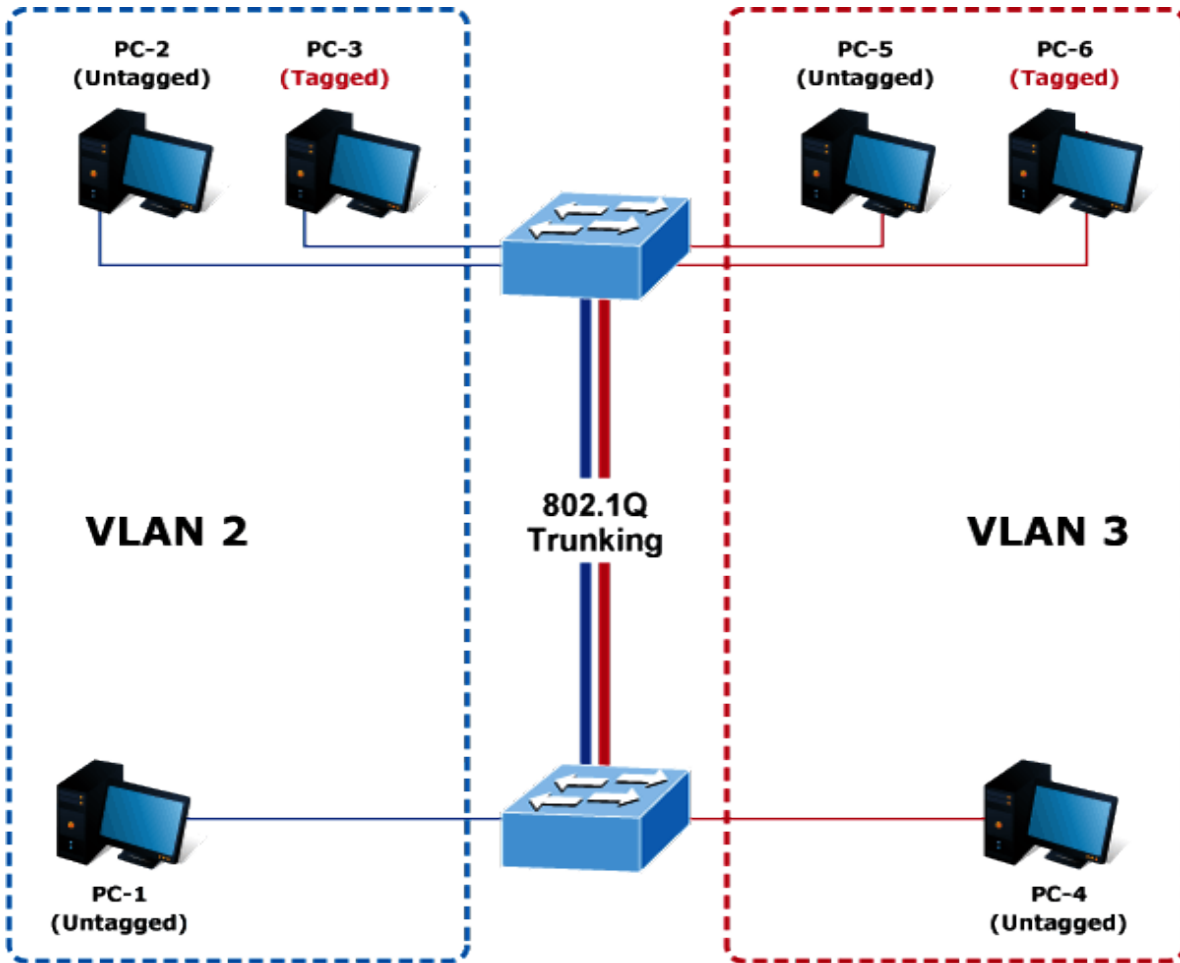

#### Setup steps

##### 1. Create VLAN Group 2 and 3

Add VLAN group 2 and group 3

VLAN Table		
VLAN ID	VLAN Name	VLAN Type
1	default	Default
2	20002	Static
3	30003	Static



**2. Assign VLAN mode and PVID to each port:**

Port-1,Port-2 and Port-3 : VLAN Mode = Hybrid, PVID=2  
 Port-4,Port-5 and Port-6 : VLAN Mode = Hybrid, PVID=3  
 Port-7 : VLAN Mode = Hybrid, PVID=1

Port VLAN Status			
Port	Interface VLAN Mode	PVID	Accept Frame Type
GE1	Hybrid	2	ALL
GE2	Hybrid	2	ALL
GE3	Hybrid	2	ALL
GE4	Hybrid	3	ALL
GE5	Hybrid	3	ALL
GE6	Hybrid	3	ALL
GE7	Hybrid	1	ALL

**3. Assign Tagged/Untagged to each port:**

VLAN ID = 1:  
 Port-1~6 = Untagged,  
 Port -7 = Excluded.

Port to VLAN Settings			
VLAN ID: 1			
Port	Interface VLAN Mode	Membership	PVID
GE1	Hybrid	<input type="radio"/> Forbidden <input type="radio"/> Excluded <input type="radio"/> Tagged <input checked="" type="radio"/> Untagged	<input type="checkbox"/>
GE2	Hybrid	<input type="radio"/> Forbidden <input type="radio"/> Excluded <input type="radio"/> Tagged <input checked="" type="radio"/> Untagged	<input type="checkbox"/>
GE3	Hybrid	<input type="radio"/> Forbidden <input type="radio"/> Excluded <input type="radio"/> Tagged <input checked="" type="radio"/> Untagged	<input type="checkbox"/>
GE4	Hybrid	<input type="radio"/> Forbidden <input type="radio"/> Excluded <input type="radio"/> Tagged <input checked="" type="radio"/> Untagged	<input type="checkbox"/>
GE5	Hybrid	<input type="radio"/> Forbidden <input type="radio"/> Excluded <input type="radio"/> Tagged <input checked="" type="radio"/> Untagged	<input type="checkbox"/>
GE6	Hybrid	<input type="radio"/> Forbidden <input type="radio"/> Excluded <input type="radio"/> Tagged <input checked="" type="radio"/> Untagged	<input type="checkbox"/>
GE7	Hybrid	<input type="radio"/> Forbidden <input type="radio"/> Excluded <input checked="" type="radio"/> Tagged <input type="radio"/> Untagged	<input checked="" type="checkbox"/>

VLAN ID = 2:  
 Port-1 & 2 = Untagged,  
 Port-3 & 7 = Tagged,  
 Port -4~6 = Excluded.

Port to VLAN Settings

VLAN ID: 2

Port	Interface VLAN Mode	Membership	PVID
GE1	Hybrid	<input type="radio"/> Forbidden <input type="radio"/> Excluded <input type="radio"/> Tagged <input checked="" type="radio"/> Untagged	<input checked="" type="checkbox"/>
GE2	Hybrid	<input type="radio"/> Forbidden <input type="radio"/> Excluded <input type="radio"/> Tagged <input checked="" type="radio"/> Untagged	<input checked="" type="checkbox"/>
GE3	Hybrid	<input type="radio"/> Forbidden <input type="radio"/> Excluded <input checked="" type="radio"/> Tagged <input type="radio"/> Untagged	<input checked="" type="checkbox"/>
GE4	Hybrid	<input type="radio"/> Forbidden <input checked="" type="radio"/> Excluded <input type="radio"/> Tagged <input type="radio"/> Untagged	<input type="checkbox"/>
GE5	Hybrid	<input type="radio"/> Forbidden <input checked="" type="radio"/> Excluded <input type="radio"/> Tagged <input type="radio"/> Untagged	<input type="checkbox"/>
GE6	Hybrid	<input type="radio"/> Forbidden <input checked="" type="radio"/> Excluded <input type="radio"/> Tagged <input type="radio"/> Untagged	<input type="checkbox"/>
GE7	Hybrid	<input type="radio"/> Forbidden <input type="radio"/> Excluded <input checked="" type="radio"/> Tagged <input type="radio"/> Untagged	<input type="checkbox"/>

VLAN ID = 3:

Port-4 & 5 = Untagged,

Port -6 & 7= Tagged,

Port-1~3 = Excluded.

Port to VLAN Settings

VLAN ID: 3

Port	Interface VLAN Mode	Membership	PVID
GE1	Hybrid	<input type="radio"/> Forbidden <input checked="" type="radio"/> Excluded <input type="radio"/> Tagged <input type="radio"/> Untagged	<input type="checkbox"/>
GE2	Hybrid	<input type="radio"/> Forbidden <input checked="" type="radio"/> Excluded <input type="radio"/> Tagged <input type="radio"/> Untagged	<input type="checkbox"/>
GE3	Hybrid	<input type="radio"/> Forbidden <input checked="" type="radio"/> Excluded <input type="radio"/> Tagged <input type="radio"/> Untagged	<input type="checkbox"/>
GE4	Hybrid	<input type="radio"/> Forbidden <input type="radio"/> Excluded <input type="radio"/> Tagged <input checked="" type="radio"/> Untagged	<input checked="" type="checkbox"/>
GE5	Hybrid	<input type="radio"/> Forbidden <input type="radio"/> Excluded <input type="radio"/> Tagged <input checked="" type="radio"/> Untagged	<input checked="" type="checkbox"/>
GE6	Hybrid	<input type="radio"/> Forbidden <input type="radio"/> Excluded <input checked="" type="radio"/> Tagged <input type="radio"/> Untagged	<input checked="" type="checkbox"/>
GE7	Hybrid	<input type="radio"/> Forbidden <input type="radio"/> Excluded <input checked="" type="radio"/> Tagged <input type="radio"/> Untagged	<input type="checkbox"/>

## 4.6 Spanning Tree Protocol

### 4.6.1 Theory

The Spanning Tree Protocol can be used to detect and disable network loops, and to provide backup links between switches, bridges or routers. This allows the switch to interact with other bridging devices in your network to ensure that only one route exists between any two stations on the network, and provide backup links which automatically take over when a primary link goes down. The spanning tree algorithms supported by this switch include these versions:

- **STP – Spanning Tree Protocol (IEEE 802.1D)**
- **RSTP – Rapid Spanning Tree Protocol (IEEE 802.1w)**
- **MSTP – Multiple Spanning Tree Protocol (IEEE 802.1s)**

The **IEEE 802.1D Spanning Tree** Protocol and **IEEE 802.1w Rapid Spanning Tree** Protocol allow for the blocking of links between switches that form loops within the network. When multiple links between switches are detected, a primary link is established. Duplicated links are blocked from use and become standby links. The protocol allows for the duplicate links to be used in the event of a failure of the primary link. Once the Spanning Tree Protocol is configured and enabled, primary links are established and duplicated links are blocked automatically. The reactivation of the blocked links (at the time of a primary link failure) is also accomplished automatically without operator intervention.

This automatic network reconfiguration provides maximum uptime to network users. However, the concepts of the Spanning Tree Algorithm and protocol are a complicated and complex subject and must be fully researched and understood. It is possible to cause serious degradation of the performance of the network if the Spanning Tree is incorrectly configured. Please read the following before making any changes from the default values.

The Switch STP performs the following functions:

- Creates a single spanning tree from any combination of switching or bridging elements.
- Creates multiple spanning trees – from any combination of ports contained within a single switch, in user specified groups.
- Automatically reconfigures the spanning tree to compensate for the failure, addition, or removal of any element in the tree.
- Reconfigures the spanning tree without operator intervention.

#### Bridge Protocol Data Units

For STP to arrive at a stable network topology, the following information is used:

- The unique switch identifier
- The path cost to the root associated with each switch port
- The port identifier

STP communicates between switches on the network using Bridge Protocol Data Units (BPDUs). Each BPDU contains the following information:

- The unique identifier of the switch that the transmitting switch currently believes is the root switch
- The path cost to the root from the transmitting port

- The port identifier of the transmitting port

The switch sends BPDUs to communicate and construct the spanning-tree topology. All switches connected to the LAN on which the packet is transmitted will receive the BPDU. BPDUs are not directly forwarded by the switch, but the receiving switch uses the information in the frame to calculate a BPDU, and, if the topology changes, initiates a BPDU transmission.

The communication between switches via BPDUs results in the following:

- One switch is elected as the root switch
- The shortest distance to the root switch is calculated for each switch
- A designated switch is selected. This is the switch closest to the root switch through which packets will be forwarded to the root.
- A port for each switch is selected. This is the port providing the best path from the switch to the root switch.
- Ports included in the STP are selected.

### **Creating a Stable STP Topology**

It is to make the root port a fastest link. If all switches have STP enabled with default settings, the switch with the lowest MAC address in the network will become the root switch. By increasing the priority (lowering the priority number) of the best switch, STP can be forced to select the best switch as the root switch.

When STP is enabled using the default parameters, the path between source and destination stations in a switched network might not be ideal. For instance, connecting higher-speed links to a port that has a higher number than the current root port can cause a root-port change.

### **STP Port States**

The BPDUs take some time to pass through a network. This propagation delay can result in topology changes where a port that transitioned directly from a Blocking state to a Forwarding state could create temporary data loops. Ports must wait for new network topology information to propagate throughout the network before starting to forward packets. They must also wait for the packet lifetime to expire for BPDU packets that were forwarded based on the old topology. The forward delay timer is used to allow the network topology to stabilize after a topology change. In addition, STP specifies a series of states a port must transition through to further ensure that a stable network topology is created after a topology change.

**Each port on a switch using STP exists in one of the following five states:**

- **Blocking** – the port is blocked from forwarding or receiving packets
- **Listening** – the port is waiting to receive BPDU packets that may tell the port to go back to the blocking state
- **Learning** – the port is adding addresses to its forwarding database, but not yet forwarding packets
- **Forwarding** – the port is forwarding packets
- **Disabled** – the port only responds to network management messages and must return to the blocking state first

**A port transitions from one state to another as follows:**

- From initialization (switch boot) to blocking
- From blocking to listening or to disabled
- From listening to learning or to disabled
- From learning to forwarding or to disabled
- From forwarding to disabled

- From disabled to blocking

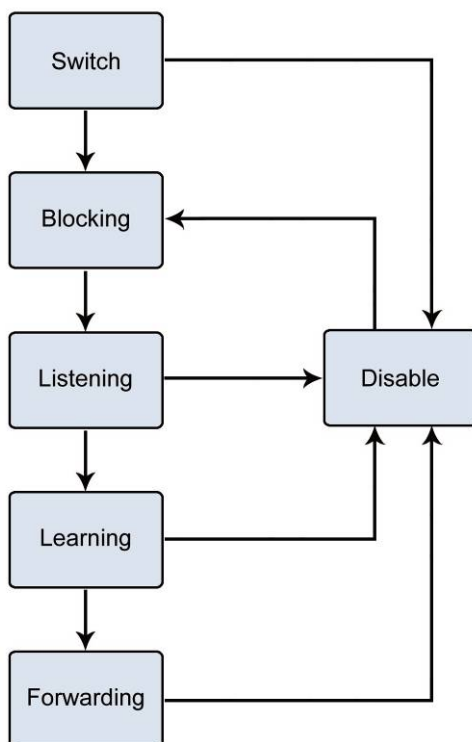



Figure 4-6-1 STP Port State Transitions

You can modify each port state by using management software. When you enable STP, every port on every switch in the network goes through the blocking state and then transitions through the states of listening and learning at power up. If properly configured, each port stabilizes to the forwarding or blocking state. No packets (except BPDUs) are forwarded from, or received by, STP enabled ports until the forwarding state is enabled for that port.

## 2. STP Parameters

### STP Operation Levels

The Switch allows for two levels of operation: the switch level and the port level. The switch level forms a spanning tree consisting of links between one or more switches. The port level constructs a spanning tree consisting of groups of one or more ports. The STP operates in much the same way for both levels.



On the switch level, STP calculates the Bridge Identifier for each switch and then sets the Root Bridge and the Designated Bridges. On the port level, STP sets the Root Port and the Designated Ports.

The following are the user-configurable STP parameters for the switch level:

Parameter	Description	Default Value
<b>Bridge Identifier(Not user configurable)</b>	A combination of the User-set priority and the switch's MAC address.	32768 + MAC

<b>except by setting priority below)</b>	The Bridge Identifier consists of two parts: a 16-bit priority and a 48-bit Ethernet MAC address 32768 + MAC	
<b>Priority</b>	A relative priority for each switch – lower numbers give a higher priority and a greater chance of a given switch being elected as the root bridge	32768
<b>Hello Time</b>	The length of time between broadcasts of the hello message by the switch	2 seconds
<b>Maximum Age Timer</b>	Measures the age of a received BPDU for a port and ensures that the BPDU is discarded when its age exceeds the value of the maximum age timer.	20 seconds
<b>Forward Delay Timer</b>	The amount time spent by a port in the learning and listening states waiting for a BPDU that may return the port to the blocking state.	15 seconds

The following are the user-configurable STP parameters for the port or port group level:

Variable	Description	Default Value
<b>Port Priority</b>	A relative priority for each port –lower numbers give a higher priority and a greater chance of a given port being elected as the root port	128
<b>Port Cost</b>	A value used by STP to evaluate paths – STP calculates path costs and selects the path with the minimum cost as the active path	200,000-100Mbps Fast Ethernet ports 20,000-1000Mbps Gigabit Ethernet ports 0 - Auto

### Default Spanning-Tree Configuration

Feature	Default Value
Enable state	STP disabled for all ports
Port priority	128
Port cost	0
Bridge Priority	32,768

### User-Changeable STA Parameters

The Switch's factory default setting should cover the majority of installations. However, it is advisable to keep the default settings as set at the factory; unless, it is absolutely necessary. The user changeable parameters in the Switch are as follows:

**Priority** – A Priority for the switch can be set from 0 to 65535. 0 is equal to the highest Priority.

**Hello Time** – The Hello Time can be from 1 to 10 seconds. This is the interval between two transmissions of BPDU packets sent by the Root Bridge to tell all other Switches that it is indeed the Root Bridge. If you set a Hello Time for your Switch, and it is not the Root Bridge, the set Hello Time will be used if and when your Switch becomes the Root Bridge.



The Hello Time cannot be longer than the Max. Age. Otherwise, a configuration error will occur.

**Max. Age** – The Max Age can be from 6 to 40 seconds. At the end of the Max Age, if a BPDU has still not been received from the Root Bridge, your Switch will start sending its own BPDU to all other Switches for permission to become the Root Bridge. If it turns out that your Switch has the lowest Bridge Identifier, it will become the Root Bridge.

**Forward Delay Timer** – The Forward Delay can be from 4 to 30 seconds. This is the time any port on the Switch spends in the listening state while moving from the blocking state to the forwarding state.



Observe the following formulas when setting the above parameters:

**Max. Age \_ 2 x (Forward Delay - 1 second)**

**Max. Age \_ 2 x (Hello Time + 1 second)**

**Port Priority** – A Port Priority can be from 0 to 240. The lower the number, the greater the probability the port will be chosen as the Root Port.

**Port Cost** – A Port Cost can be set from 0 to 200000000. The lower the number, the greater the probability the port will be chosen to forward packets.

### 3. Illustration of STP

A simple illustration of three switches connected in a loop is depicted in the below diagram. In this example, you can anticipate some major network problems if the STP assistance is not applied.

If switch A broadcasts a packet to switch B, switch B will broadcast it to switch C, and switch C will broadcast it to back to switch A and so on. The broadcast packet will be passed indefinitely in a loop, potentially causing a network failure. In this example, STP breaks the loop by blocking the connection between switch B and C. The decision to block a particular connection is based on the STP calculation of the most current Bridge and Port settings.

Now, if switch A broadcasts a packet to switch C, then switch C will drop the packet at port 2 and the broadcast will end there. Setting-up STP using values other than the defaults, can be complex. Therefore, you are advised to keep the default factory settings and STP will automatically assign root bridges/ports and block loop connections. Influencing STP to choose a particular switch as the root bridge using the Priority setting, or influencing STP to choose a particular port to block using the Port Priority and Port Cost settings is, however, relatively straight forward.

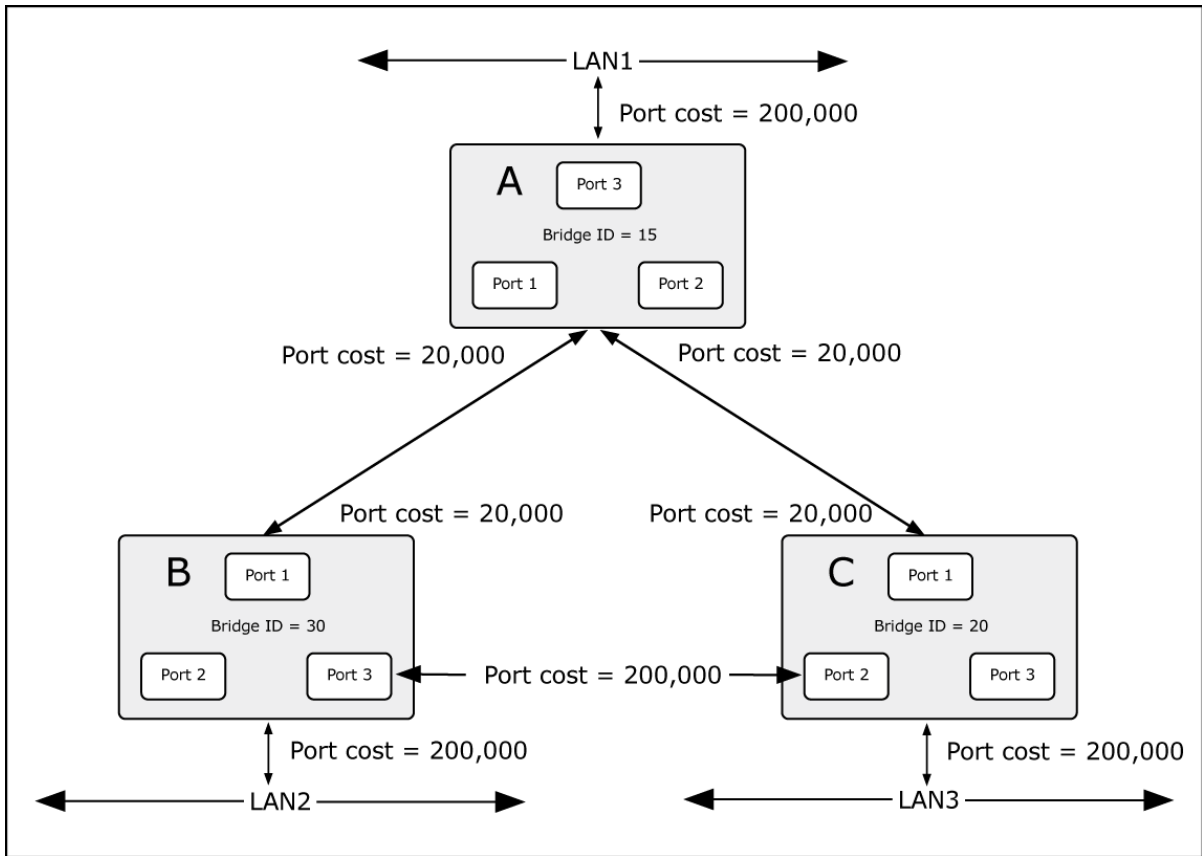

**Figure 4-6-2** Before Applying the STA Rules

In this example, only the default STP values are used.

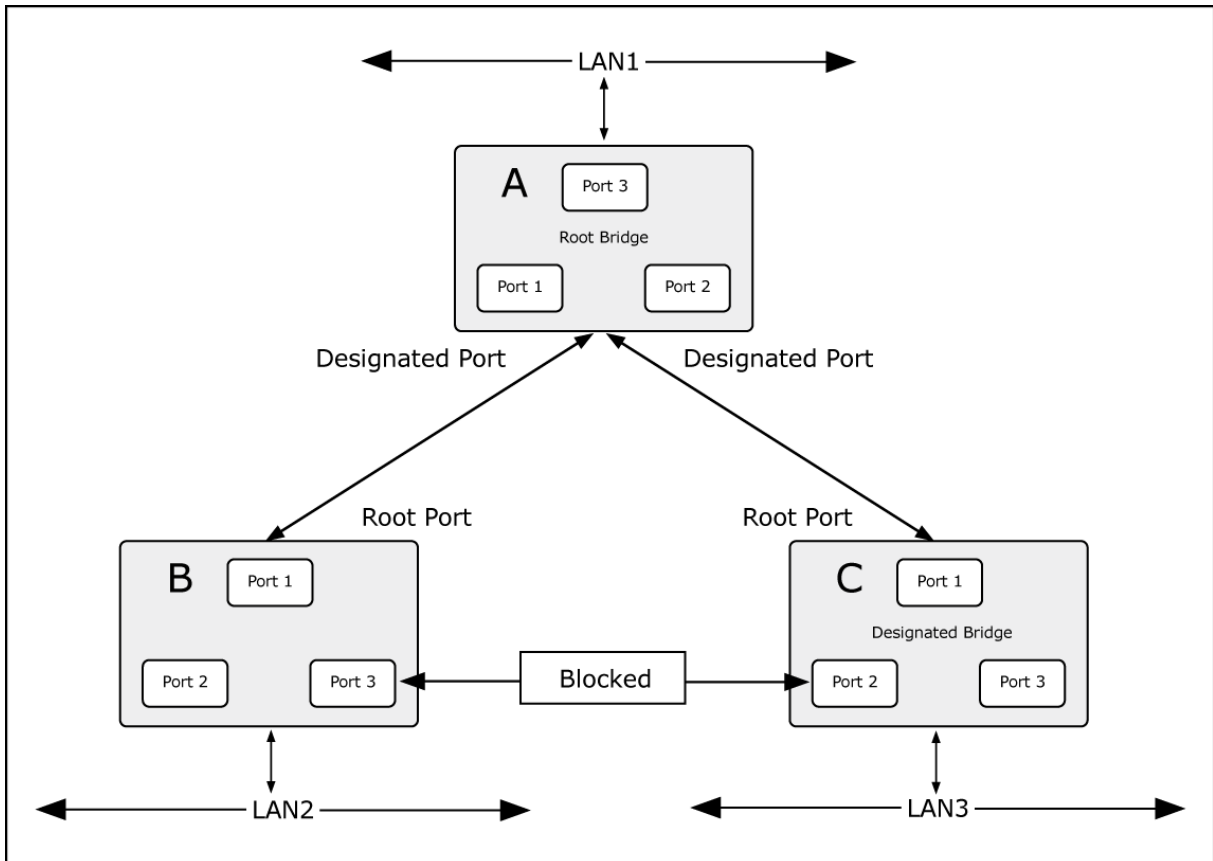

**Figure 4-6-3** After Applying the STA Rules



The switch with the lowest Bridge ID (switch C) was elected the root bridge, and the ports were selected to give a high port cost between switches B and C. The two (optional) Gigabit ports (default port cost = 20,000) on switch A are connected to one (optional) Gigabit port on both switch B and C. The redundant link between switch B and C is deliberately chosen as a 100 Mbps Fast Ethernet link (default port cost = 200,000). Gigabit ports could be used, but the port cost should be increased from the default to ensure that the link between switch B and switch C is the blocked link.

This section has the following items:

- **STP Global Setting**                      Configures STP system settings
- **STP Port Setting**                        Configuration per port STP setting
- **CIST Instance Setting**                  Configures system configuration
- **CIST Port Setting**                        Configures CIST port setting
- **MST Instance Setting**                  Configuration each MST instance setting
- **MST Port Setting**                        Configuration per port MST setting
- **STP Statistics**                            Displays the STP statistics

### 4.6.2 STP Global Settings

This page allows you to configure STP system settings. The settings are used by all STP Bridge instances in the Switch. The Industrial Managed Switch support the following Spanning Tree protocols:

- **Compatible -- Spanning Tree Protocol (STP):** Provides a single path between end stations, avoiding and eliminating loops.
- **Normal -- Rapid Spanning Tree Protocol (RSTP):** Detects and uses of network topologies that provide faster spanning tree convergence, without creating forwarding loops.
- **Extension – Multiple Spanning Tree Protocol (MSTP):** Defines an extension to RSTP to further develop the usefulness of virtual LANs (VLANs). This "Per-VLAN" Multiple Spanning Tree Protocol configures a separate Spanning Tree for each VLAN group and blocks all but one of the possible alternate paths within each Spanning Tree.

The STP Global Settings screens in [Figure 4-6-4](#) & [Figure 4-6-5](#) appear.

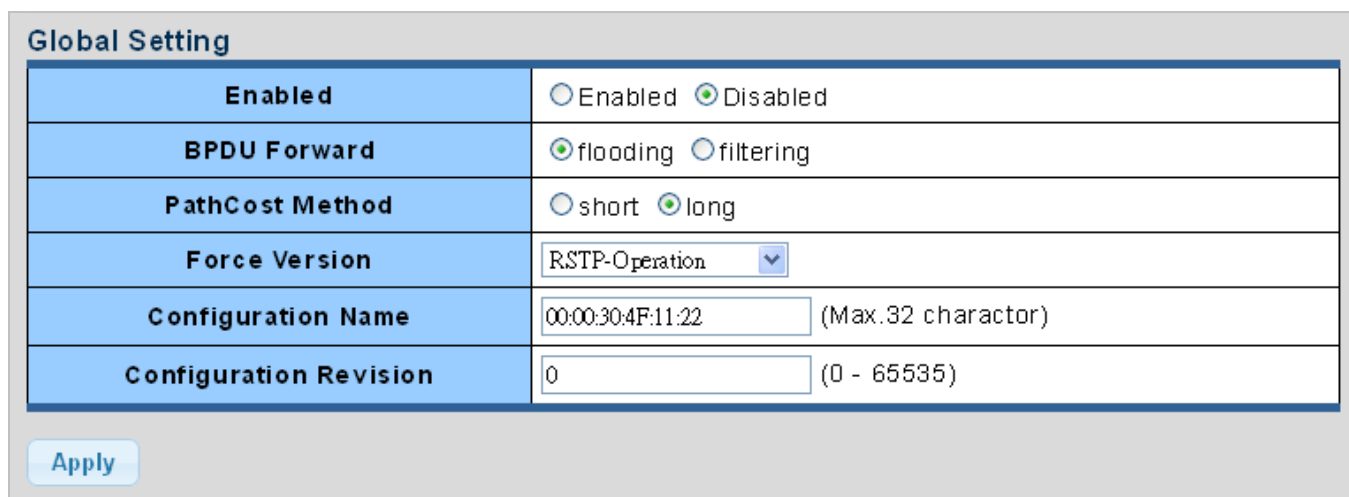

Global Setting	
<b>Enabled</b>	<input type="radio"/> Enabled <input checked="" type="radio"/> Disabled
<b>BPDU Forward</b>	<input checked="" type="radio"/> flooding <input type="radio"/> filtering
<b>PathCost Method</b>	<input type="radio"/> short <input checked="" type="radio"/> long
<b>Force Version</b>	RSTP-Operation <input type="button" value="v"/>
<b>Configuration Name</b>	00:00:30:4F:11:22 (Max.32 charactor)
<b>Configuration Revision</b>	0 (0 - 65535)

Figure 4-6-4 Global Settings Page Screenshot

The page includes the following fields:

Object	Description
• <b>Enable</b>	Enable or disable the STP function.  The default value is "Disabled".
• <b>BPDU Forward</b>	Set the BPDU forward method.
• <b>PathCost Method</b>	The path cost method is used to determine the best path between devices. Therefore, lower values should be assigned to ports attached to faster media, and higher values assigned to ports with slower media.
• <b>Force Version</b>	The STP protocol version setting. Valid values are <b>STP-Compatible</b> , <b>RSTP-Operation</b> and <b>MSTP-Operation</b> .

• <b>Configuration Name</b>	Identifier used to identify the configuration currently being used.
• <b>Configuration Revision</b>	Identifier used to identify the configuration currently being used.  The values allowed are between 0 and 65535.  The default value is <b>0</b> .

**Buttons**

: Click to apply changes.

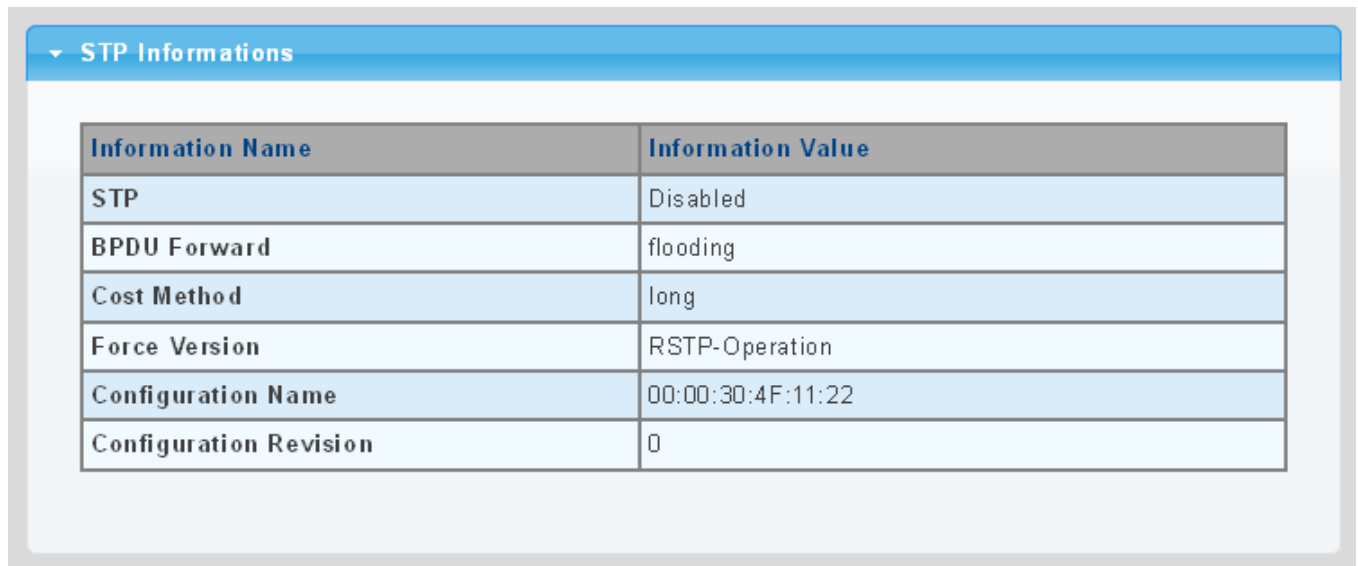

The screenshot shows a web interface with a blue header bar containing a dropdown arrow and the text "STP Informations". Below the header is a table with two columns: "Information Name" and "Information Value".

Information Name	Information Value
STP	Disabled
BPDU Forward	flooding
Cost Method	long
Force Version	RSTP-Operation
Configuration Name	00:00:30:4F:11:22
Configuration Revision	0

**Figure 4-6-5** STP Information Page Screenshot

The page includes the following fields:

Object	Description
• <b>STP</b>	Displays the current STP state
• <b>BPDU Forward</b>	Displays the current BPDU forward mode
• <b>Cost Method</b>	Displays the current cost method
• <b>Force Version</b>	Displays the current force version
• <b>Configuration Name</b>	Displays the current configuration name
• <b>Configuration Revision</b>	Display the current configuration revision

### 4.6.3 STP Port Setting

This page allows you to configure per port STP settings. The STP Port Setting screens in [Figure 4-6-6](#) & [Figure 4-6-7](#) appear.

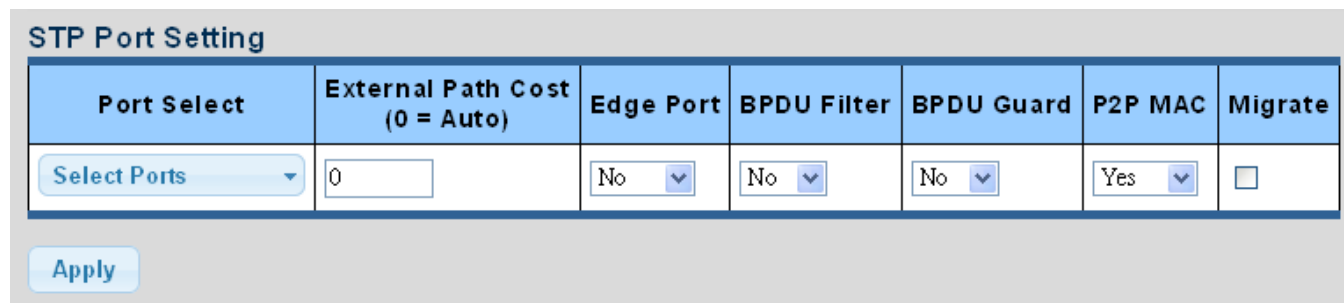

Port Select	External Path Cost (0 = Auto)	Edge Port	BPDU Filter	BPDU Guard	P2P MAC	Migrate
Select Ports	0	No	No	No	Yes	<input type="checkbox"/>

Apply

Figure 4-6-6 STP Port Configuration Page Screenshot

The page includes the following fields:

Object	Description
<ul style="list-style-type: none"> <li>• <b>Port Select</b></li> </ul>	Select port number for this drop down list.
<ul style="list-style-type: none"> <li>• <b>External Cost (0 = Auto)</b></li> </ul>	<p>Controls the path cost incurred by the port.</p> <p>The Auto setting will set the path cost as appropriate by the physical link speed, using the 802.1D recommended values. Using the Specific setting, a user-defined value can be entered.</p> <p>The path cost is used when establishing the active topology of the network. Lower path cost ports are chosen as forwarding ports in favor of higher path cost ports. Valid values are in the range 1 to 200000000.</p>
<ul style="list-style-type: none"> <li>• <b>Edge Port</b></li> </ul>	Controls whether the operEdge flag should start as being set or cleared. (The initial operEdge state when a port is initialized).
<ul style="list-style-type: none"> <li>• <b>BPDU Filter</b></li> </ul>	Control whether a port explicitly configured as Edge will transmit and receive BPDUs.
<ul style="list-style-type: none"> <li>• <b>BPDU Guard</b></li> </ul>	<p>Control whether a port explicitly configured as Edge will disable itself upon reception of a BPDU.</p> <p>The port will enter the error-disabled state, and will be removed from the active topology.</p>
<ul style="list-style-type: none"> <li>• <b>P2P MAC</b></li> </ul>	<p>Controls whether the port connects to a point-to-point LAN rather than a shared medium.</p> <p>This can be automatically determined, or forced either true or false. Transition to the forwarding state is faster for point-to-point LANs than for shared media. (This applies to physical ports only. Aggregations are always <i>forced Point2Point</i>).</p>
<ul style="list-style-type: none"> <li>• <b>Migrate</b></li> </ul>	<p>If at any time the switch detects STP BPDUs, including Configuration or <b>Topology Change Notification</b> BPDUs, it will automatically set the selected interface to forced STP-compatible mode.</p> <p>However, you can also use the Protocol Migration button to manually re-check</p>

	<p>the appropriate BPDU format (RSTP or STP-compatible) to send on the selected interfaces.</p> <p>(Default: <b>Disabled</b>)</p>
--	---

**Buttons**



: Click to apply changes.

By default, the system automatically detects the speed and duplex mode used on each port, and configures the path cost according to the values shown below. Path cost "0" is used to indicate auto-configuration mode. When the short path cost method is selected and the default path cost recommended by the IEEE 8021w standard exceeds 65,535, the default is set to 65,535.

Port Type	IEEE 802.1D-1998	IEEE 802.1w-2001
<b>Ethernet</b>	50-600	200,000-20,000,000
<b>Fast Ethernet</b>	10-60	20,000-2,000,000
<b>Gigabit Ethernet</b>	3-10	2,000-200,000

**Table 4-6-1** Recommended STP Path Cost Range

Port Type	Link Type	IEEE 802.1D-1998	IEEE 802.1w-2001
<b>Ethernet</b>	Half Duplex	100	2,000,000
	Full Duplex	95	1,999,999
	Trunk	90	1,000,000
<b>Fast Ethernet</b>	Half Duplex	19	200,000
	Full Duplex	18	100,000
	Trunk	15	50,000
<b>Gigabit Ethernet</b>	Full Duplex	4	10,000
	Trunk	3	5,000

**Table 4-6-2** Recommended STP Path Costs

Port Type	Link Type	IEEE 802.1w-2001
<b>Ethernet</b>	Half Duplex	2,000,000
	Full Duplex	1,000,000
	Trunk	500,000
<b>Fast Ethernet</b>	Half Duplex	200,000
	Full Duplex	100,000
	Trunk	50,000
<b>Gigabit Ethernet</b>	Full Duplex	10,000
	Trunk	5,000

**Table 4-6-3** Default STP Path Costs

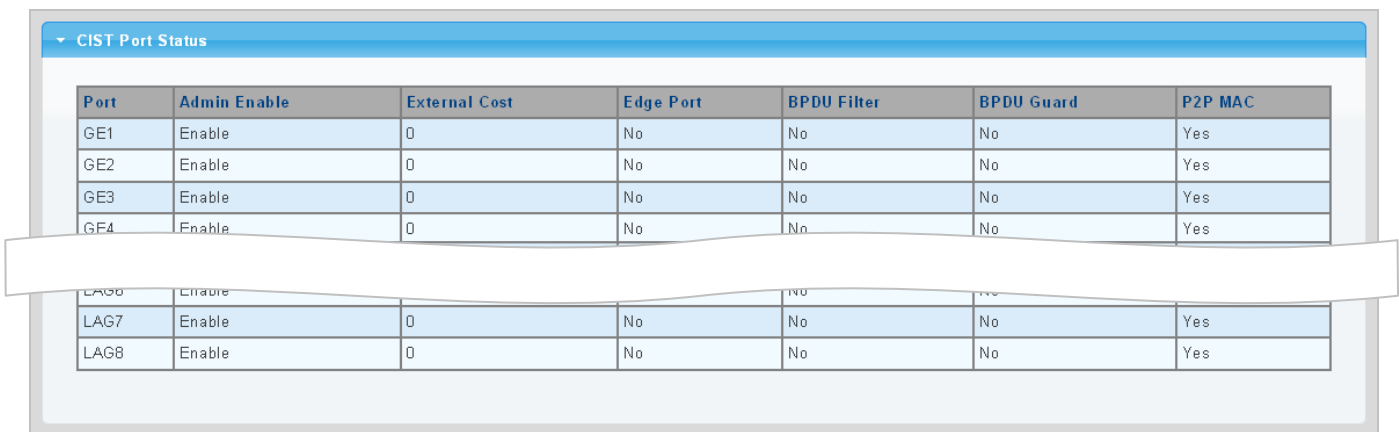

Port	Admin Enable	External Cost	Edge Port	BPDU Filter	BPDU Guard	P2P MAC
GE1	Enable	0	No	No	No	Yes
GE2	Enable	0	No	No	No	Yes
GE3	Enable	0	No	No	No	Yes
GE4	Enable	0	No	No	No	Yes
LAG6	Enable	0	No	No	No	Yes
LAG7	Enable	0	No	No	No	Yes
LAG8	Enable	0	No	No	No	Yes

Figure 4-6-7 STP Port Status Page Screenshot

The page includes the following fields:

Object	Description
• <b>Port</b>	The switch port number of the logical STP port.
• <b>Admin Enable</b>	Displays the current STP port mode status
• <b>External Cost</b>	Displays the current external cost.
• <b>Edge Port</b>	Displays the current edge port status.
• <b>BPDU Filter</b>	Displays the current BPDU filter configuration.
• <b>BPDU Guard</b>	Displays the current BPDU guard configuration.
• <b>P2P MAC</b>	Displays the current P2P MAC status.

### 4.6.4 CIST Instance Setting

This page allows you to configure CIST instance settings. The CIST Instance Setting and Information screens in [Figure 4-6-8](#) & [Figure 4-6-9](#) appear.

**CIST Instance Setting**

<b>Priority</b>	<input type="text" value="32768"/> <span style="float: right;">▼</span>
<b>Max Hops</b>	<input type="text" value="20"/> (1-40)
<b>Forward Delay</b>	<input type="text" value="15"/> (4-30)
<b>Max Age</b>	<input type="text" value="20"/> (6-40)
<b>Tx Hold Count</b>	<input type="text" value="6"/> (1-10)
<b>Hello Time</b>	<input type="text" value="2"/> (1-10)

**Figure 4-6-8:** CIST Instance Setting Page Screenshot

The page includes the following fields:

Object	Description
<ul style="list-style-type: none"> <li><b>priority</b></li> </ul>	<p>Controls the bridge priority. Lower numeric values have better priority. The bridge priority plus the MSTI instance number, concatenated with the 6-byte MAC address of the switch forms a Bridge Identifier.</p> <p>For MSTP operation, this is the priority of the CIST. Otherwise, this is the priority of the STP/RSTP bridge.</p>
<ul style="list-style-type: none"> <li><b>Max Hops</b></li> </ul>	<p>This defines the initial value of remaining Hops for MSTI information generated at the boundary of an MSTI region. It defines how many bridges a root bridge can distribute its BPDU information. Valid values are in the range 6 to 40 hops.</p>
<ul style="list-style-type: none"> <li><b>Forward Delay</b></li> </ul>	<p>The delay used by STP Bridges to transition Root and Designated Ports to Forwarding (used in STP compatible mode). Valid values are in the range 4 to 30 seconds</p> <p>-Default: 15</p> <p>-Minimum: <a href="#">The higher of 4 or [(Max. Message Age / 2) + 1]</a></p> <p>-Maximum: 30</p>
<ul style="list-style-type: none"> <li><b>Max Age</b></li> </ul>	<p>The maximum age of the information transmitted by the Bridge when it is the Root Bridge. Valid values are in the range 6 to 40 seconds.</p> <p>-Default: 20</p> <p>-Minimum: <a href="#">The higher of 6 or [2 x (Hello Time + 1)]</a>.</p> <p>-Maximum: <a href="#">The lower of 40 or [2 x (Forward Delay - 1)]</a></p>

<ul style="list-style-type: none"> <li>• <b>Tx Hold Count</b></li> </ul>	<p>The number of BPDU's a bridge port can send per second.</p> <p>When exceeded, transmission of the next BPDU will be delayed. Valid values are in the range 1 to 10 BPDU's per second.</p>
<ul style="list-style-type: none"> <li>• <b>Hello Time</b></li> </ul>	<p>The time that controls the switch to send out the BPDU packet to check STP current status.</p> <p>Enter a value between 1 through 10.</p>

**Buttons**



: Click to apply changes.

▼ CIST Instance Information

Information Name	Information Value
Priority	32768
Max Hops	20
Forward Delay	15
Max Age	20
Tx Hold Count	6
Hello Time	2

**Figure 4-6-9** CIST Instance Information Page Screenshot

The page includes the following fields:

Object	Description
<ul style="list-style-type: none"> <li>• <b>Priority</b></li> </ul>	Displays the current CIST priority
<ul style="list-style-type: none"> <li>• <b>Max Hop</b></li> </ul>	Displays the current Max. hop
<ul style="list-style-type: none"> <li>• <b>Forward Delay</b></li> </ul>	Displays the current forward delay
<ul style="list-style-type: none"> <li>• <b>Max Age</b></li> </ul>	Displays the current Max.Age
<ul style="list-style-type: none"> <li>• <b>Tx Hold Count</b></li> </ul>	Displays the current Tx hold count
<ul style="list-style-type: none"> <li>• <b>Hello Time</b></li> </ul>	Displays the current hello time



### 4.6.5 CIST Port Setting

This page allows you to configure per port CIST priority and cost. The CIST Port Setting and Status screens in [Figure 4-6-10](#) & [Figure 4-6-11](#) appear.

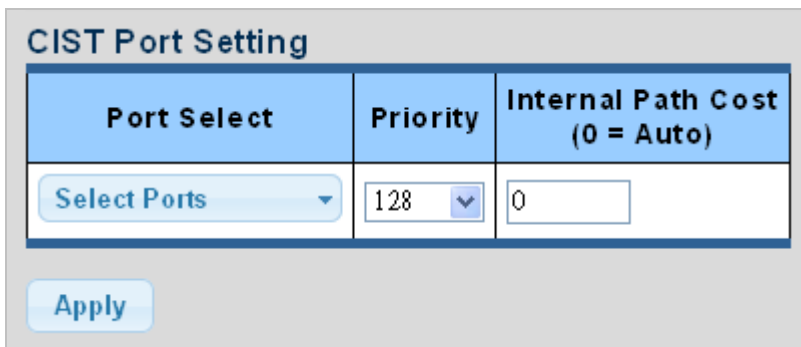

Figure 4-6-10 CIST Port Setting Page Screenshot

The page includes the following fields:

Object	Description
<ul style="list-style-type: none"> <li>• <b>Port Select</b></li> </ul>	Select port number for this drop down list.
<ul style="list-style-type: none"> <li>• <b>Priority</b></li> </ul>	<p>Controls the port priority. This can be used to control priority of ports having identical port cost. (See above).</p> <p>Default: <b>128</b></p> <p>Range: 0-240, in steps of 16</p>
<ul style="list-style-type: none"> <li>• <b>Internal Path Cost (0 = Auto)</b></li> </ul>	<p>Controls the path cost incurred by the port.</p> <p>The <b>Auto</b> setting will set the path cost as appropriate by the physical link speed, using the 802.1D recommended values. Using the <b>Specific</b> setting, a user-defined value can be entered.</p> <p>The path cost is used when establishing the active topology of the network. Lower path cost ports are chosen as forwarding ports in favor of higher path cost ports. Valid values are in the range 1 to 200000000.</p>

#### Buttons

: Click to apply changes.

CIST Port Status													
Port	Indentifier (Priority / Port ID)	External Path Cost Conf/Oper	Internal Path Cost Conf/Oper	Designated Root Bridge	External Root Cost	Regional Root Bridge	Internal Root Cost	Designated Bridge	Internal Port Path Cost	Edge Port Conf/Oper	P2P MAC Conf/Oper	Port Role	Port State
GE1	128 / 1	0 / 20000	0 / 20000	0 / 00:00:00:00:00:00	0	0 / 00:00:00:00:00:00	0	0 / 00:00:00:00:00:00	20000	No / No	Auto / No	Disabed	Disabled
GE2	128 / 2	0 / 20000	0 / 20000	0 / 00:00:00:00:00:00	0	0 / 00:00:00:00:00:00	0	0 / 00:00:00:00:00:00	20000	No / No	Auto / No	Disabed	Disabled
GE3	128 / 3	0 / 20000	0 / 20000	0 / 00:00:00:00:00:00	0	0 / 00:00:00:00:00:00	0	0 / 00:00:00:00:00:00	20000	No / No	Auto / No	Disabed	Disabled
GE4	128 / 4	0 / 20000	0 / 20000	0 / 00:00:00:00:00:00	0	0 / 00:00:00:00:00:00	0	0 / 00:00:00:00:00:00	20000	No / No	Auto / No	Disabed	Disabled
...													
LAG6	128 / 16	0 / 20000	0 / 20000	0 / 00:00:00:00:00:00	0	0 / 00:00:00:00:00:00	0	0 / 00:00:00:00:00:00	20000	No / No	Auto / No	Disabed	Disabled
LAG7	128 / 17	0 / 20000	0 / 20000	0 / 00:00:00:00:00:00	0	0 / 00:00:00:00:00:00	0	0 / 00:00:00:00:00:00	20000	No / No	Auto / No	Disabed	Disabled
LAG8	128 / 18	0 / 20000	0 / 20000	0 / 00:00:00:00:00:00	0	0 / 00:00:00:00:00:00	0	0 / 00:00:00:00:00:00	20000	No / No	Auto / No	Disabed	Disabled

Figure 4-6-11 CIST Port Status Page Screenshot

The page includes the following fields:

Object	Description
• Port	The switch port number of the logical STP port
• Indentifier (Priority / Port ID)	Displays the current indentifier (Priority / Port ID)
• External Path Cost Conf/Oper	Displays the current external path cost conf/oper
• Internal Path Cost Conf/Oper	Displays the current internal path cost/oper
• Designated Root Bridge	Displays the current designated root bridge
• External Root Cost	Displays the current external root cost
• Regional Root Bridge	Displays the current regional root bridge
• Internal Root Cost	Displays the current internal root cost
• Designated Bridge	Displays the current designated bridge
• Internal Port Path Cost	Displays the current internal port path cost
• Edge Port Conf/Oper	Displays the current edge port conf/oper
• P2P MAC Conf/Oper	Displays the current P2P MAC conf/oper
• Port Role	Displays the current port role
• Port State	Displays the current port state

### 4.6.6 MST Instance Configuration

This page allows the user to configure MST Instance Configuration. The MST Instance Setting, Information and Status screens in [Figure 4-6-12](#), [Figure 4-6-13](#) & [Figure 4-6-14](#) appear.

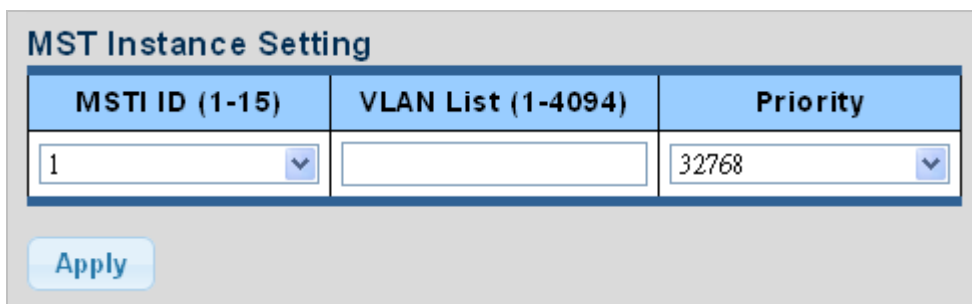

MSTI ID (1-15)	VLAN List (1-4094)	Priority
1		32768

Apply

Figure 4-6-12 MST Instance Setting Page Screenshot

The page includes the following fields:

Object	Description
<ul style="list-style-type: none"> <li><b>MSTI ID</b></li> </ul>	<p>Allow to assign MSTI ID.</p> <p>The range for the MSTI ID is 1-15.</p>
<ul style="list-style-type: none"> <li><b>VLAN List (1-4096)</b></li> </ul>	<p>Allow to assign VLAN list to special MSTI ID.</p> <p>The range for the VLAN list is 1-4094.</p>
<ul style="list-style-type: none"> <li><b>Priority</b></li> </ul>	<p>Controls the bridge priority. Lower numerical values have better priority.</p> <p>The bridge priority plus the MSTI instance number, concatenated with the 6-byte MAC address of the switch forms a Bridge Identifier.</p>

#### Buttons

: Click to apply changes.

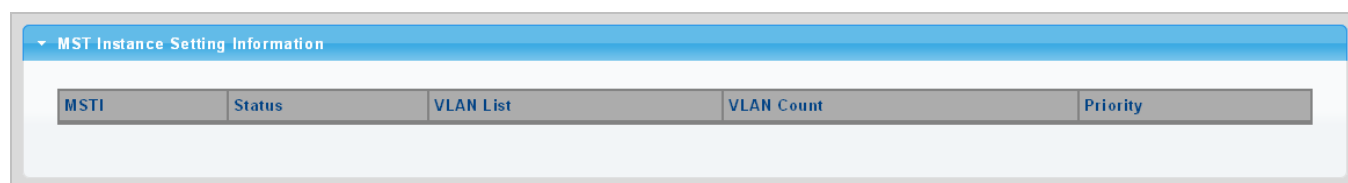

MSTI	Status	VLAN List	VLAN Count	Priority
------	--------	-----------	------------	----------

Figure 4-6-13 MSTI Instance Setting Information Page Screenshot

The page includes the following fields:

Object	Description
<ul style="list-style-type: none"> <li><b>MSTI</b></li> </ul>	Displays the current MSTI entry
<ul style="list-style-type: none"> <li><b>Status</b></li> </ul>	Displays the current MSTI status

• <b>VLAN List</b>	Displays the current VLAN list
• <b>VLAN Count</b>	Displays the current VLAN count
• <b>Priority</b>	Displays the current MSTI priority

▼ **MST Instance Status**

Information Name	Information Value
MSTI ID	1
Regional Root Bridge	--/--
Internal Root Cost	--/--
Designated Bridge	--/--
Root Port	--/--
Max Age	--/--
Forward Delay	--/--
Remaining Hops	--/--
Last Topology Change	--/--

**Figure 4-6-14** MST Instance Status Page Screenshot

The page includes the following fields:

Object	Description
• <b>MSTI ID</b>	Displays the MSTI ID.
• <b>Regional Root Bridge</b>	Displays the current designated root bridge
• <b>Internal Root Cost</b>	Displays the current internal root cost
• <b>Designated Bridge</b>	Displays the current designated bridge
• <b>Root Port</b>	Displays the current root port.
• <b>Max Age</b>	Displays the current max. age.
• <b>Forward Delay</b>	Displays the current forward delay.
• <b>Remaining Hops</b>	Displays the current remaining hops.
• <b>Last Topology Change</b>	Display the current last topology change.

### 4.6.7 MST Port Setting

This page allows the user to inspect the current STP MSTI port configurations, and possibly change them as well.

A MSTI port is a virtual port, which is instantiated separately for each active CIST (physical) port for each MSTI instance configured and applicable for the port. The MSTI instance must be selected before displaying actual MSTI port configuration options.

This page contains MSTI port settings for physical and aggregated ports. The aggregation settings are global. The MSTI Ports Setting screens in [Figure 4-6-15](#) & [Figure 4-6-16](#) appear.

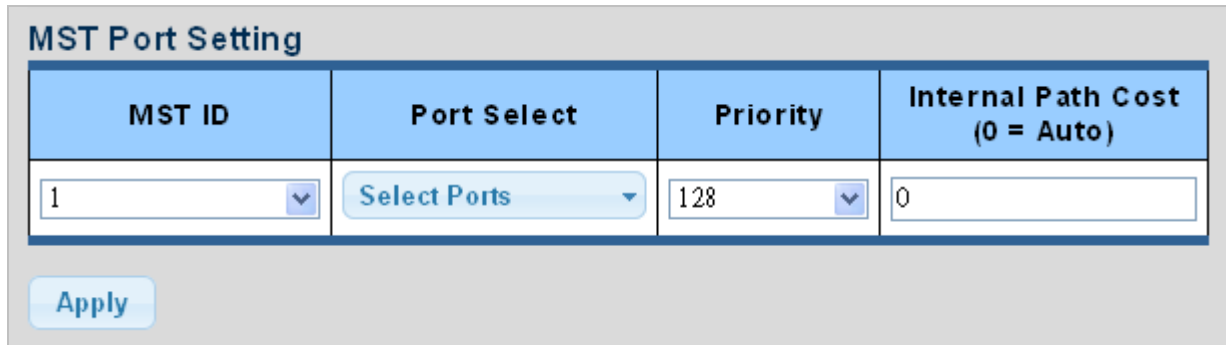

Figure 4-6-15 MST Port Configuration Page Screenshot

The page includes the following fields:

Object	Description
<ul style="list-style-type: none"> <li>• <b>MST ID</b></li> </ul>	Enter the special MST ID to configure path cost & priority.
<ul style="list-style-type: none"> <li>• <b>Port Select</b></li> </ul>	Select port number for this drop down list.
<ul style="list-style-type: none"> <li>• <b>Priority</b></li> </ul>	Controls the port priority. This can be used to control priority of ports having identical port cost.
<ul style="list-style-type: none"> <li>• <b>Internal Path Cost (0 = Auto)</b></li> </ul>	<p>Controls the path cost incurred by the port.</p> <p>The <b>Auto</b> setting will set the path cost as appropriate by the physical link speed, using the 802.1D recommended values. Using the Specific setting, a user-defined value can be entered.</p> <p>The path cost is used when establishing the active topology of the network. Lower path cost ports are chosen as forwarding ports in favor of higher path cost ports.</p> <p>Valid values are in the range 1 to 200000000.</p>

#### Buttons

: Click to apply changes.

MSTI ID	Port	Identifier (Priority / Port Id)	Internal Path Cost Conf/Oper	Regional Root Bridge	Internal Root Cost	Designated Bridge	Internal Path Cost	Port Role	Port State
1	GE1	128/1	0/--	--/--	--	--/--	--	--	--
1	GE2	128/2	0/--	--/--	--	--/--	--	--	--
1	GE3	128/3	0/--	--/--	--	--/--	--	--	--
1	GE4	128/4	0/--	--/--	--	--/--	--	--	--
1	LAG6	128/16	0/--	--/--	--	--/--	--	--	--
1	LAG7	128/17	0/--	--/--	--	--/--	--	--	--
1	LAG8	128/18	0/--	--/--	--	--/--	--	--	--

Figure 4-6-16 MST Port Status Page Screenshot

The page includes the following fields:

Object	Description
• <b>MSTI ID</b>	Displays the current MSTI ID
• <b>Port</b>	The switch port number of the logical STP port
• <b>Identifier (Priority/ Port ID)</b>	Displays the current identifier (priority / port ID)
• <b>Internal Path Cost Conf/Oper</b>	Displays the current internal path cost configuration / operation
• <b>Regional Root Bridge</b>	Displays the current regional root bridget
• <b>Internal Root Cost</b>	Displays the current internal root cost
• <b>Designated Bridge</b>	Displays the current designated bridge
• <b>Internal Path Cost</b>	Displays the current internal path cost
• <b>Port Role</b>	Displays the current port role
• <b>Port State</b>	Displays the current port state

### 4.6.8 STP Statistics

This page displays STP statistics. The STP statistics screen in [Figure 4-6-17](#) appears.

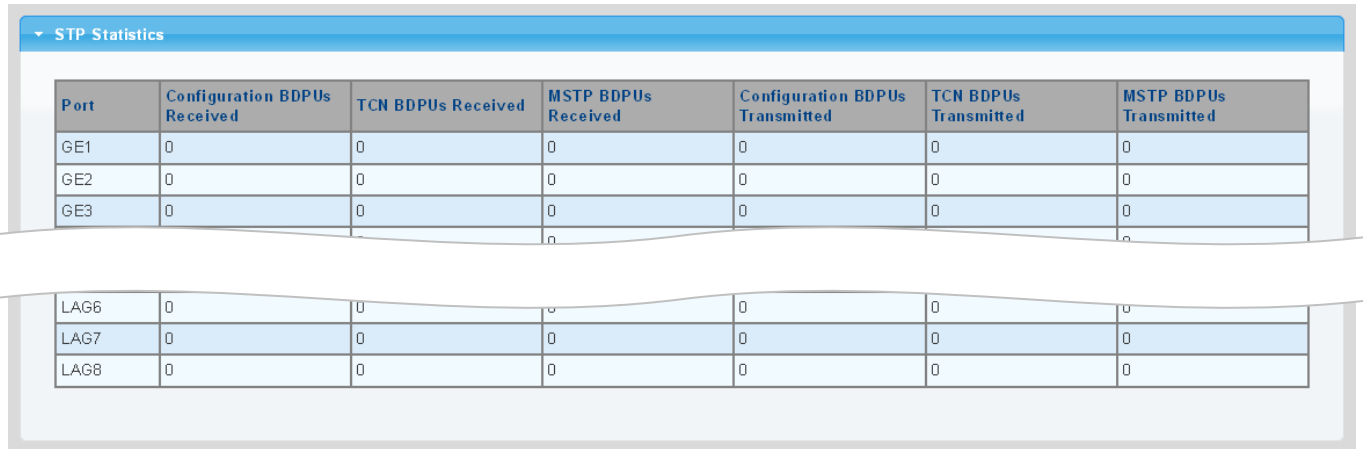

Port	Configuration BPDUs Received	TCN BPDUs Received	MSTP BPDUs Received	Configuration BPDUs Transmitted	TCN BPDUs Transmitted	MSTP BPDUs Transmitted
GE1	0	0	0	0	0	0
GE2	0	0	0	0	0	0
GE3	0	0	0	0	0	0
LAG6	0	0	0	0	0	0
LAG7	0	0	0	0	0	0
LAG8	0	0	0	0	0	0

**Figure 4-6-17** STP Statistics Page Screenshot

The page includes the following fields:

Object	Description
• <b>Port</b>	The switch port number of the logical STP port
• <b>Configuration BPDUs Received</b>	Displays the current configuration BPDUs received
• <b>TCN BPDUs Received</b>	Displays the current TCN BPDUs received
• <b>MSTP BPDUs Received</b>	Displays the current MSTP BPDUs received
• <b>Configuration BPDUs Transmitted</b>	Displays the configuration BPDUs transmitted
• <b>TCN BPDUs Transmitted</b>	Displays the current TCN BPDUs transmitted
• <b>MSTP BPDUs Transmitted</b>	Displays the current BPDUs transmitted

## 4.7 Multicast

This section has the following items:

- **Properties** Configures multicast properties
- **IGMP Snooping** Configures IGMP snooping settings
- **IGMP Snooping Statistics** Displays the IGMP snooping statistics
- **MLD Snooping** Configures MLD snooping settings
- **MLD Snooping Statistics** Displays the MLD snooping statistics
- **Multicast Throttling Setting** Configures multicast throttling setting
- **Multicast Filter** Configures multicast filter

### 4.7.1 Properties

This page provides multicast properties related configuration.

The multicast Properties and Information screen in [Figure 4-7-1](#) & [Figure 4-7-2](#) appear.

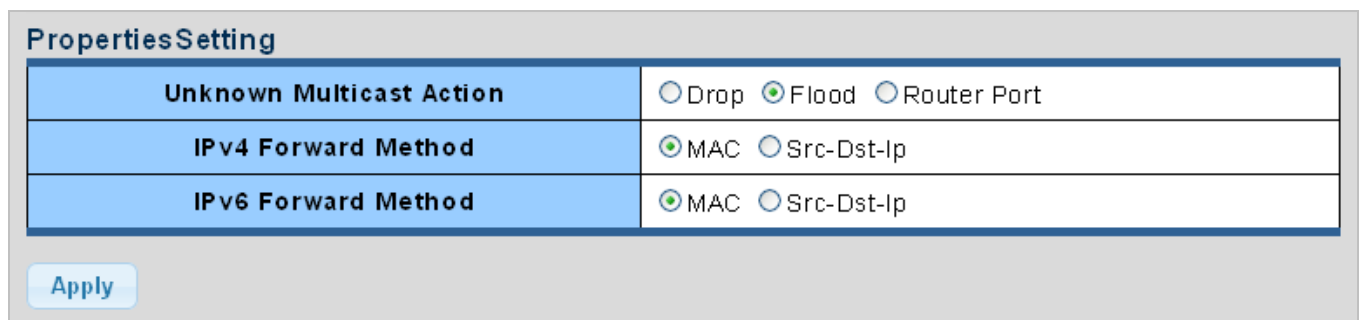

PropertiesSetting	
<b>Unknown Multicast Action</b>	<input type="radio"/> Drop <input checked="" type="radio"/> Flood <input type="radio"/> Router Port
<b>IPv4 Forward Method</b>	<input checked="" type="radio"/> MAC <input type="radio"/> Src-Dst-Ip
<b>IPv6 Forward Method</b>	<input checked="" type="radio"/> MAC <input type="radio"/> Src-Dst-Ip

Figure 4-7-1 Properties Setting Page Screenshot

The page includes the following fields:

Object	Description
• <b>Unknown Multicast Action</b>	Unknown multicast traffic method: <b>Drop</b> , <b>flood</b> or send to <b>router port</b> .
• <b>IPv4 Forward Method</b>	Configures the IPv4 multicast forward method
• <b>IPv6 Forward Method</b>	Configures the IPv6 multicast forward method

#### Buttons

: Click to apply changes.



Properties Informations	
Information Name	Information Value
Unknown Multicast Action	Flood
Forwarding Method For IPv4	MAC
Forwarding Method For IPv6	MAC

Figure 4-7-2 Properties Information Page Screenshot

The page includes the following fields:

Object	Description
<ul style="list-style-type: none"> <li>Unknown Multicast Action</li> </ul>	Displays the current unknown multicast action status
<ul style="list-style-type: none"> <li>Forward Method For IPv4</li> </ul>	Displays the current IPv4 multicast forward method
<ul style="list-style-type: none"> <li>Forward Method For IPv6</li> </ul>	Displays the current IPv6 multicast forward method

### 4.7.2 IGMP Snooping

The **Internet Group Management Protocol (IGMP)** lets host and routers share information about multicast groups memberships. IGMP snooping is a switch feature that monitors the exchange of IGMP messages and copies them to the CPU for feature processing. The overall purpose of IGMP Snooping is to limit the forwarding of multicast frames to only ports that are a member of the multicast group.

#### About the Internet Group Management Protocol (IGMP) Snooping

Computers and network devices that want to receive multicast transmissions need to inform nearby routers that they will become members of a multicast group. The **Internet Group Management Protocol (IGMP)** is used to communicate this information. IGMP is also used to periodically check the multicast group for members that are no longer active. In the case where there is more than one multicast router on a sub network, one router is elected as the 'queried'. This router then keeps track of the membership of the multicast groups that have active members. The information received from IGMP is then used to determine if multicast packets should be forwarded to a given sub network or not. The router can check, using IGMP, to see if there is at least one member of a multicast group on a given subnet work. If there are no members on a sub network, packets will not be forwarded to that sub network.

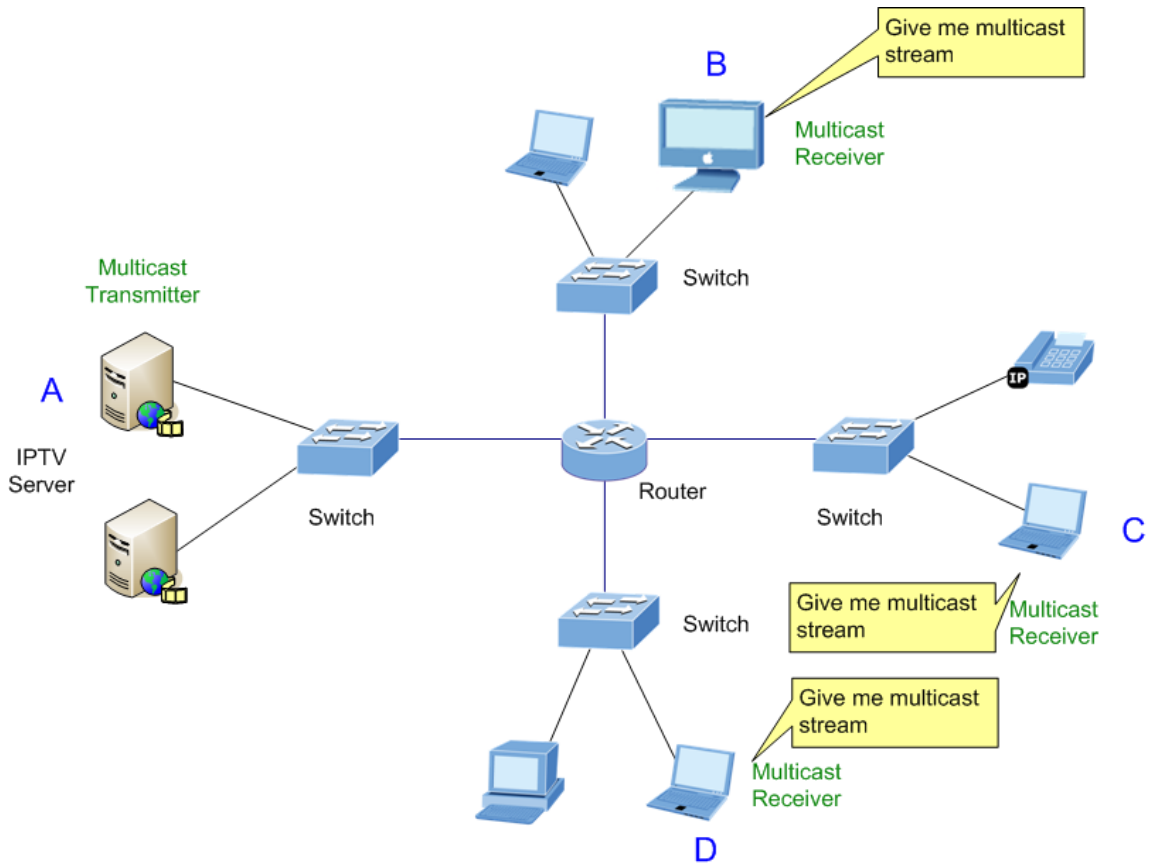

Figure 4-7-3 Multicast Service

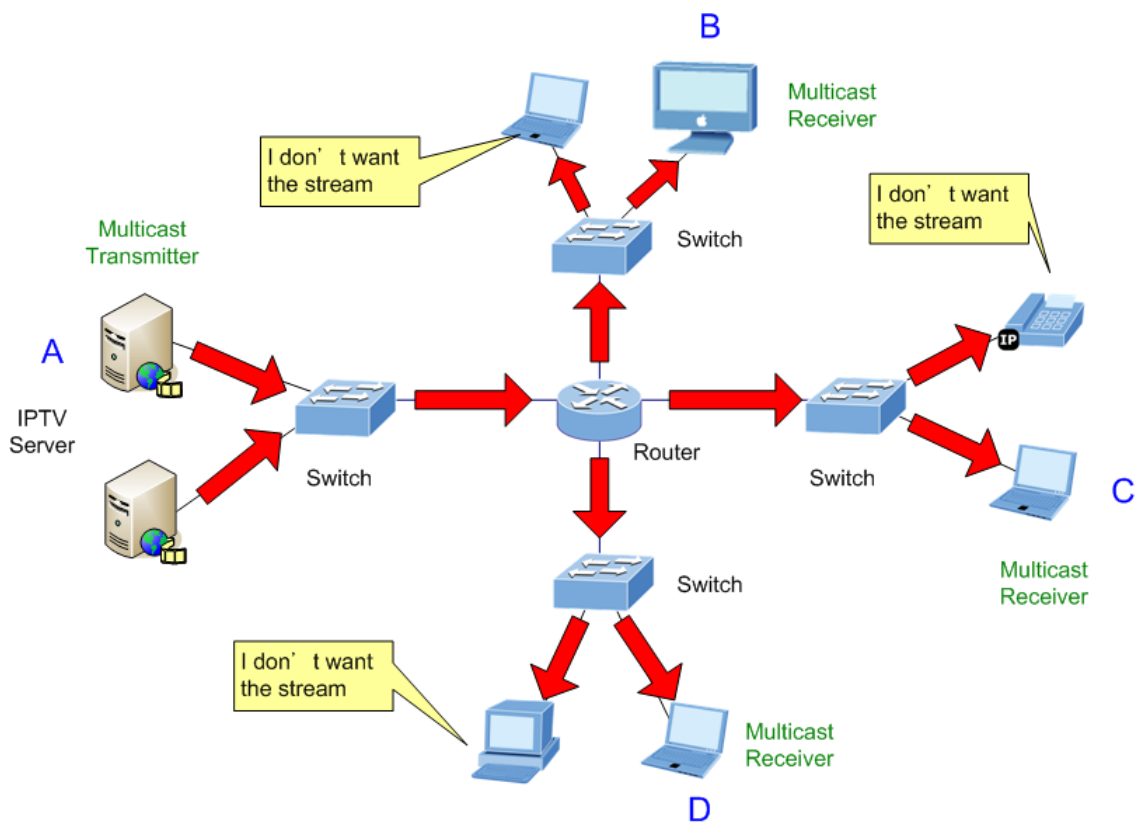

Figure 4-7-4 Multicast Flooding

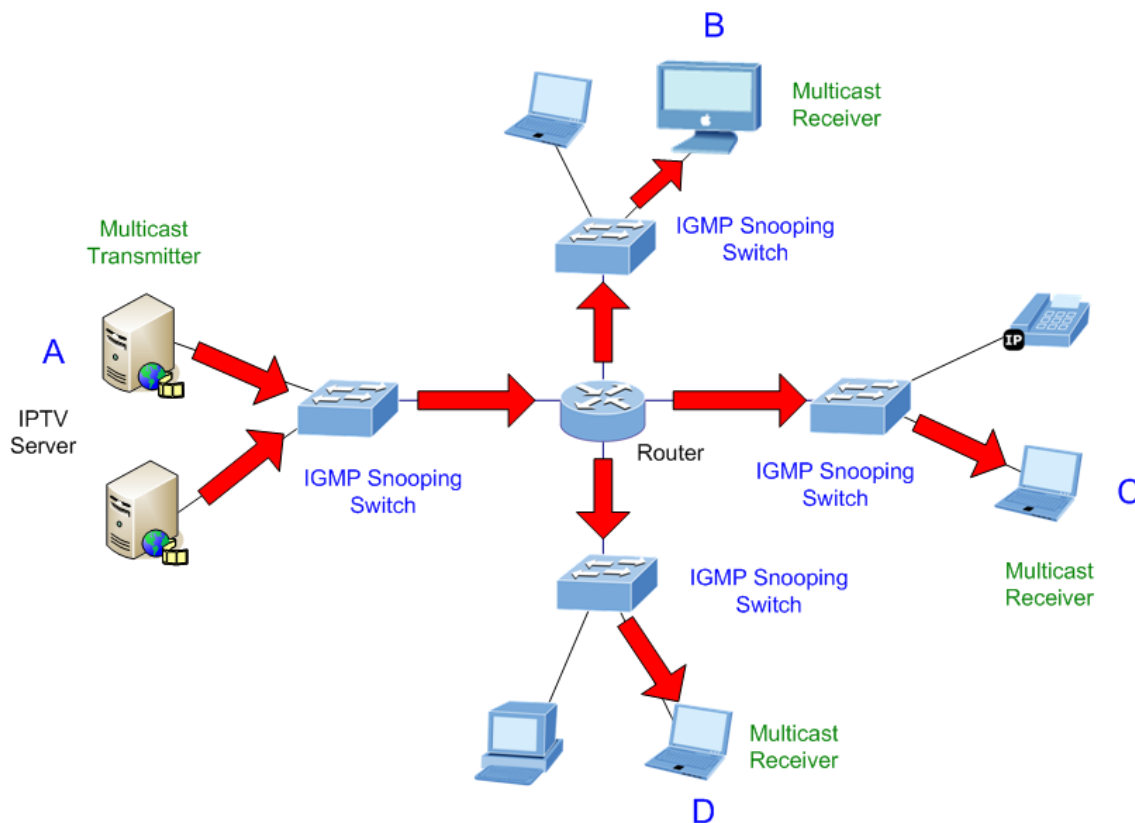

Figure 4-7-5 IGMP Snooping Multicast Stream Control

**IGMP Versions 1 and 2**

Multicast groups allow members to join or leave at any time. IGMP provides the method for members and multicast routers to communicate when joining or leaving a multicast group.

IGMP version 1 is defined in RFC 1112. It has a fixed packet size and no optional data.

The format of an IGMP packet is shown below:

**IGMP Message Format**

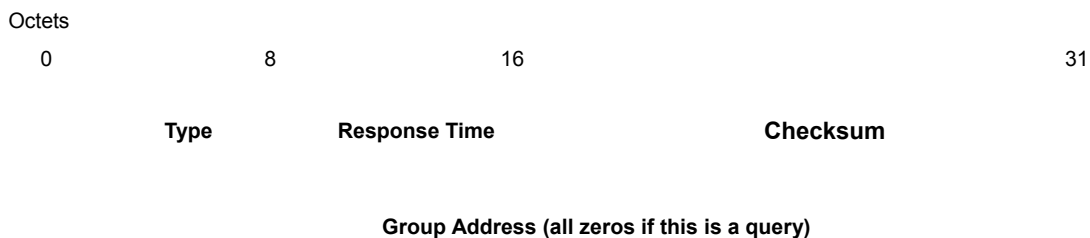

The IGMP Type codes are shown below:

Type	Meaning
0x11	Membership Query (if Group Address is 0.0.0.0)
0x11	Specific Group Membership Query (if Group Address is Present)
0x16	<b>Membership Report (version 2)</b>

0x17	Leave a Group (version 2)
0x12	Membership Report (version 1)

IGMP packets enable multicast routers to keep track of the membership of multicast groups, on their respective sub networks. The following outlines what is communicated between a multicast router and a multicast group member using IGMP.

A host sends an IGMP “**report**” to join a group

A host will never send a report when it wants to leave a group (for version 1).

A host will send a “**leave**” report when it wants to leave a group (for version 2).

Multicast routers send IGMP queries (to the all-hosts group address: 224.0.0.1) periodically to see whether any group members exist on their sub networks. If there is no response from a particular group, the router assumes that there are no group members on the network.

The Time-to-Live (TTL) field of query messages is set to 1 so that the queries will not be forwarded to other sub networks.

IGMP version 2 introduces some enhancements such as a method to elect a multicast queried for each LAN, an explicit leave message, and query messages that are specific to a given group.

The states a computer will go through to join or to leave a multicast group are shown below:

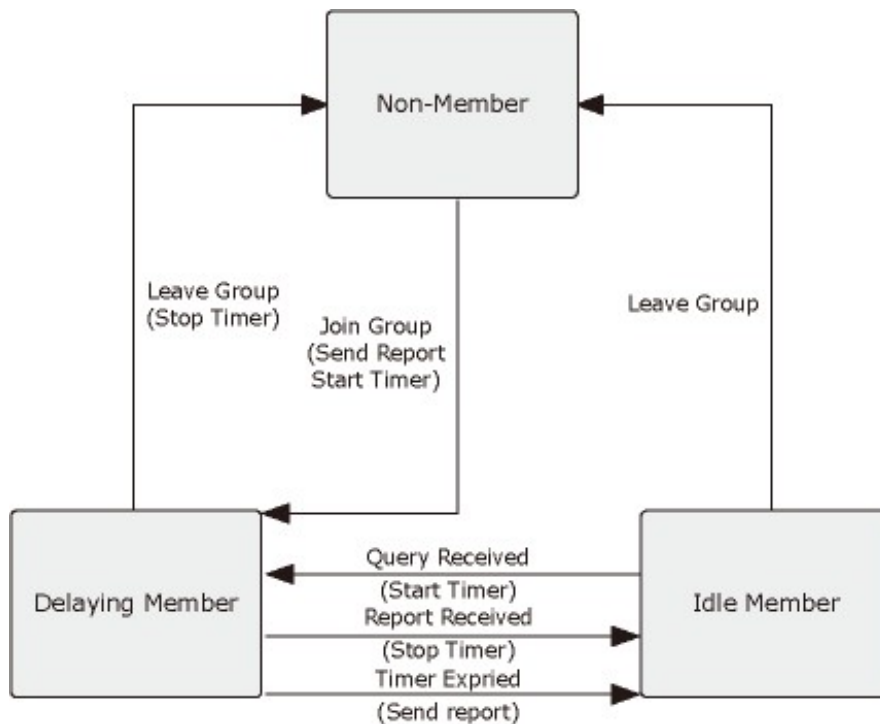

Figure 4-7-6 IGMP State Transitions

■ **IGMP Querier –**

A router, or multicast-enabled switch, can periodically ask their hosts if they want to receive multicast traffic. If there is more than one router/switch on the LAN performing IP multicasting, one of these devices is elected “**querier**” and assumes the role of querying the LAN for group members. It then propagates the service requests on to any upstream multicast switch/router to ensure that it will continue to receive the multicast service.



Multicast routers use this information, along with a multicast routing protocol such as DVMRP or PIM, to support IP multicasting across the Internet.

**4.7.2.1 IGMP Setting**

This page provides IGMP Snooping related configuration.

Most of the settings are global, whereas the Router Port configuration is related to the current unit, as reflected by the page header. The IGMP Snooping Setting and Information screens in [Figure 4-7-7](#), [Figure 4-7-8](#) & [Figure 4-7-9](#) appear.

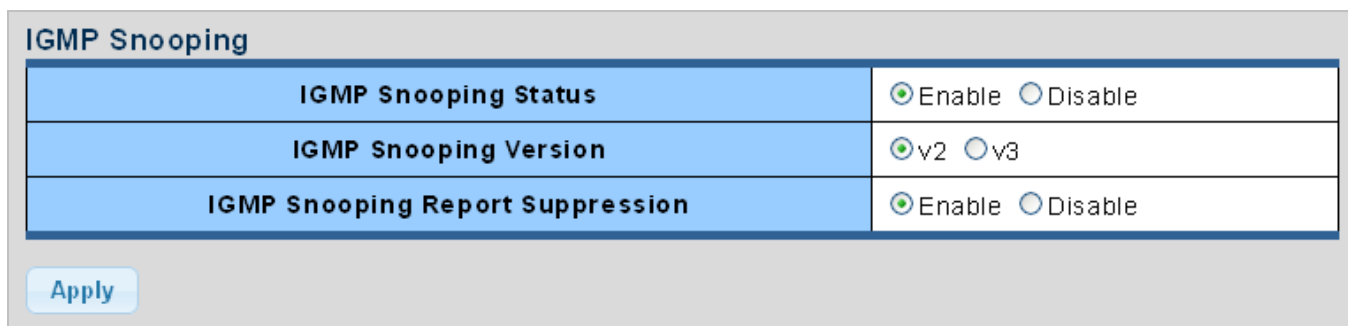

**Figure 4-7-7** IGMP Snooping Page Screenshot

The page includes the following fields:

Object	Description
<ul style="list-style-type: none"> <li>• <b>IGMP Snooping Status</b></li> </ul>	Enable or disable the IGMP snooping. The default value is "Disabled".
<ul style="list-style-type: none"> <li>• <b>IGMP Snooping Version</b></li> </ul>	Sets the IGMP Snooping operation version. Possible versions are: <ul style="list-style-type: none"> <li>■ <b>v2</b>: Set IGMP Snooping supported IGMP version 2.</li> <li>■ <b>v3</b>: Set IGMP Snooping supported IGMP version 3.</li> </ul>
<ul style="list-style-type: none"> <li>• <b>IGMP Snooping Report Suppression</b></li> </ul>	Limits the membership report traffic sent to multicast-capable routers. When you disable report suppression, all IGMP reports are sent as is to multicast-capable routers. The default is enabled.

**Buttons**



: Click to apply changes.

IGMP Snooping Informations	
Information Name	Information Value
IGMP Snooping Status	Enable
IGMP Snooping Version	v2
IGMP Snooping V2 Report Suppression	Enable

Figure 4-7-8 IGMP Snooping Information Page Screenshot

The page includes the following fields:

Object	Description
<ul style="list-style-type: none"> <li>IGMP Snooping Status</li> </ul>	Displays the current IGMP snooping status.
<ul style="list-style-type: none"> <li>IGMP Snooping Version</li> </ul>	Displays the current IGMP snooping version.
<ul style="list-style-type: none"> <li>IGMP Snooping V2 Report Suppression</li> </ul>	Displays the current IGMP snooping v2 report suppression.

IGMP Snooping Table										
Entry No.	VLAN ID	IGMP Snooping Operation Status	Router Ports Auto Learn	Query Robustness	Query Interval(sec.)	Query Max Response Interval(sec.)	Last Member Query count	Last Member Query Interval(sec)	Immediate Leave	Modify
1	1	disabled	enabled	2	125	10	2	1	disabled	<a href="#">Edit</a>

Figure 4-7-9 IGMP Snooping Information Page Screenshot

The page includes the following fields:

Object	Description
<ul style="list-style-type: none"> <li>Entry No.</li> </ul>	Displays the current entry number
<ul style="list-style-type: none"> <li>VLAN ID</li> </ul>	Displays the current VLAN ID
<ul style="list-style-type: none"> <li>IGMP Snooping Operation Status</li> </ul>	Displays the current IGMP snooping operation status
<ul style="list-style-type: none"> <li>Router Ports Auto Learn</li> </ul>	Displays the current router ports auto learning
<ul style="list-style-type: none"> <li>Query Robustness</li> </ul>	Displays the current query robustness
<ul style="list-style-type: none"> <li>Query Interval (sec.)</li> </ul>	Displays the current query interval
<ul style="list-style-type: none"> <li>Query Max Response Interval (sec.)</li> </ul>	Displays the current query max response interval
<ul style="list-style-type: none"> <li>Last Member Query count</li> </ul>	Displays the current last member query count
<ul style="list-style-type: none"> <li>Last Member Query Interval (sec)</li> </ul>	Displays the current last member query interval

• <b>Immediate Leave</b>	Displays the current immediate leave
• <b>Modify</b>	Click  to edit parameter

### 4.7.2.2 IGMP Querier Setting

This page provides IGMP Querier Setting. The IGMP Querier Setting screens in [Figure 4-7-10](#) & [Figure 4-7-11](#) appear.

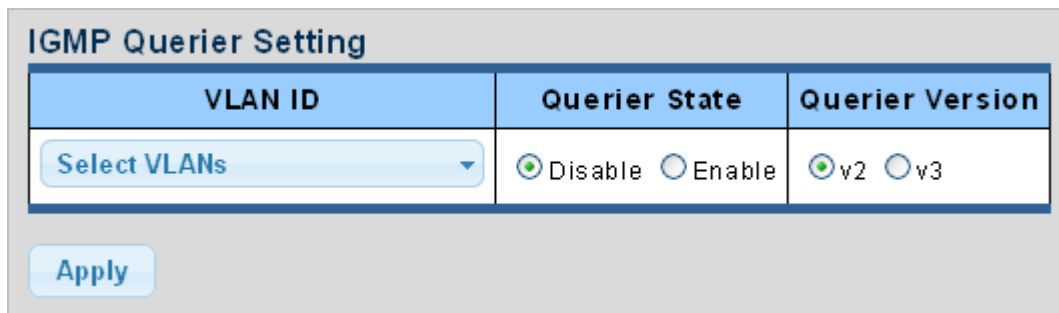

Figure 4-7-10 IGMP VLAN Setting Page Screenshot

The page includes the following fields:

Object	Description
• <b>VLAN ID</b>	Select VLAN ID from this drop-down list.
• <b>Querier State</b>	Enable or disable the querier state. The default value is "Disabled".
• <b>Querier Version</b>	Sets the querier version for compatibility with other devices on the network. Version: 2 or 3; Default: <b>2</b>

#### Buttons

: Click to apply changes.

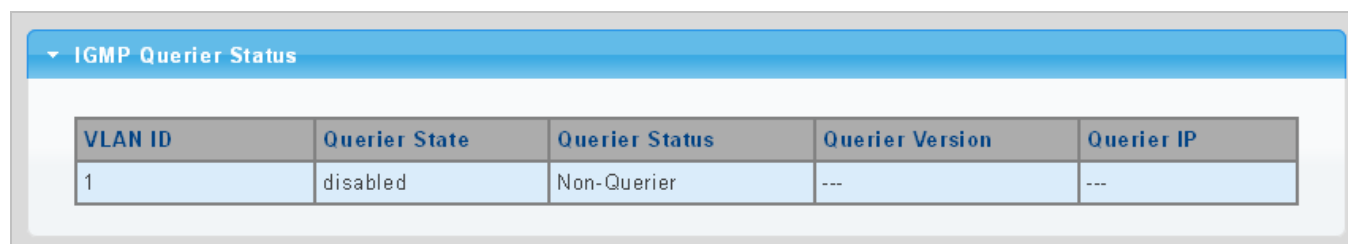

Figure 4-7-11 IGMP Querier Status Page Screenshot

The page includes the following fields:

Object	Description
• VLAN ID	Displays the current VLAN ID
• Querier State	Displays the current querier state
• Querier Status	Displays the current querier status
• Querier Version	Displays the current querier version
• Querier IP	Displays the current querier IP

### 4.7.2.3 IGMP Static Group

Multicast filtering can be dynamically configured using IGMP Snooping and IGMP Query messages as described in above sections. For certain applications that require tighter control, you may need to statically configure a multicast service on the Industrial Managed Switch. First add all the ports attached to participating hosts to a common VLAN, and then assign the multicast service to that VLAN group.

- Static multicast addresses are never aged out.
- When a multicast address is assigned to an interface in a specific VLAN, the corresponding traffic can only be forwarded to ports within that VLAN.

The IGMP Static Group configuration screens in [Figure 4-7-12](#) & [Figure 4-7-13](#) appear.

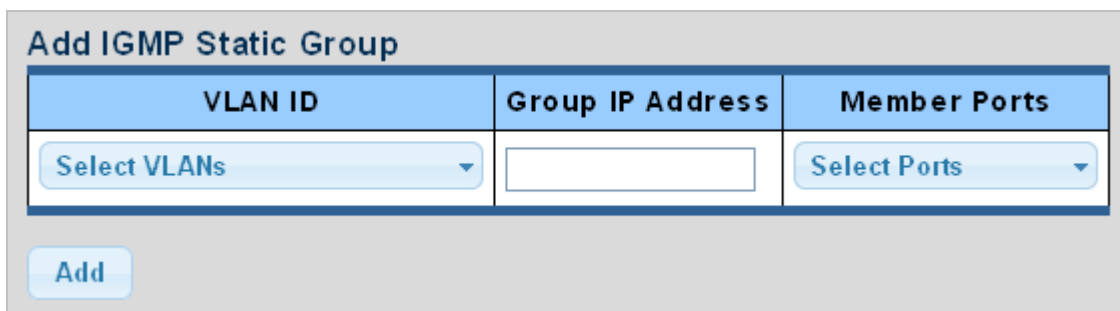

Figure 4-7-12 Add IGMP Static Group Page Screenshot

The page includes the following fields:

Object	Description
• VLAN ID	Select VLAN ID for this drop down list
• Group IP Address	The IP address for a specific multicast service
• Member Ports	Select port number for this drop down list

#### Buttons

: Click to add IGMP router port entry.



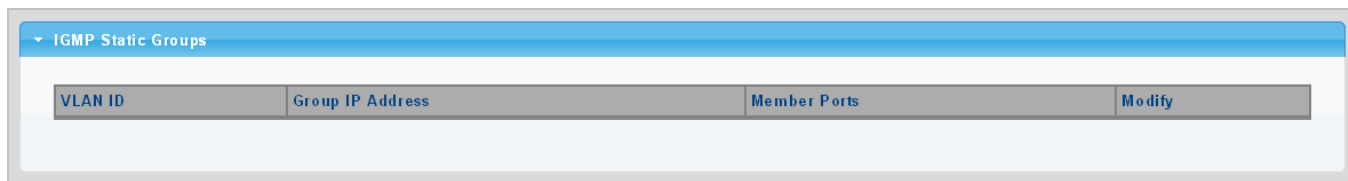



Figure 4-7-13 IGMP Static Groups Page Screenshot

The page includes the following fields:

Object	Description
• VLAN ID	Displays the current VLAN ID
• Group IP Address	Displays the current group IP address
• Member Ports	Displays the current member ports
• Modify	Click  to edit parameter

#### 4.7.2.4 IGMP Group Table

This page provides Multicast Database. The IGMP Group Table screen in [Figure 4-7-14](#) appears.

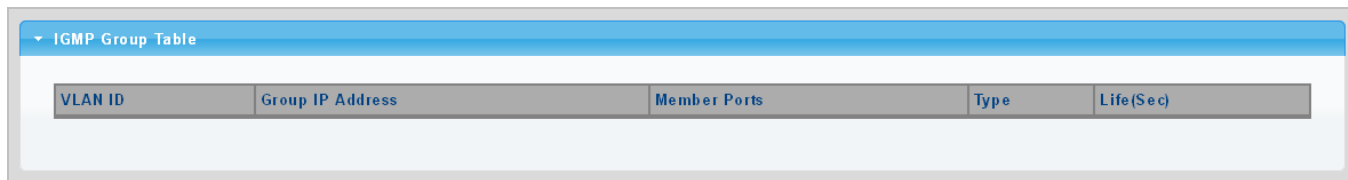

Figure 4-7-14 IGMP Group Table Page Screenshot

The page includes the following fields:

Object	Description
• VLAN ID	Displays the current VID
• Group IP Address	Displays multicast IP address for a specific multicast service
• Member Port	Displays the current member port
• Type	Member types displayed include Static or Dynamic, depending on selected options
• Life(Se c)	Displays the current life

### 4.7.2.5 IGMP Router Setting

Depending on your network connections, IGMP snooping may not always be able to locate the IGMP querier. Therefore, if the IGMP querier is a known multicast router/ switch connected over the network to an interface (port or trunk) on your Industrial Managed Switch, you can manually configure the interface (and a specified VLAN) to join all the current multicast groups supported by the attached router. This can ensure that multicast traffic is passed to all the appropriate interfaces within the Industrial Managed Switch.

The IGMP Router Setting and Status screens in [Figure 4-7-15](#) & [Figure 4-7-16](#) appear.

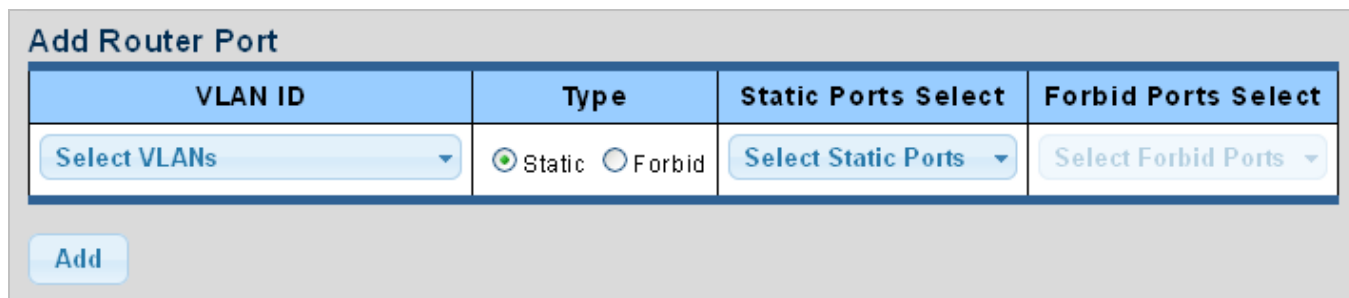

VLAN ID	Type	Static Ports Select	Forbid Ports Select
Select VLANs	<input checked="" type="radio"/> Static <input type="radio"/> Forbid	Select Static Ports	Select Forbid Ports

Add

Figure 4-7-15 Add Router Port Page Screenshot

The page includes the following fields:

Object	Description
• <b>VLAN ID</b>	Selects the VLAN to propagate all multicast traffic coming from the attached multicast router.
• <b>Type</b>	Sets the Router port type. The types of Router port as below: <ul style="list-style-type: none"> <li>■ <b>Static</b></li> <li>■ <b>Forbid</b></li> </ul>
• <b>Static Ports Select</b>	Specify which ports act as router ports. A router port is a port on the Ethernet switch that leads towards the Layer 3 multicast device or IGMP querier.
• <b>Forbid Port Select</b>	Specify which ports un-act as router ports

#### Buttons



**Add**: Click to add IGMP router port entry.



VLAN ID	Static Ports	Forbidden Ports	Modify
---------	--------------	-----------------	--------

Figure 4-7-16 Router Port Status Page Screenshot

The page includes the following fields:

Object	Description
• VLAN ID	Displays the current VLAN ID
• Static Ports	Displays the current static ports
• Forbidden Ports	Displays the current forbidden ports
• Modify	Click  to edit parameter Click  to delete the group ID entry

#### 4.7.2.6 IGMP Router Table

This page provides Router Table. The Dynamic, Static and Forbidden Router Table screens in [Figure 4-7-17](#), [Figure 4-7-18](#) & [Figure 4-7-19](#) appear.

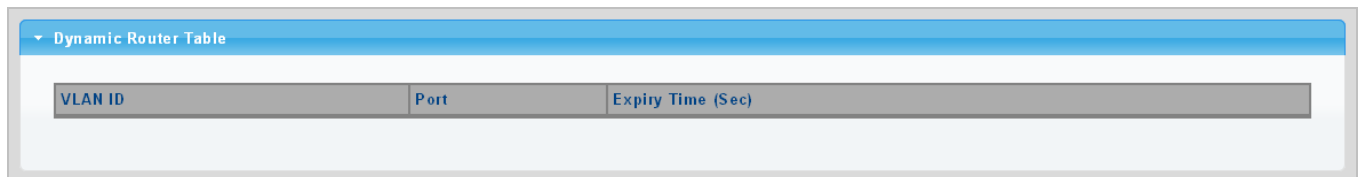

Figure 4-7-17 Dynamic Router Table Page Screenshot

The page includes the following fields:

Object	Description
• VLAN ID	Displays the current VLAN ID
• Port	Displays the current dynamic router ports
• Expiry Time (Sec)	Displays the current expiry time

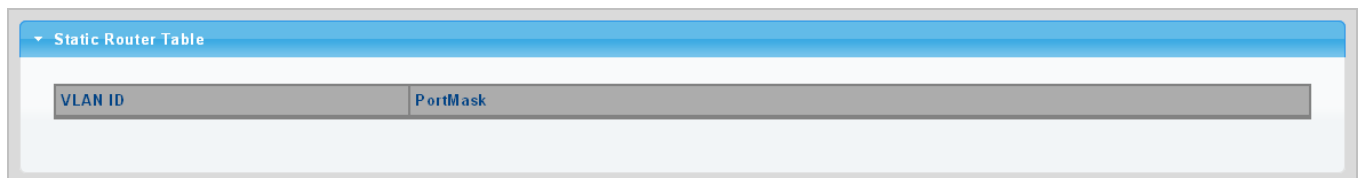

Figure 4-7-18 Static Router Table Page Screenshot

The page includes the following fields:

Object	Description
• VLAN ID	Displays the current VLAN ID
• Port Mask	Displays the current port mask

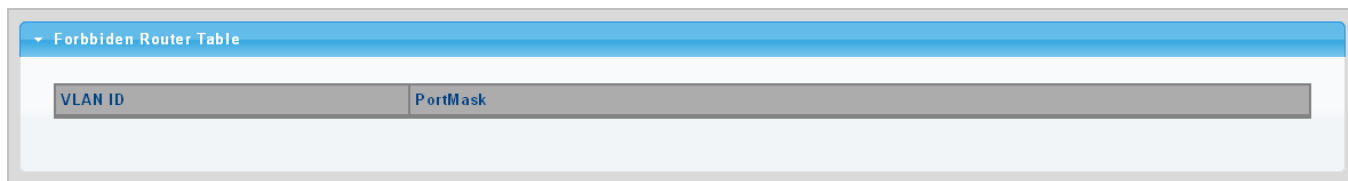

Figure 4-7-19 Forbidden Router Table Page Screenshot

The page includes the following fields:

Object	Description
• VLAN ID	Displays the current VLAN ID
• Port Mask	Displays the current port mask

#### 4.7.2.7 IGMP Forward All

This page provides IGMP Forward All. The Forward All screen in Figure 4-7-20 appears.

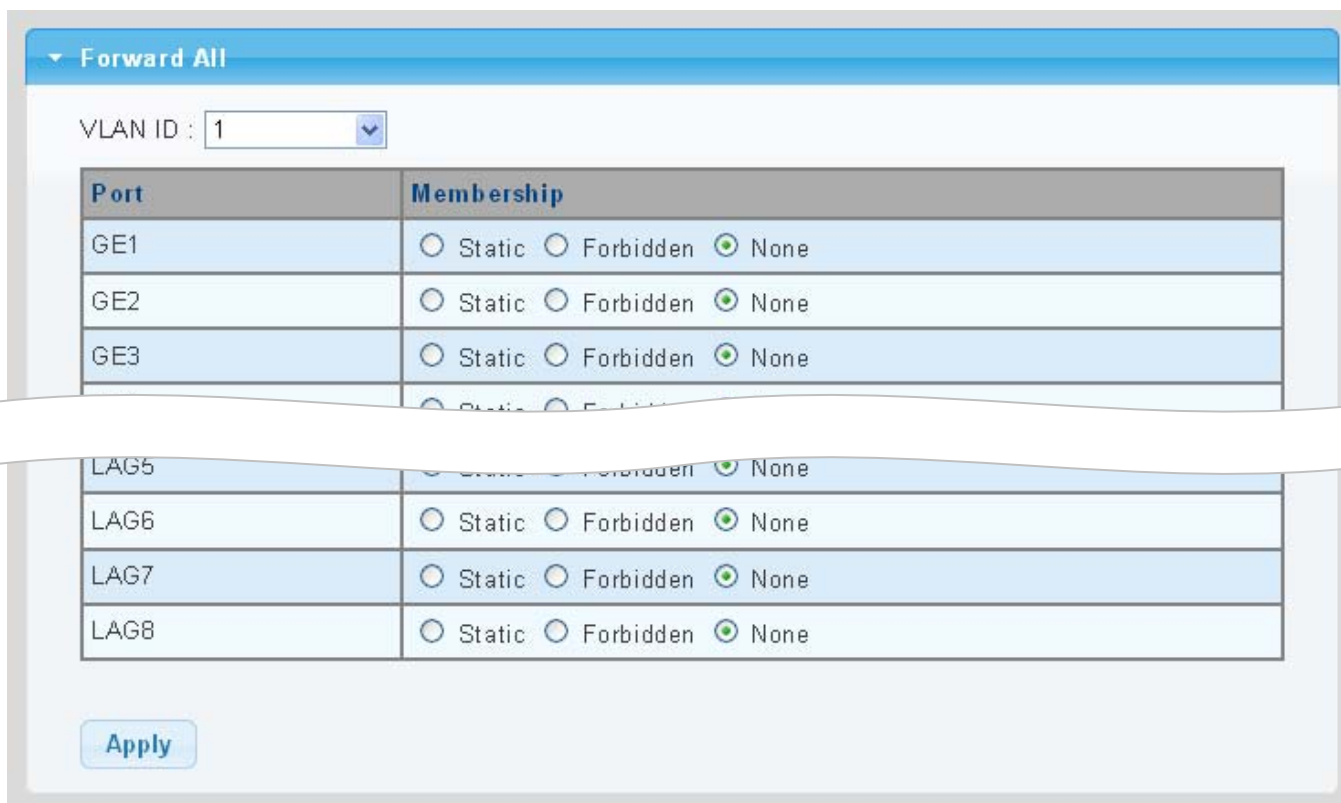

Figure 4-7-20 Forward All Setting Page Screenshot

The page includes the following fields:

Object	Description
• VLAN ID	Select VLAN ID from this drop-down list to assign IGMP membership

• <b>Port</b>	The switch port number of the logical port	
• <b>Membership</b>	Select IGMP membership for each interface:	
	<b>Forbidden:</b>	Interface is forbidden from automatically joining the IGMP via MVR.
	<b>None:</b>	Interface is not a member of the VLAN. Packets associated with this VLAN will not be transmitted by the interface.
	<b>Static:</b>	Interface is a member of the IGMP.

**Buttons**



: Click to apply changes.

### 4.7.3 IGMP Snooping Statics

This page provides IGMP Snooping Statics. The IGMP Snooping Statics screen in [Figure 4-7-20](#) appears.

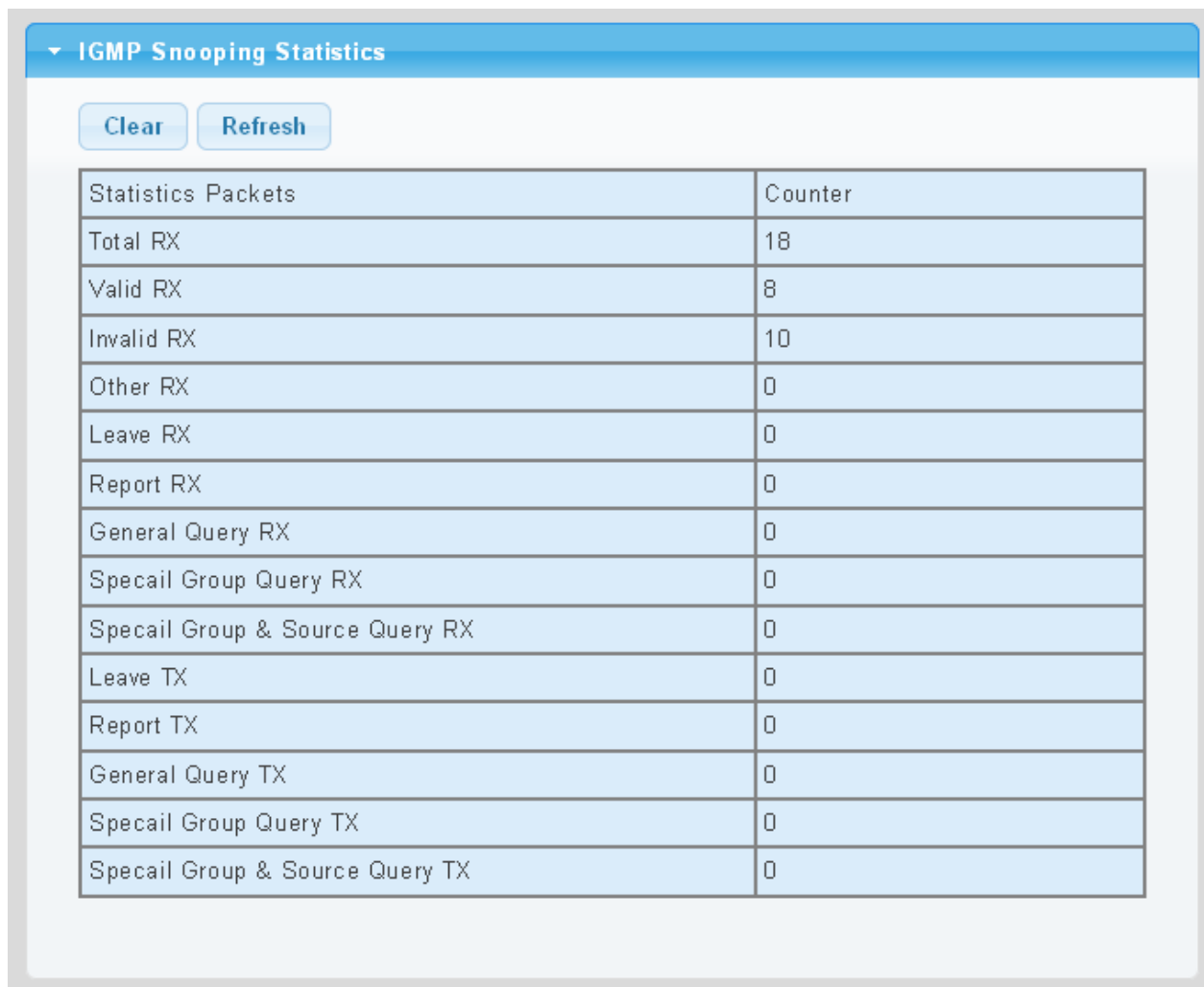

IGMP Snooping Statistics	
Statistics Packets	Counter
Total RX	18
Valid RX	8
Invalid RX	10
Other RX	0
Leave RX	0
Report RX	0
General Query RX	0
Specail Group Query RX	0
Specail Group & Source Query RX	0
Leave TX	0
Report TX	0
General Query TX	0
Specail Group Query TX	0
Specail Group & Source Query TX	0

**Figure 4-7-20** Forward All Setting Page Screenshot

The page includes the following fields:

Object	Description
• Total RX	Displays the current total RX
• Valid RX	Displays the current valid RX
• Invalid RX	Displays the current invalid RX
• Other RX	Displays the current other RX
• Leave RX	Displays the current leave RX
• Report RX	Displays the current report RX
• General Query RX	Displays the current general query RX
• Special Group Query RX	Displays the current special group query RX
• Special Group & Source Query RX	Displays the current special group & source query RX
• Leave TX	Displays the current leave TX
• Report TX	Displays the current report TX
• General Query TX	Displays the current general query TX
• Special Group Query TX	Displays the current special group query TX
• Special Group & Source Query TX	Displays the current special group & source query TX

**Buttons**

**Clear** : Click to clear the IGMP Snooping Statistics.

**Refresh** : Click to refresh the IGMP Snooping Statistics.

## 4.7.4 MLD Snooping

### 4.7.4.1 MLD Setting

This page provides MLD Snooping related configuration.

Most of the settings are global, whereas the Router Port configuration is related to the current unit, as reflected by the page header. The MLD Snooping Setting, Information and Table screens in [Figure 4-7-21](#), [Figure 4-7-22](#) & [Figure 4-7-23](#) appear.

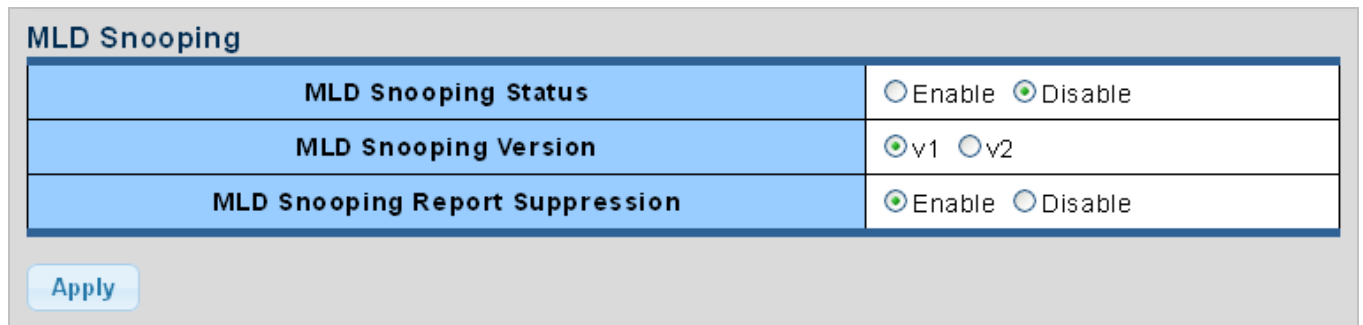

MLD Snooping	
MLD Snooping Status	<input type="radio"/> Enable <input checked="" type="radio"/> Disable
MLD Snooping Version	<input checked="" type="radio"/> v1 <input type="radio"/> v2
MLD Snooping Report Suppression	<input checked="" type="radio"/> Enable <input type="radio"/> Disable

Figure 4-7-21 MLD Snooping Page Screenshot

The page includes the following fields:

Object	Description
<ul style="list-style-type: none"> <li>MLD Snooping Status</li> </ul>	Enable or disable the MLD snooping. The default value is "Disabled".
<ul style="list-style-type: none"> <li>MLD Snooping Version</li> </ul>	Sets the MLD Snooping operation version. Possible versions are: <ul style="list-style-type: none"> <li><b>v1</b>: Set MLD Snooping supported MLD version 1.</li> <li><b>v2</b>: Set MLD Snooping supported MLD version 2.</li> </ul>
<ul style="list-style-type: none"> <li>MLD Snooping Report Suppression</li> </ul>	Limits the membership report traffic sent to multicast-capable routers. When you disable report suppression, all MLD reports are sent as is to multicast-capable routers. The default is enabled.

#### Buttons

: Click to apply changes.

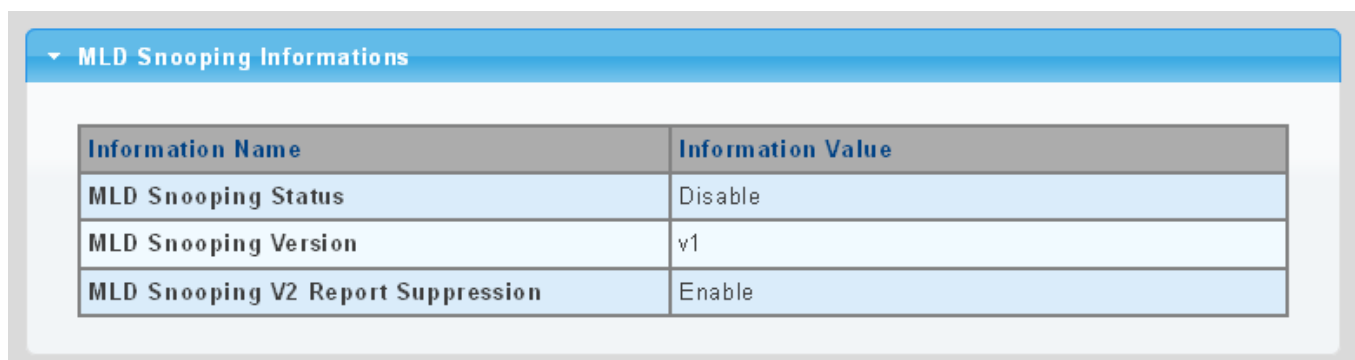

MLD Snooping Informations	
Information Name	Information Value
MLD Snooping Status	Disable
MLD Snooping Version	v1
MLD Snooping V2 Report Suppression	Enable

Figure 4-7-22 MLD Snooping information Page Screenshot

The page includes the following fields:

Object	Description
• <b>MLD Snooping Status</b>	Displays the current MLD snooping status
• <b>MLD Snooping Version</b>	Displays the current MLD snooping version
• <b>MLD Snooping Report Suppression</b>	Displays the current MLD snooping report suppression

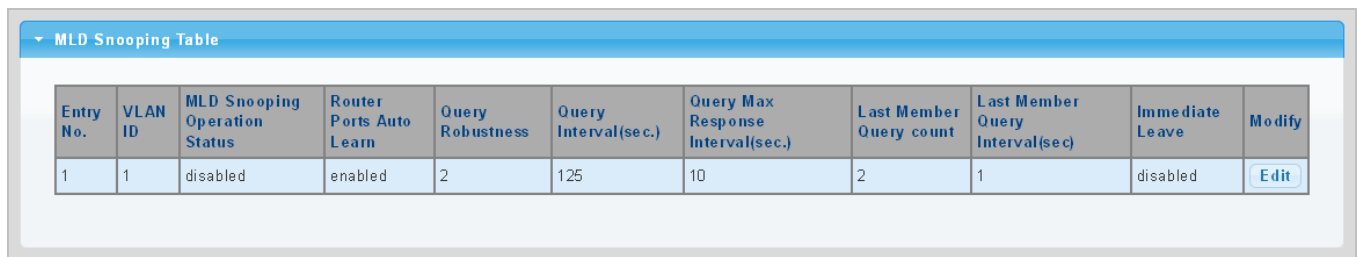

Entry No.	VLAN ID	MLD Snooping Operation Status	Router Ports Auto Learn	Query Robustness	Query Interval(sec.)	Query Max Response Interval(sec.)	Last Member Query count	Last Member Query Interval(sec)	Immediate Leave	Modify
1	1	disabled	enabled	2	125	10	2	1	disabled	<a href="#">Edit</a>

Figure 4-7-23 MLD Snooping Table Page Screenshot

The page includes the following fields:

Object	Description
• <b>Entry No.</b>	Displays the current entry number
• <b>VLAN ID</b>	Displays the current VLAN ID
• <b>MLD Snooping Operation Status</b>	Displays the current MLD snooping operation status
• <b>Router Ports Auto Learn</b>	Displays the current router ports auto learning
• <b>Query Robustness</b>	Displays the current query robustness
• <b>Query Interval (sec.)</b>	Displays the current query interval
• <b>Query Max Response Interval (sec.)</b>	Displays the current query max response interval
• <b>Last Member Query count</b>	Displays the current last member query count
• <b>Last Member Query Interval (sec)</b>	Displays the current last member query interval
• <b>Immediate Leave</b>	Displays the current immediate leave
• <b>Modify</b>	Click <a href="#">Edit</a> to edit parameter



### 4.7.4.2 MLD Static Group

The MLD Static Group configuration screens in [Figure 4-7-24](#) & [Figure 4-7-25](#) appear.

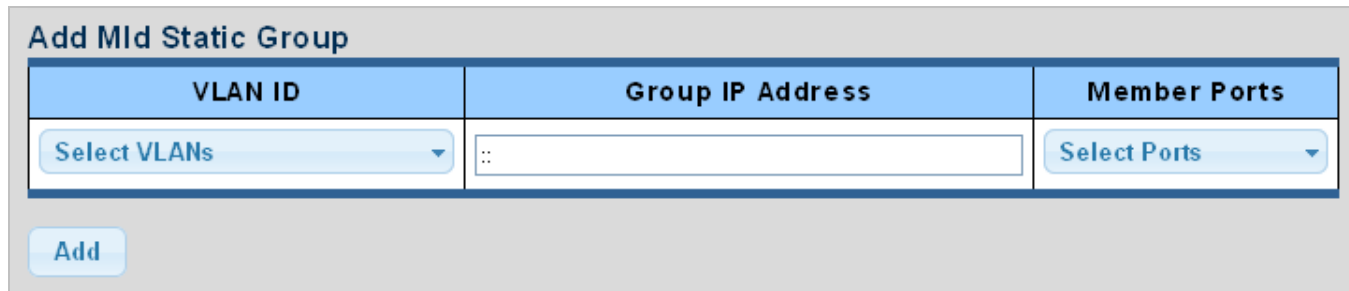

**Figure 4-7-24** Add MLD Static Group Page Screenshot

The page includes the following fields:

Object	Description
• VLAN ID	Select VLAN ID for this drop down list
• Group IP Address	The IP address for a specific multicast service
• Member Ports	Select port number for this drop down list

#### Buttons

: Click to add IGMP router port entry.

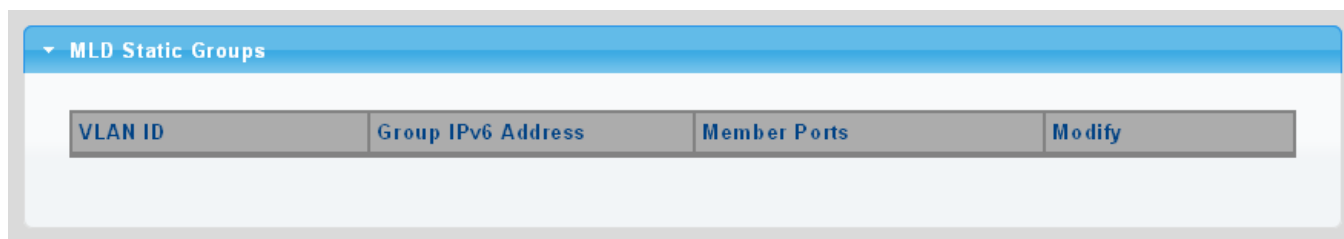

**Figure 4-7-25** MLD Static Groups Page Screenshot

The page includes the following fields:

Object	Description
• VLAN ID	Displays the current VLAN ID
• Group IPv6 Address	Displays the current group IPv6 address
• Member Ports	Displays the current member ports
• Modify	Click  to edit parameter.

### 4.7.4.3 MLD Group Table

This page provides MLD Group Table. The MLD Group Table screen in [Figure 4-7-26](#) appears.

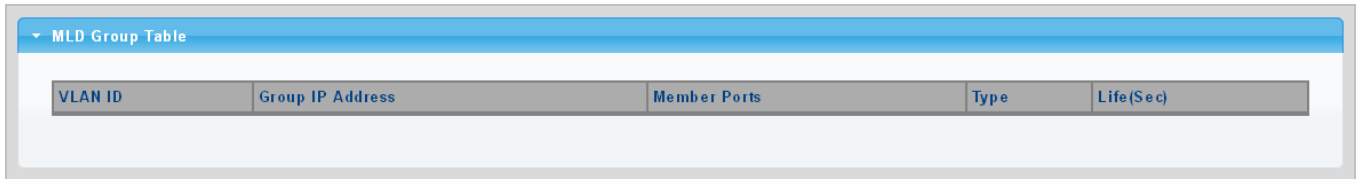

**Figure 4-7-26** MLD Group Table Page Screenshot

The page includes the following fields:

Object	Description
• VLAN ID	Displays the current VID
• Group IP Address	Displays multicast IP address for a specific multicast service
• Member Port	Displays the current member port
• Type	Member types displayed include Static or Dynamic, depending on selected options
• Life(Se c)	Displays the current life

### 4.7.4.4 MLD Router Setting

Depending on your network connections, MLD snooping may not always be able to locate the MLD querier. Therefore, if the MLD querier is a known multicast router/ switch connected over the network to an interface (port or trunk) on your Industrial Managed Switch, you can manually configure the interface (and a specified VLAN) to join all the current multicast groups supported by the attached router. This can ensure that multicast traffic is passed to all the appropriate interfaces within the Industrial Managed Switch.

The MLD Router Setting screens in [Figure 4-7-27](#) & [Figure 4-7-28](#) appear.

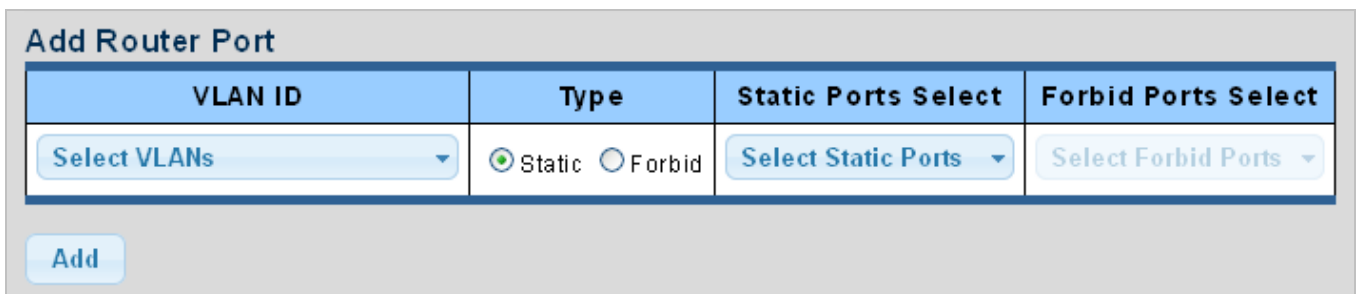

**Figure 4-7-27** Add Router Port Page Screenshot

The page includes the following fields:

Object	Description
<ul style="list-style-type: none"> <li><b>VLAN ID</b></li> </ul>	Selects the VLAN to propagate all multicast traffic coming from the attached multicast router
<ul style="list-style-type: none"> <li><b>Type</b></li> </ul>	Sets the Router port type. The types of Router port as below: <b>Static</b> <b>Forbid</b>
<ul style="list-style-type: none"> <li><b>Static Ports Select</b></li> </ul>	Specify which ports act as router ports. A router port is a port on the Ethernet switch that leads towards the Layer 3 multicast device or MLD querier.
<ul style="list-style-type: none"> <li><b>Forbid Port Select</b></li> </ul>	Specify which ports un-act as router ports

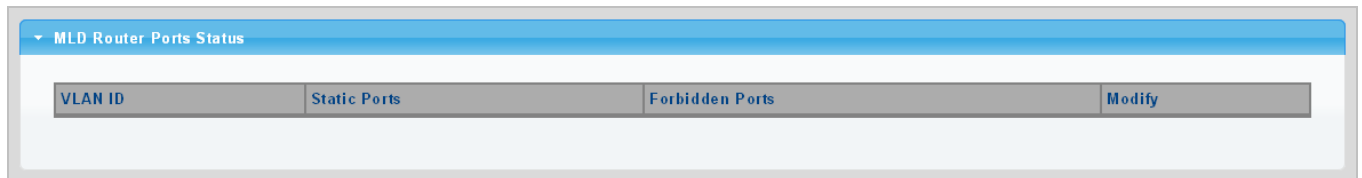

**Buttons**

 : Click to add MLD router port entry.



**Figure 4-7-28** Router Port Status Page Screenshot

The page includes the following fields:

Object	Description
<ul style="list-style-type: none"> <li><b>VLAN ID</b></li> </ul>	Displays the current VLAN ID
<ul style="list-style-type: none"> <li><b>Static Ports</b></li> </ul>	Displays the current static ports
<ul style="list-style-type: none"> <li><b>Forbidden Ports</b></li> </ul>	Displays the current forbidden ports
<ul style="list-style-type: none"> <li><b>Modify</b></li> </ul>	Click  to edit parameter  Click  to delete the group ID entry

#### 4.7.4.5 MLD Router Table

This page provides Router Table. The Dynamic, Static and Forbidden Router Table screens in [Figure 4-7-29](#), [Figure 4-7-30](#) & [Figure 4-7-31](#) appear.

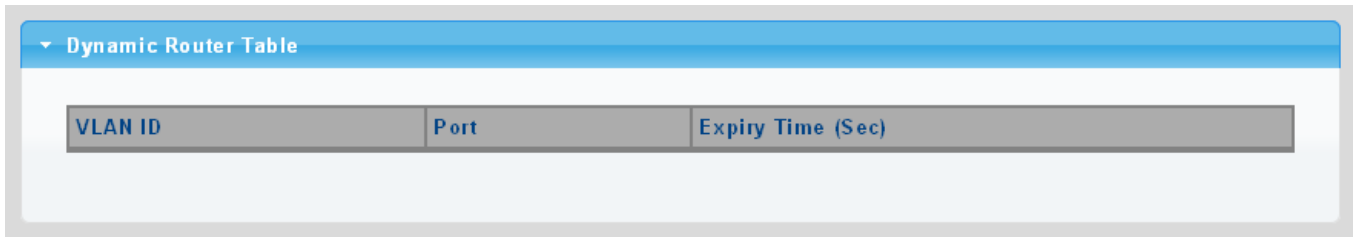

**Figure 4-7-29** Dynamic Router Table Page Screenshot

The page includes the following fields:

Object	Description
• VLAN ID	Displays the current VLAN ID
• Port	Displays the current dynamic router ports
• Expiry Time (Sec)	Displays the current expiry time

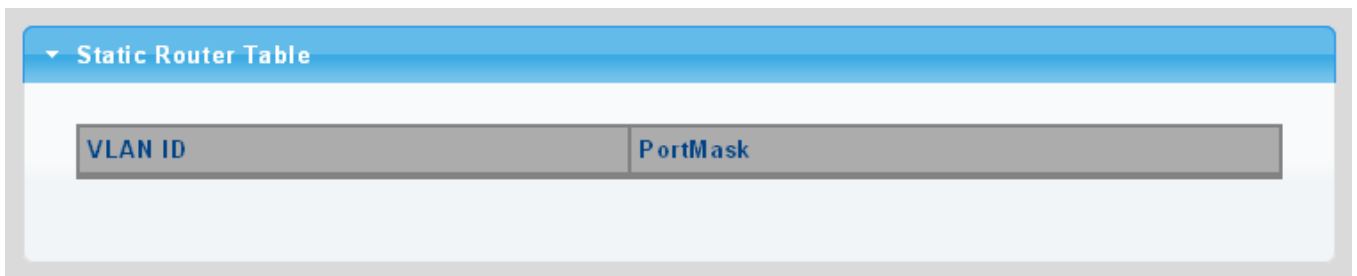

**Figure 4-7-30** Static Router Table Page Screenshot

The page includes the following fields:

Object	Description
• VLAN ID	Displays the current VLAN ID
• Port Mask	Displays the current port mask

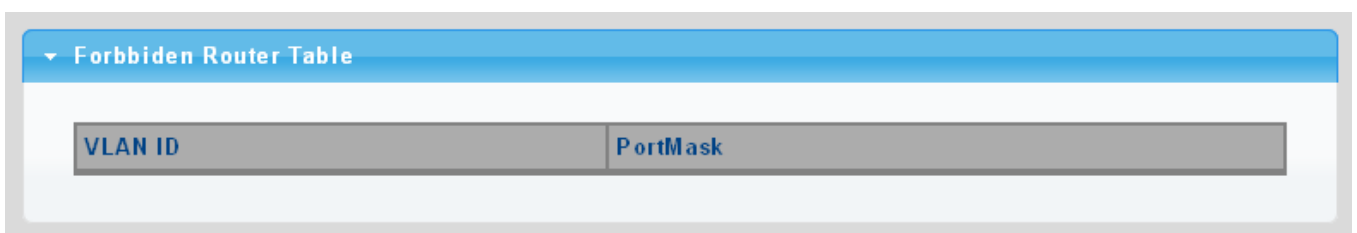

**Figure 4-7-31** Forbidden Router Table Page Screenshot

The page includes the following fields:

Object	Description
• VLAN ID	Displays the current VLAN ID
• Port Mask	Displays the current port mask

#### 4.7.4.6 MLD Forward All

This page provides MLD Forward All. The Forward All screen in [Figure 4-7-32](#) appears.

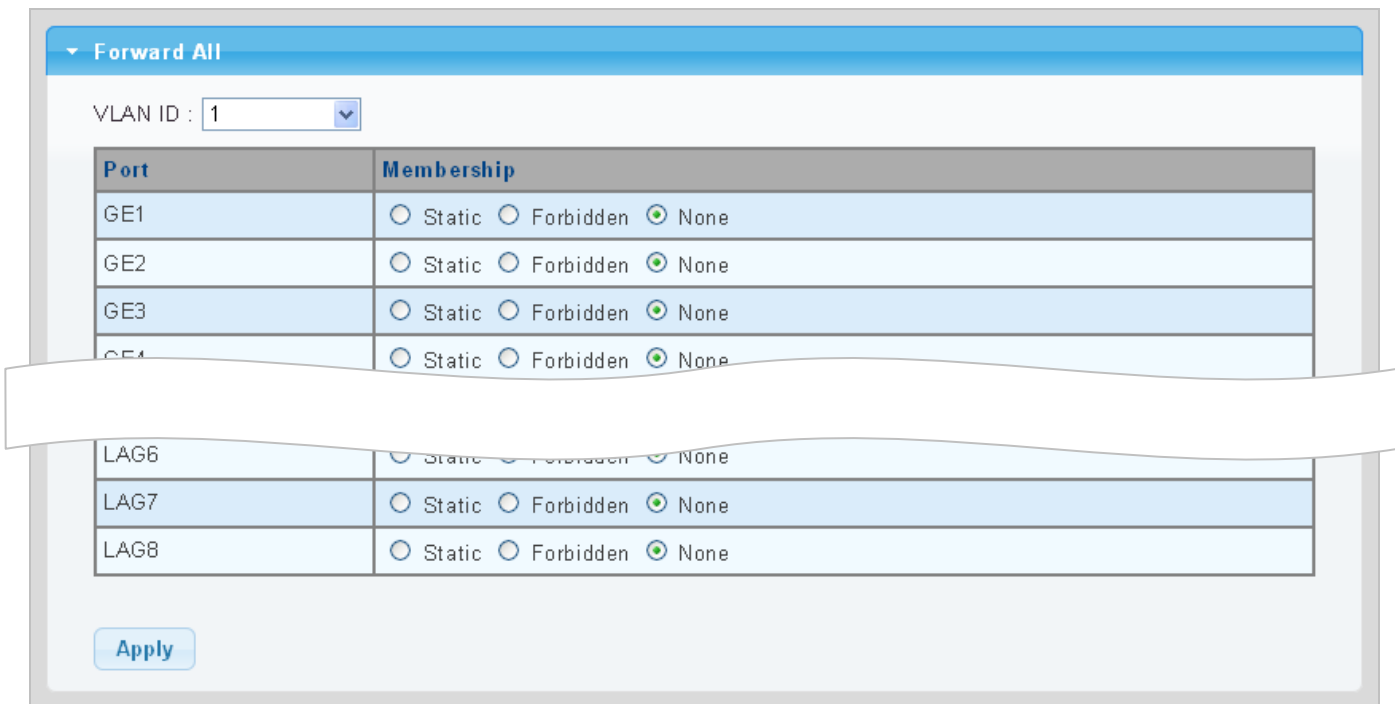

**Figure 4-7-32** Forward All Setting Page Screenshot

The page includes the following fields:

Object	Description	
• VLAN ID	Select VLAN ID for this drop down list to assign MLD membership	
• Port	The switch port number of the logical port	
• Membership	Select MLD membership for each interface:	
	<b>Forbidden:</b>	Interface is forbidden from automatically joining the MLD via MVR.
	<b>None:</b>	Interface is not a member of the VLAN. Packets associated with this VLAN will not be transmitted by the interface.
	<b>Static:</b>	Interface is a member of the MLD.

#### Buttons

: Click to apply changes.

### 4.7.5 MLD Snooping Statics

This page provides MLD Snooping Statics. The MLD Snooping Statics screen in [Figure 4-7-33](#) appears.

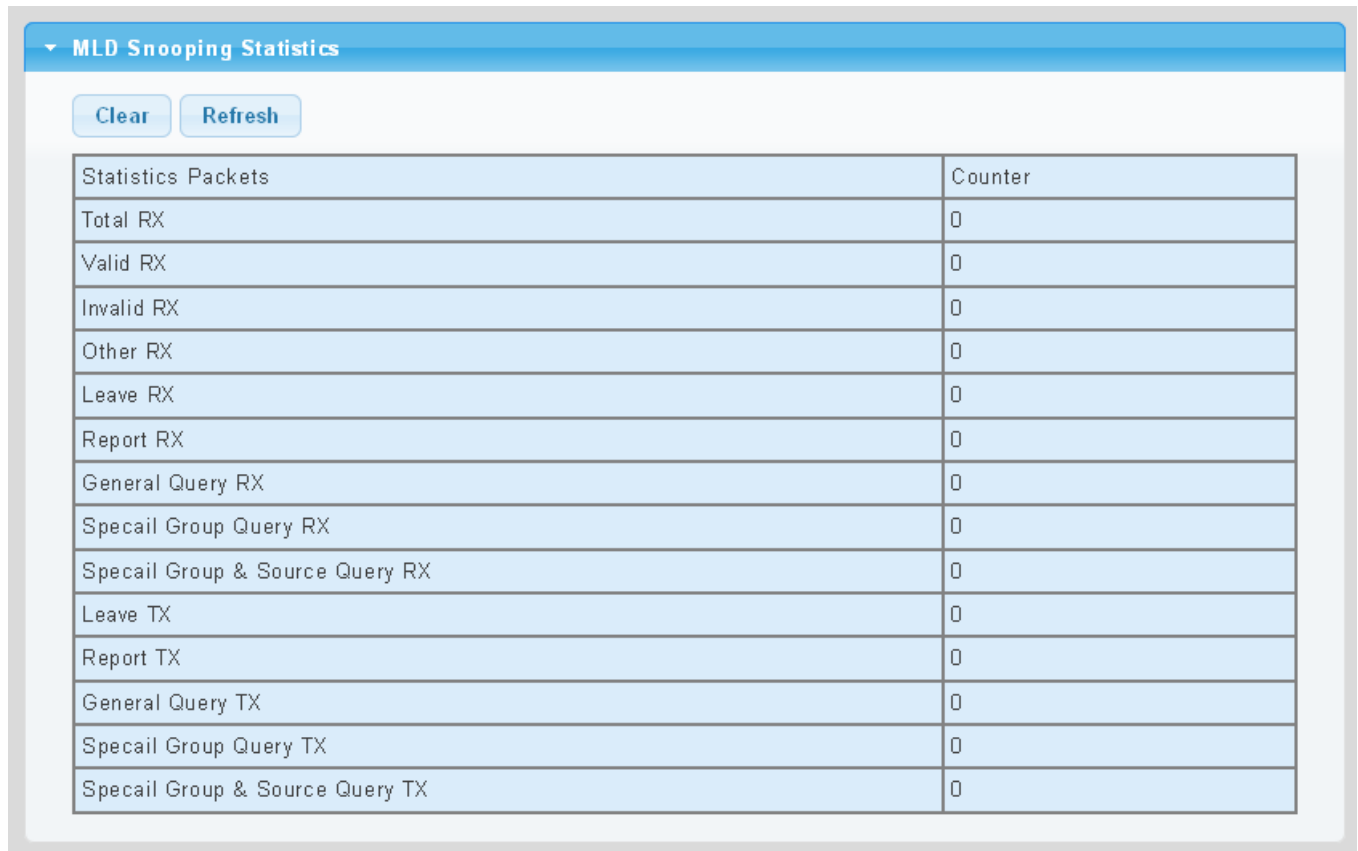

MLD Snooping Statistics	
Clear	Refresh
Statistics Packets	Counter
Total RX	0
Valid RX	0
Invalid RX	0
Other RX	0
Leave RX	0
Report RX	0
General Query RX	0
Specail Group Query RX	0
Specail Group & Source Query RX	0
Leave TX	0
Report TX	0
General Query TX	0
Specail Group Query TX	0
Specail Group & Source Query TX	0

**Figure 4-7-33** Forward All Setting Page Screenshot

The page includes the following fields:

Object	Description
• <b>Total RX</b>	Displays the current total RX
• <b>Valid RX</b>	Displays the current valid RX
• <b>Invalid RX</b>	Displays the current invalid RX
• <b>Other RX</b>	Displays the current other RX
• <b>Leave RX</b>	Displays the current leave RX
• <b>Report RX</b>	Displays the current report RX
• <b>General Query RX</b>	Displays the current general query RX
• <b>Special Group Query RX</b>	Displays the current special group query RX
• <b>Special Group &amp; Source Query RX</b>	Displays the current special group & source query RX
• <b>Leave TX</b>	Displays the current leave TX

• <b>Report TX</b>	Displays the current report TX
• <b>General Query TX</b>	Displays the current general query TX
• <b>Special Group Query TX</b>	Displays the current special group query TX
• <b>Special Group &amp; Source Query TX</b>	Displays the current special group & source query TX

**Buttons**



: Click to clear the MLD Snooping Statistics.



: Click to refresh the MLD Snooping Statistics.

### 4.7.6 Multicast Throttling Setting

Multicast throttling sets a maximum number of multicast groups that a port can join at the same time. When the maximum number of groups is reached on a port, the switch can take one of two actions; either “deny” or “replace”. If the action is set to deny, any new multicast join reports will be dropped. If the action is set to replace, the switch randomly removes an existing group and replaces it with the new multicast group.

Once you have configured multicast profiles, you can assign them to interfaces on the Industrial Managed Switch. Also you can set the multicast throttling number to limit the number of multicast groups an interface can join at the same time. The MAX Group and Information screens in [Figure 4-7-34](#) & [Figure 4-7-35](#) appear.

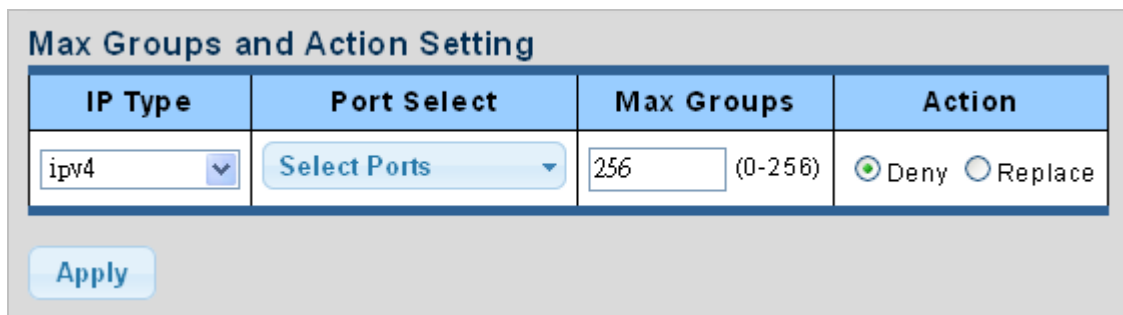

Figure 4-7-34 Max Groups and Action Setting Page Screenshot

The page includes the following fields:

Object	Description
• IP Type	Select IPv4 or IPv6 for this drop down list
• Port Select	Select port number for this drop down list
• Max Groups	Sets the maximum number of multicast groups an interface can join at the same time. Range: 0-256; Default: <b>256</b>
• Action	Sets the action to take when the maximum number of multicast groups for the interface has been exceeded. (Default: Deny) -Deny - The new multicast group join report is dropped -Replace - The new multicast group replaces an existing group

#### Buttons

: Click to apply changes.



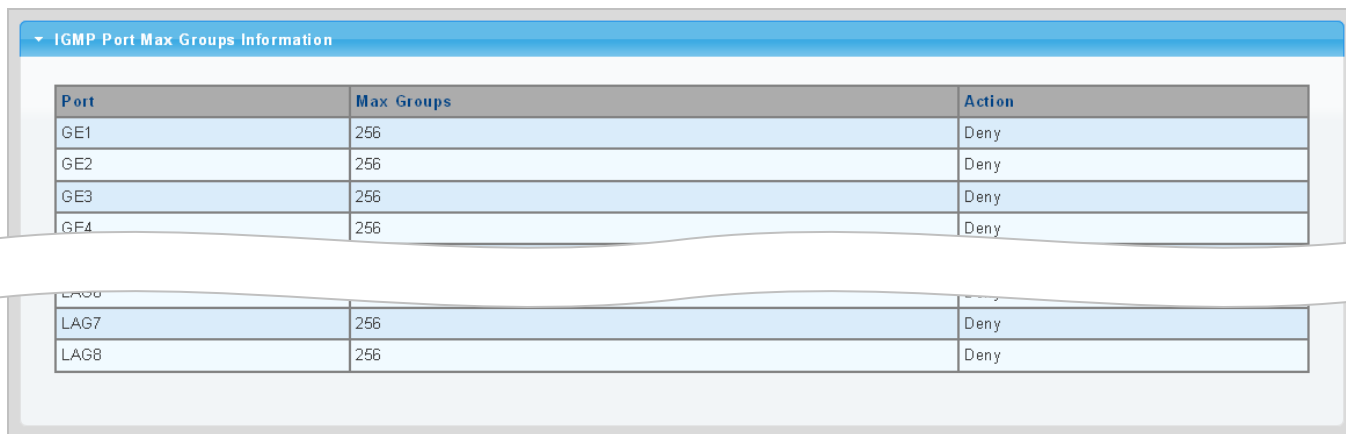

Port	Max Groups	Action
GE1	256	Deny
GE2	256	Deny
GE3	256	Deny
GE4	256	Deny
LAG6	256	Deny
LAG7	256	Deny
LAG8	256	Deny

Figure 4-7-35 IGMP Port Max Groups Information Page Screenshot

The page includes the following fields:

Object	Description
<ul style="list-style-type: none"> <li>• <b>Port</b></li> </ul>	The switch port number of the logical port
<ul style="list-style-type: none"> <li>• <b>Max Groups</b></li> </ul>	Displays the current Max groups
<ul style="list-style-type: none"> <li>• <b>Action</b></li> </ul>	Displays the current action

### 4.7.7 Multicast Filter

In certain switch applications, the administrator may want to control the multicast services that are available to end users. For example, an IP/TV service is based on a specific subscription plan. The multicast filtering feature fulfills this requirement by restricting access to specified multicast services on a switch port.

Multicast filtering enables you to assign a profile to a switch port that specifies multicast groups that are permitted or denied on the port. A multicast filter profile can contain one or more, or a range of multicast addresses; but only one profile can be assigned to a port. When enabled, multicast join reports received on the port are checked against the filter profile. If a requested multicast group is permitted, the multicast join report is forwarded as normal. If a requested multicast group is denied, the multicast join report is dropped.

When you have created a Multicast profile number, you can then configure the multicast groups to filter and set the access mode.

#### Command Usage

- Each profile has only one access mode; either **permit** or **deny**.
- When the access mode is set to **permit**, multicast join reports are processed when a multicast group falls within the controlled range.
- When the access mode is set to **deny**, multicast join reports are only processed when the multicast group is not in the controlled range.

### 4.7.7.1 Multicast Profile Setting

The Add Profile and Profile Status screens in [Figure 4-7-36](#) & [Figure 4-7-37](#) appear.

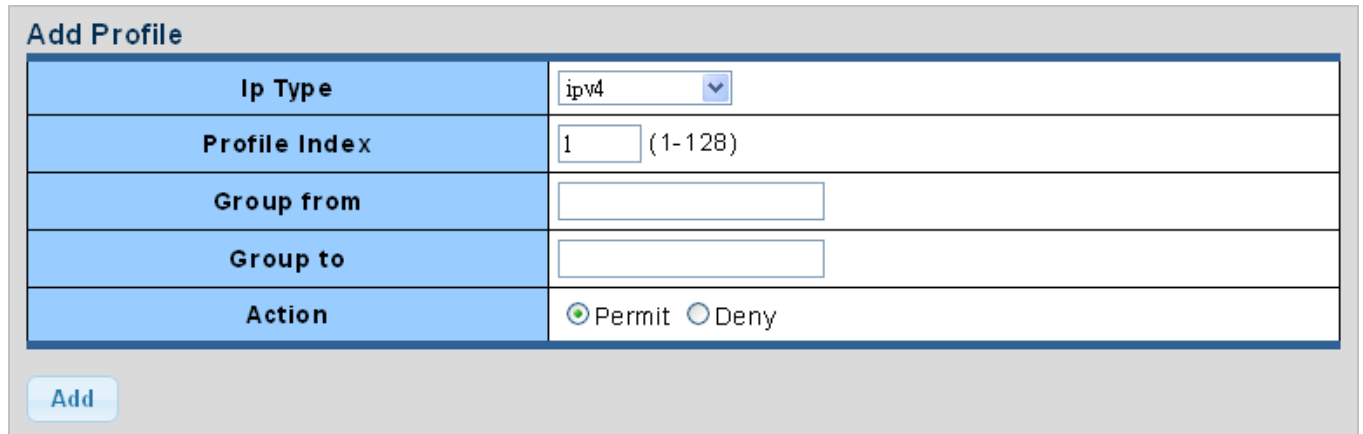

**Figure 4-7-36** Add Profile Setting Page Screenshot

The page includes the following fields:

Object	Description	
• <b>IP Type</b>	Select IPv4 or IPv6 for this drop down list	
• <b>Profile Index</b>	Indicates the ID of this particular profile	
• <b>Group from</b>	Specifies multicast groups to include in the profile. Specify a multicast group range by entering a start IP address.	
• <b>Group to</b>	Specifies multicast groups to include in the profile. Specify a multicast group range by entering an end IP address.	
• <b>Action</b>	Sets the access mode of the profile; either <b>permit</b> or <b>deny</b> .	
	- <b>Permit</b>	Multicast join reports are processed when a multicast group falls within the controlled range.
	- <b>Deny</b>	When the access mode is set to, multicast join reports are only processed when the multicast group is not in the controlled range.

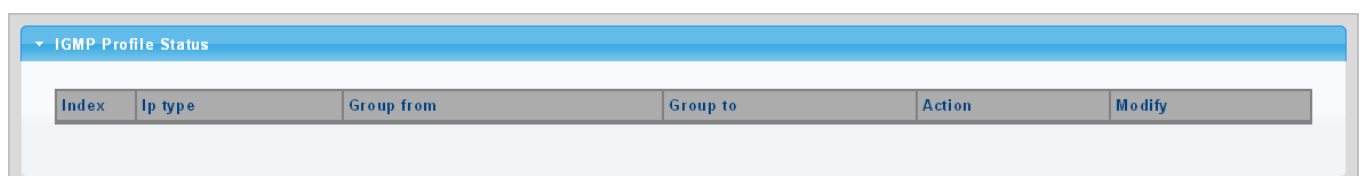

#### Buttons

: Click to add multicast profile entry.



**Figure 4-7-37** IGMP/MLD Profile Status Page Screenshot

The page includes the following fields:

Object	Description
• <b>Index</b>	Displays the current index
• <b>IP Type</b>	Displays the current IP Type
• <b>Group from</b>	Displays the current group from
• <b>Group to</b>	Displays the current group to
• <b>Action</b>	Displays the current action
• <b>Modify</b>	Click  to edit parameter.  Click  to delete the MLD/IGMP profile entry.

### 4.7.7.2 IGMP Filter Setting

The Filter Setting and Status screens in [Figure 4-7-38](#) & [Figure 4-7-39](#) appear.

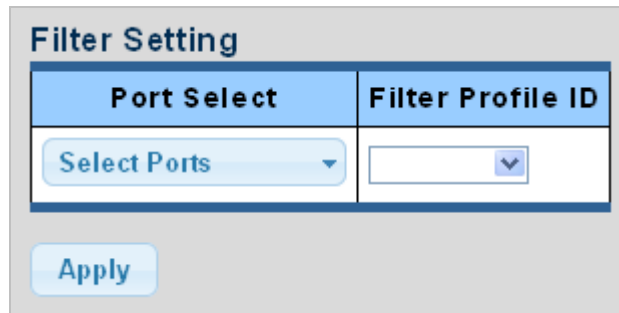

**Figure 4-7-38** Filter Setting Page Screenshot

The page includes the following fields:

Object	Description
<ul style="list-style-type: none"> <li>• <b>Port Select</b></li> </ul>	Select port number for this drop down list
<ul style="list-style-type: none"> <li>• <b>Filter Profile ID</b></li> </ul>	Select filter profile ID for this drop down list

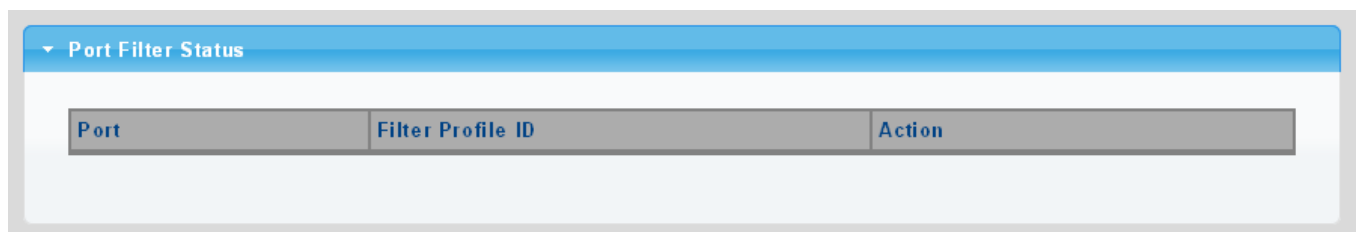

#### Buttons

: Click to apply changes.



**Figure 4-7-39** Port Filter Status Page Screenshot

The page includes the following fields:

Object	Description
<ul style="list-style-type: none"> <li>• <b>Port</b></li> </ul>	Displays the current port
<ul style="list-style-type: none"> <li>• <b>Filter Profile ID</b></li> </ul>	Displays the current filter profile ID
<ul style="list-style-type: none"> <li>• <b>Action</b></li> </ul>	Click  to display detail profile parameter  Click  to delete the IGMP filter profile entry

### 4.7.7.3 MLD Filter Setting

The Filter Setting and Status screens in [Figure 4-7-40](#) & [Figure 4-7-41](#) appear.

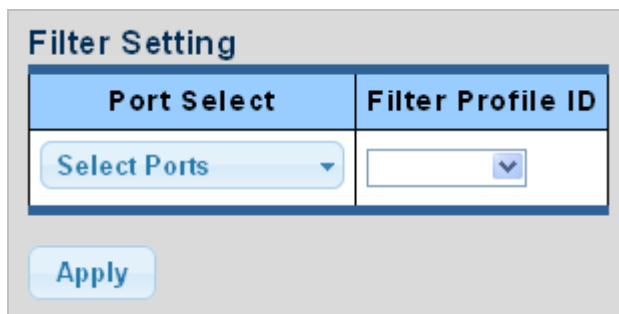

**Figure 4-7-40** Filter Setting Page Screenshot

The page includes the following fields:

Object	Description
• Port Select	Select port number for this drop down list
• Filter Profile ID	Select filter profile ID for this drop down list

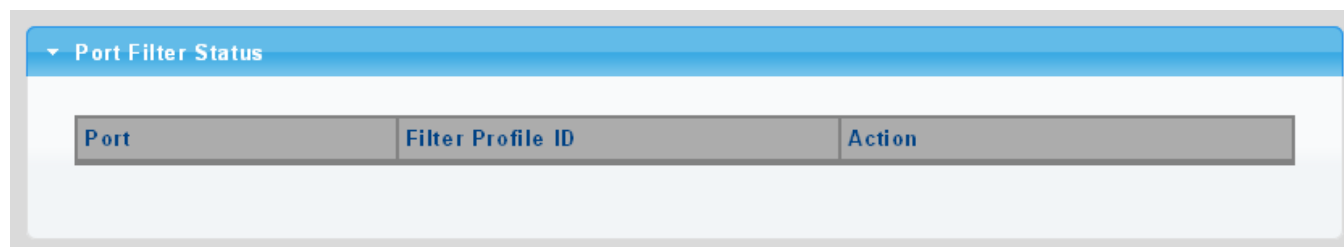

#### Buttons

: Click to apply changes.



**Figure 4-7-41** Port Filter Status Page Screenshot

The page includes the following fields:

Object	Description
• Port	Displays the current port
• Filter Profile ID	Displays the current filter profile ID
• Action	Click  to display detail profile parameter Click  to delete the MLD filter profile entry

## 4.8 Quality of Service

### 4.8.1 Understanding QoS

Quality of Service (QoS) is an advanced traffic prioritization feature that allows you to establish control over network traffic. QoS enables you to assign various grades of network service to different types of traffic, such as multi-media, video, protocol-specific, time critical, and file-backup traffic.

QoS reduces bandwidth limitations, delay, loss, and jitter. It also provides increased reliability for delivery of your data and allows you to prioritize certain applications across your network. You can define exactly how you want the switch to treat selected applications and types of traffic.

You can use QoS on your system to:

- Control a wide variety of network traffic by:
- Classifying traffic based on packet attributes.
- Assigning priorities to traffic (for example, to set higher priorities to time-critical or business-critical applications).
- Applying security policy through traffic filtering.
- Provide predictable throughput for multimedia applications such as video conferencing or voice over IP by minimizing delay and jitter.
- Improve performance for specific types of traffic and preserve performance as the amount of traffic grows.
- Reduce the need to constantly add bandwidth to the network.
- Manage network congestion.

To implement QoS on your network, you need to carry out the following actions:

1. Define a service level to determine the priority that will be applied to traffic.
2. Apply a classifier to determine how the incoming traffic will be classified and thus treated by the Switch.
3. Create a QoS profile which associates a service level and a classifier.
4. Apply a QoS profile to a port(s).

The **QoS** page of the Industrial Managed Switch contains three types of QoS mode - the **802.1p** mode, **DSCP** mode or **Port-base** mode can be selected. Both the three mode rely on predefined fields within the packet to determine the output queue.

- **802.1p Tag Priority Mode** –The output queue assignment is determined by the IEEE 802.1p VLAN priority tag.
- **IP DSCP Mode** - The output queue assignment is determined by the TOS or DSCP field in the IP packets.
- **Port-Base Priority Mode** – Any packet received from the specify high priority port will treated as a high priority packet.

The Industrial Managed Switch supports **eight priority level** queue, the queue service rate is based on the **WRR(Weight Round Robin)** and **WFQ (Weighted Fair Queuing)** alorithm. The WRR ratio of high-priority and low-priority can be set to “**4:1** and **8:1**.”

## 4.8.2 General

### 4.8.2.1 QoS Properties

The QoS Global Setting and Information screen in [Figure 4-8-1](#) & [Figure 4-8-2](#) appear.

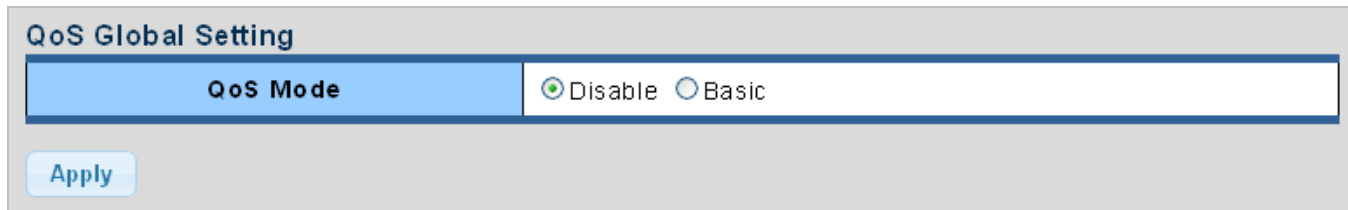

Figure 4-8-1 QoS Global Setting Page Screenshot

The page includes the following fields:

Object	Description
• QoS Mode	Enable or disable QoS mode

#### Buttons



: Click to apply changes.

#### ■ QoS Information

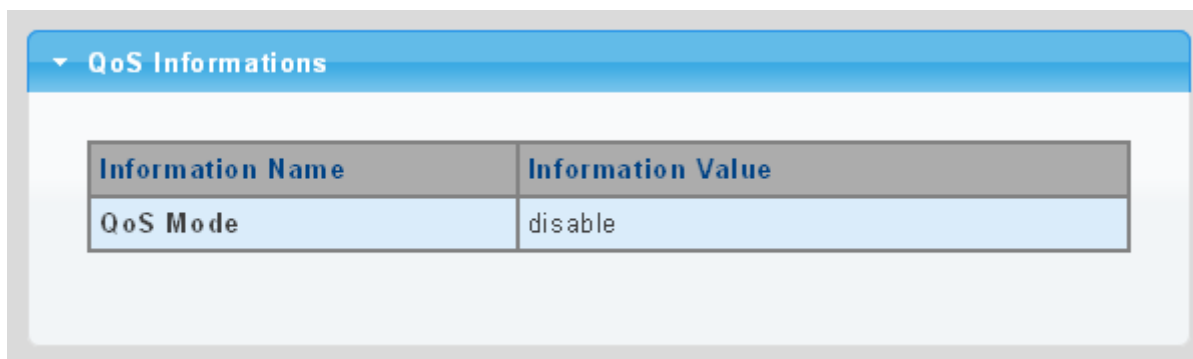

Figure 4-8-2 QoS Information Page Screenshot

The page includes the following fields:

Object	Description
• QoS Mode	Displays the current QoS mode

### 4.8.2.2 QoS Port Settings

The QoS Port Settings and Status screen in [Figure 4-8-2](#) & [Figure 4-8-3](#) appear.

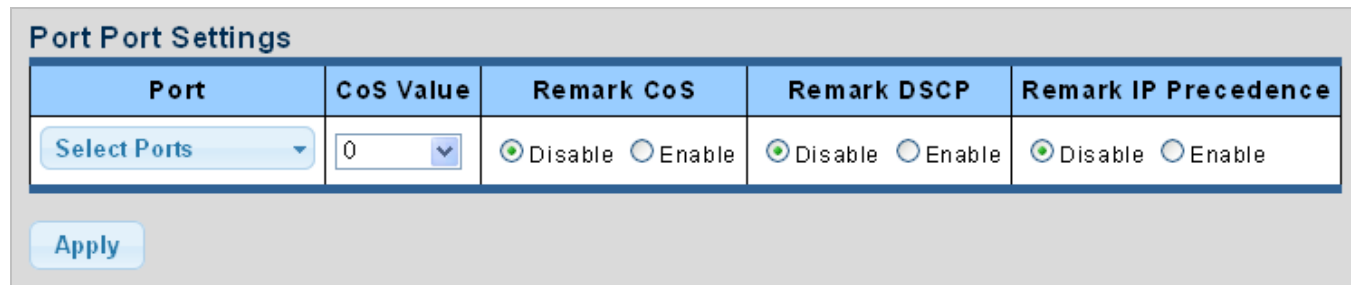

Port	CoS Value	Remark CoS	Remark DSCP	Remark IP Precedence
Select Ports	0	<input checked="" type="radio"/> Disable <input type="radio"/> Enable	<input checked="" type="radio"/> Disable <input type="radio"/> Enable	<input checked="" type="radio"/> Disable <input type="radio"/> Enable

Apply

Figure 4-8-2 QoS Port Setting Page Screenshot

The page includes the following fields:

Object	Description
• Port Select	Select port number for this drop down list
• CoS Value	Select CoS value for this drop down list
• Remark CoS	Disable or enable remark CoS
• Remark DSCP	Disable or enable remark DSCP
• Remark IP Precedence	Disable or enable remark IP Precedence

#### Buttons

: Click to apply changes.

#### ■ QoS Port Status

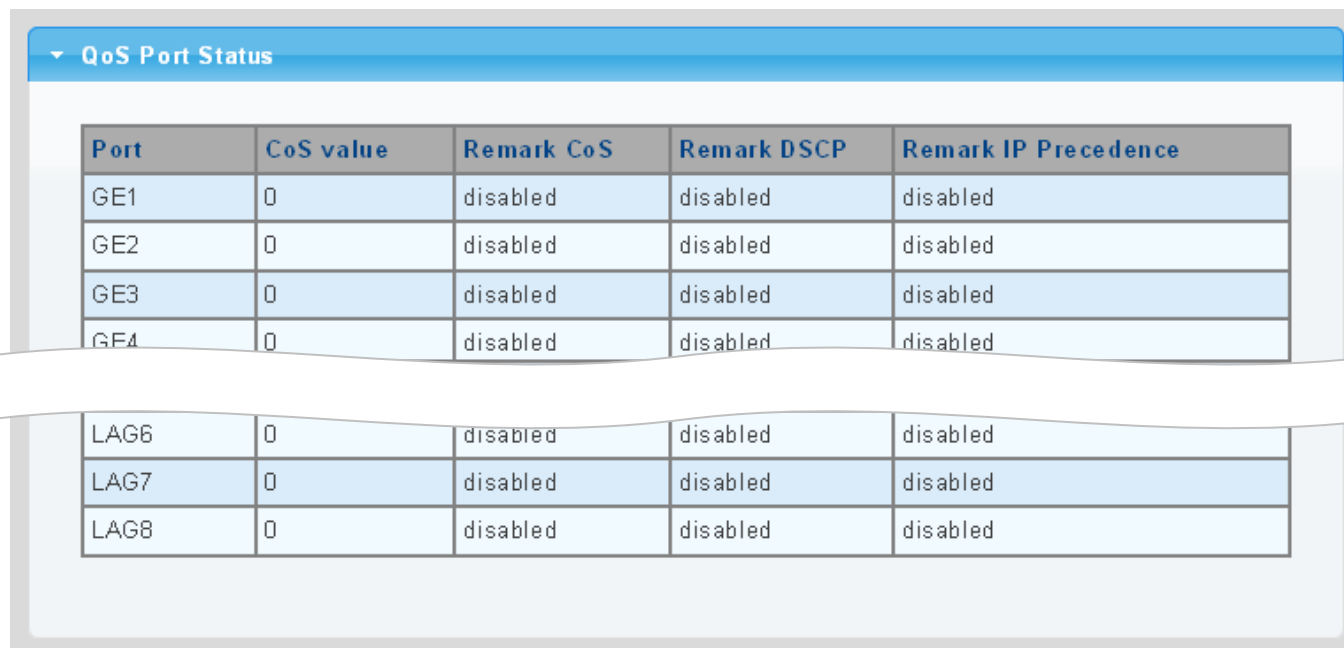

Port	CoS value	Remark CoS	Remark DSCP	Remark IP Precedence
GE1	0	disabled	disabled	disabled
GE2	0	disabled	disabled	disabled
GE3	0	disabled	disabled	disabled
GE4	0	disabled	disabled	disabled
LAG6	0	disabled	disabled	disabled
LAG7	0	disabled	disabled	disabled
LAG8	0	disabled	disabled	disabled

Figure 4-8-3 QoS Port Status Page Screenshot



The page includes the following fields:

Object	Description
• Port	The switch port number of the logical port
• CoS Value	Displays the current CoS value
• Remark CoS	Displays the current remark CoS
• Remark DSCP	Displays the current remark DSCP
• Remark IP Precedence	Displays the current remark IP precedence

### 4.8.2.3 Queue Settings

The Queue Table and Information screens in [Figure 4-8-4](#) & [Figure 4-8-5](#) appear.

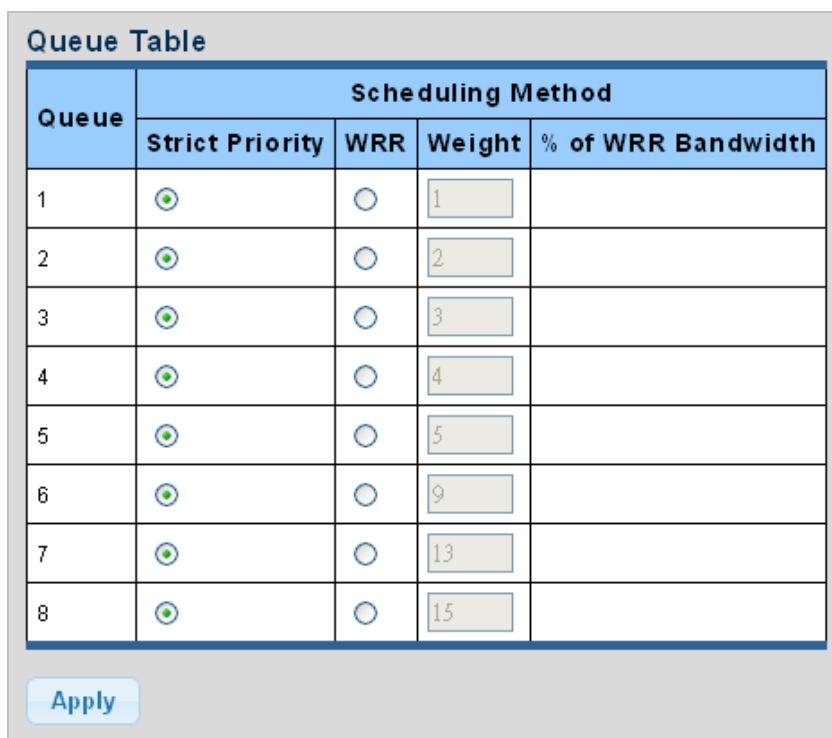

Figure 4-8-4 Queue Table Page Screenshot

The page includes the following fields:

Object	Description
• Queue	Displays the current queue ID
• Strict Priority	Controls whether the scheduler mode is "Strict Priority" on this switch port
• WRR	Controls whether the scheduler mode is "Weighted" on this switch port
• Weight	Controls the weight for this queue. This value is restricted to 1-100. This parameter is only shown if "Scheduler Mode" is set to "Weighted".
• % of WRR Bandwidth	Displays the current bandwidth for each queue

**Buttons**

**Apply**: Click to apply changes.

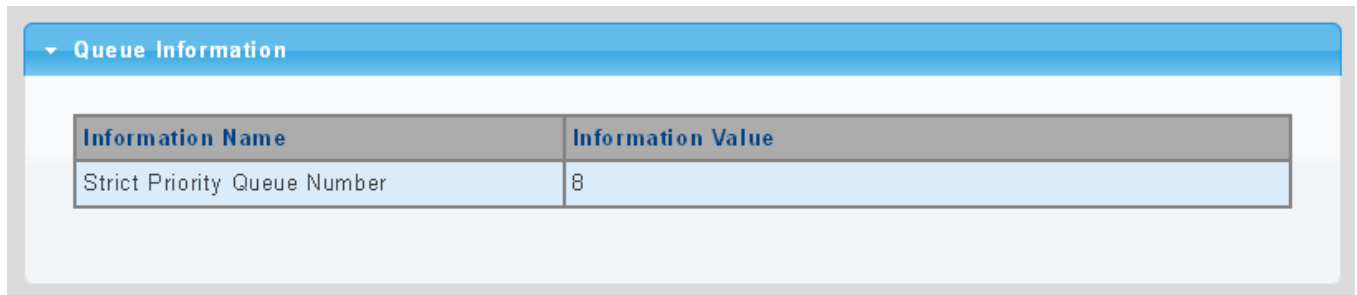

**Figure 4-8-5** Queue Information Page Screenshot

The page includes the following fields:

Object	Description
• <b>Information Name</b>	Displays the current queue method information
• <b>Information Value</b>	Displays the current queue value information

**4.8.2.4 CoS Mapping**

The CoS to Queue and Queue to CoS Mapping screens in [Figure 4-8-6](#) & [Figure 4-8-7](#) appear.

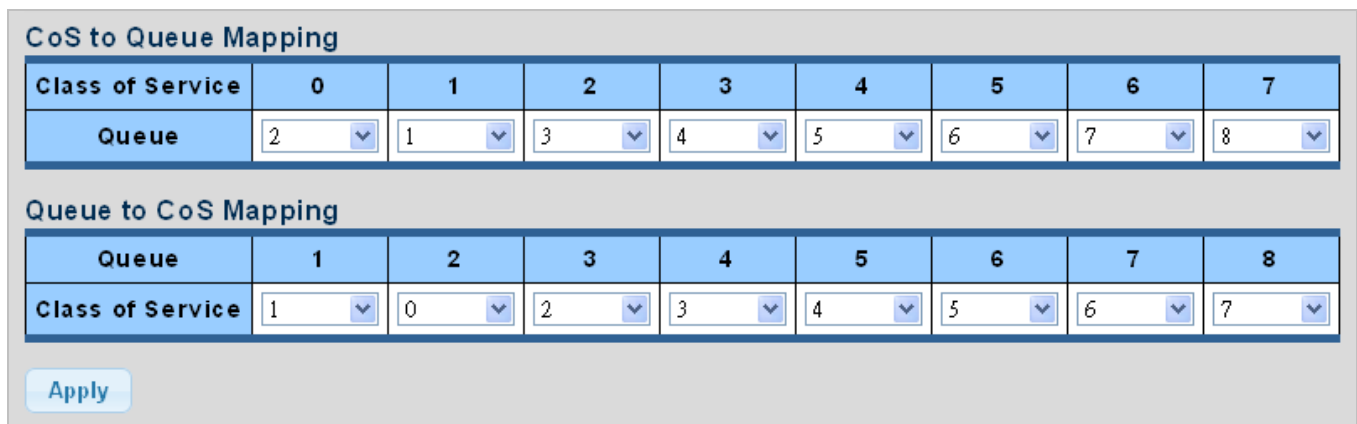

**Figure 4-8-6** CoS to Queue and Queue to CoS Mapping Page Screenshot

The page includes the following fields:

Object	Description
• <b>Queue</b>	Select Queue value for this drop down list
• <b>Class of Service</b>	Select CoS value for this drop down list

**Buttons**

: Click to apply changes.

■ **CoS Mapping**

▼ CoS mapping

CoS	Mapping to Queue
0	2
1	1
2	3
3	4
4	5
5	6
6	7
7	8

Queue	Mapping to CoS
1	1
2	0
3	2
4	3
5	4
6	5
7	6
8	7

**Figure 4-8-7** CoS Mapping Page Screenshot

The page includes the following fields:

Object	Description
• <b>CoS</b>	Displays the current CoS value
• <b>Mapping to Queue</b>	Displays the current mapping to queue
• <b>Queue</b>	Displays the current queue value
• <b>Mapping to CoS</b>	Displays the current mapping to CoS

### 4.8.2.5 DSCP Mapping

The DSCP to Queue and Queue to DSCP Mapping screens in [Figure 4-8-8](#) & [Figure 4-8-9](#) appear.

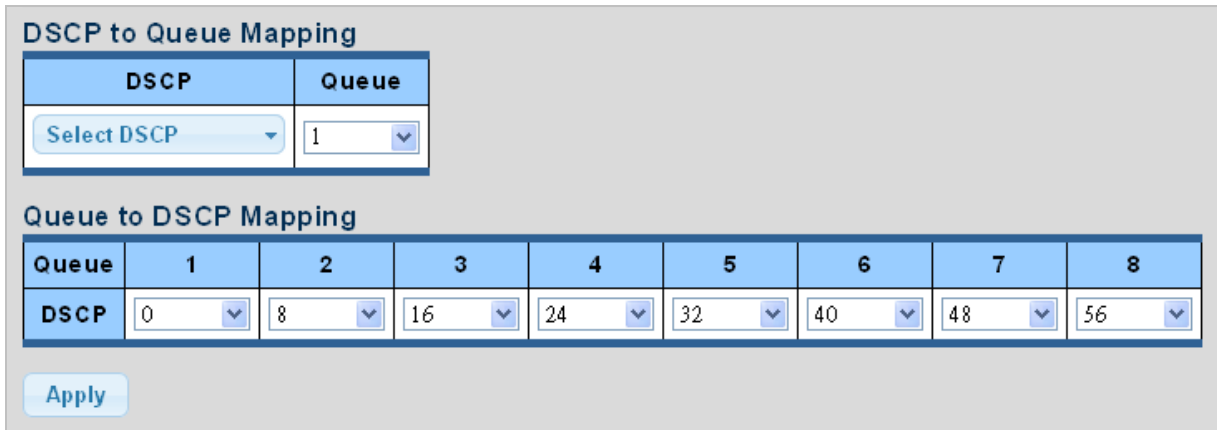

**Figure 4-8-8** DSCP to Queue and Queue to DSCP Mapping Page Screenshot

The page includes the following fields:

Object	Description
• Queue	Select Queue value for this drop down list
• DSCP	Select DSCP value for this drop down list

#### Buttons

: Click to apply changes.

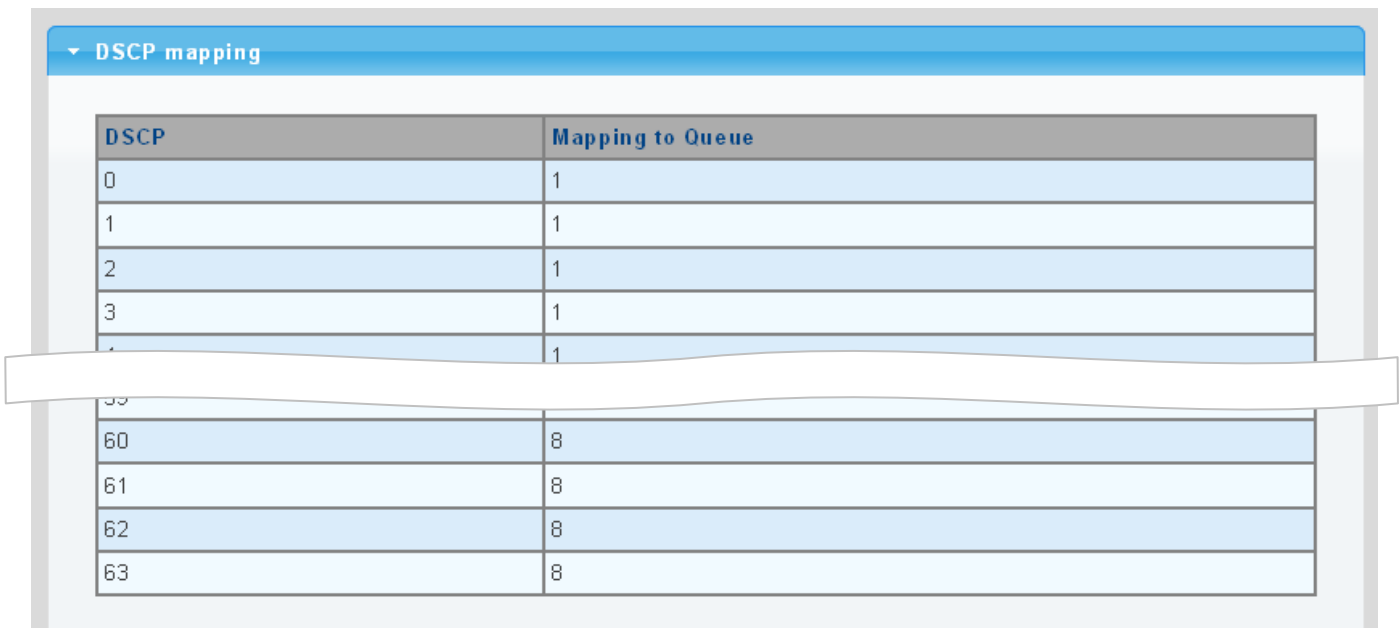

DSCP	Mapping to Queue
0	1
1	1
2	1
3	1
4	1
5	1
6	1
7	1
8	1
9	1
10	1
11	1
12	1
13	1
14	1
15	1
16	1
17	1
18	1
19	1
20	1
21	1
22	1
23	1
24	1
25	1
26	1
27	1
28	1
29	1
30	1
31	1
32	1
33	1
34	1
35	1
36	1
37	1
38	1
39	1
40	1
41	1
42	1
43	1
44	1
45	1
46	1
47	1
48	1
49	1
50	1
51	1
52	1
53	1
54	1
55	1
56	1
57	1
58	1
59	1
60	8
61	8
62	8
63	8

Queue	Mapping to DSCP
1	0
2	8
3	16
4	24
5	32
6	40
7	48
8	56

Figure 4-8-9 DSCP Mapping Page Screenshot

The page includes the following fields:

Object	Description
• <b>DSCP</b>	Displays the current CoS value
• <b>Mapping to Queue</b>	Displays the current mapping to queue
• <b>Queue</b>	Displays the current queue value
• <b>Mapping to DSCP</b>	Displays the current mapping to DSCP

#### 4.8.2.6 IP Precedence Mapping

The IP Precedence to Queue and Queue to IP Precedence Mapping screens in [Figure 4-8-10](#) & [Figure 4-8-11](#) appear.

**IP Precedence to Queue Mapping**

IP Precedence	0	1	2	3	4	5	6	7
Queue	1 ▾	2 ▾	3 ▾	4 ▾	5 ▾	6 ▾	7 ▾	8 ▾

**Queue to IP Precedence Mapping**

Queue	1	2	3	4	5	6	7	8
IP Precedence	0 ▾	1 ▾	2 ▾	3 ▾	4 ▾	5 ▾	6 ▾	7 ▾

Apply

Figure 4-8-10 IP Precedence to Queue and Queue to IP Precedence Mapping Page Screenshot

The page includes the following fields:

Object	Description
• Queue	Select Queue value for this drop down list
• IP Precedence	Select IP Precedence value for this drop down list

**Buttons**

: Click to apply changes.

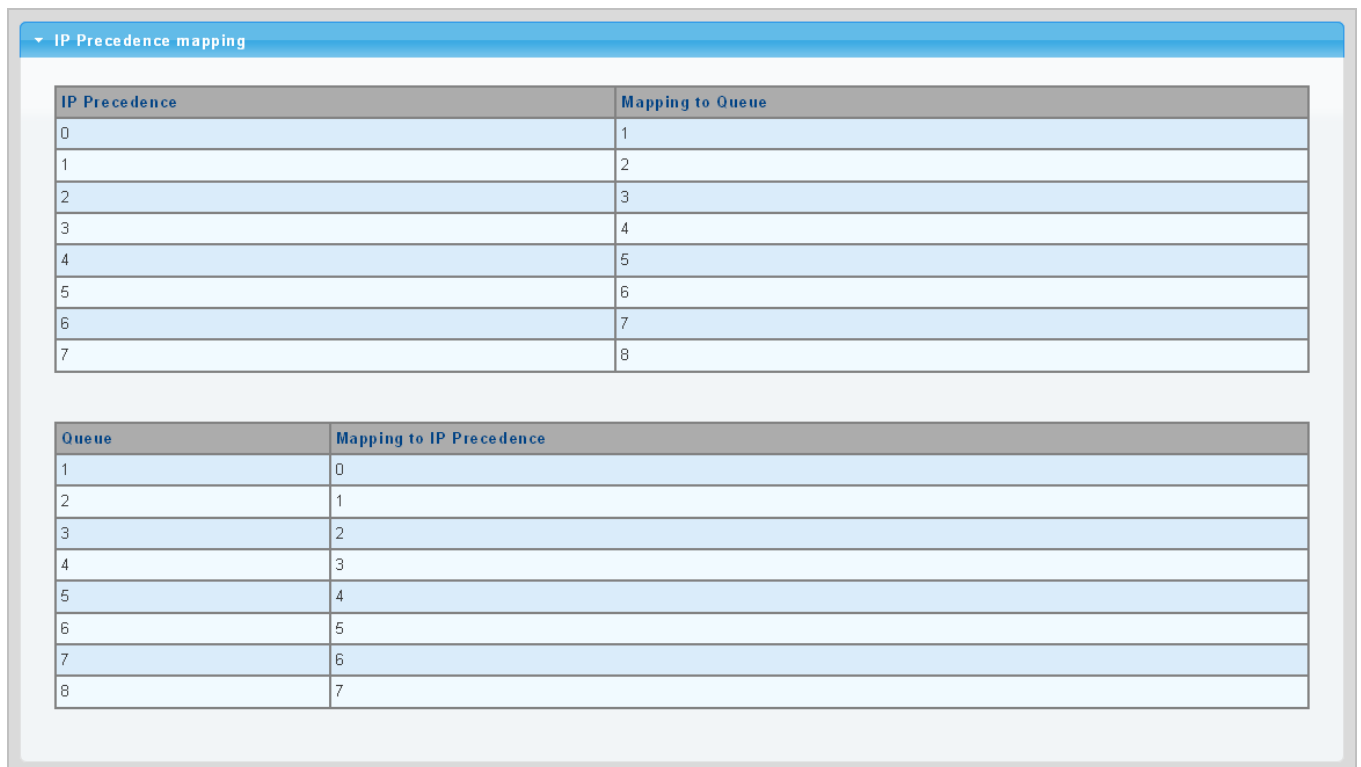

Figure 4-8-11 IP Precedence Mapping Page Screenshot

The page includes the following fields:

Object	Description
• IP Precedence	Displays the current CoS value
• Mapping to Queue	Displays the current mapping to queue
• Queue	Displays the current queue value
• Mapping to IP Precedence	Displays the current mapping to IP Precedence

### 4.8.3 QoS Basic Mode

#### 4.8.3.1 Global Settings

The Basic Mode Global Settings and QoS Information screen in [Figure 4-8-12](#) & [Figure 4-8-13](#) appear.

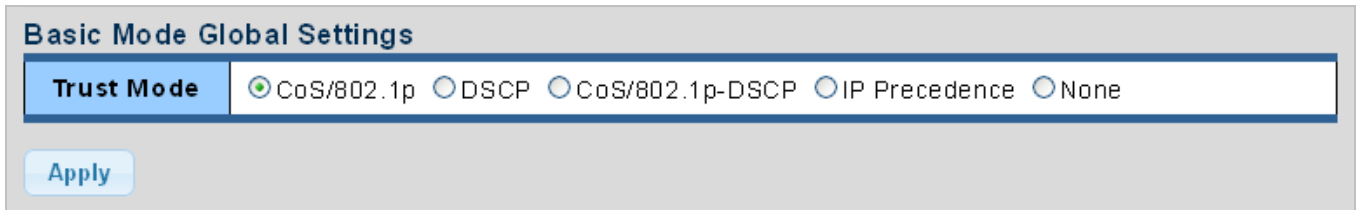

**Figure 4-8-12** Basic Mode Global Settings Page Screenshot

The page includes the following fields:

Object	Description
• Trust Mode	Set the QoS mode

#### Buttons



: Click to apply changes.

#### ■ QoS Information

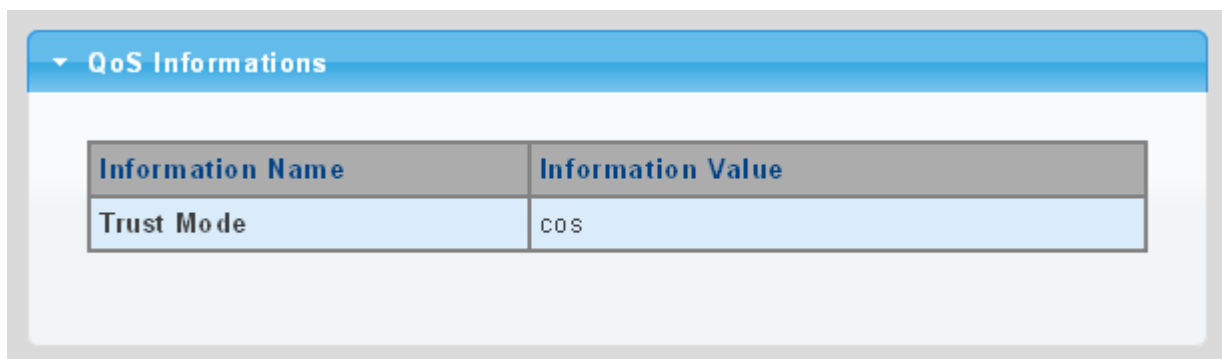

**Figure 4-8-13** QoS Information Page Screenshot

The page includes the following fields:

Object	Description
• Trust Mode	Displays the current QoS mode

### 4.8.3.2 Port Settings

The QoS Port Setting and Status screen in [Figure 4-8-14](#) & [Figure 4-8-15](#) appear.

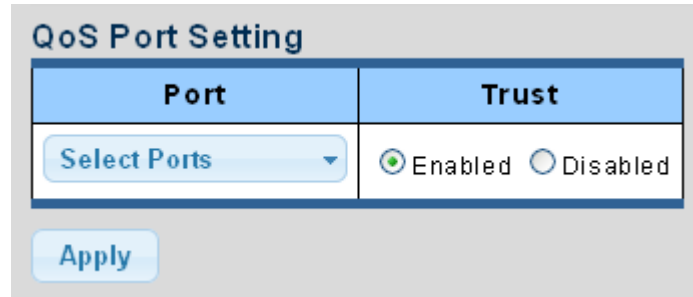

**Figure 4-8-14** Basic Mode Global Settings Page Screenshot

The page includes the following fields:

Object	Description
• Port	Select port number for this drop down list
• Trust Mode	Enable or disable the trust mode

#### Buttons

: Click to apply changes.

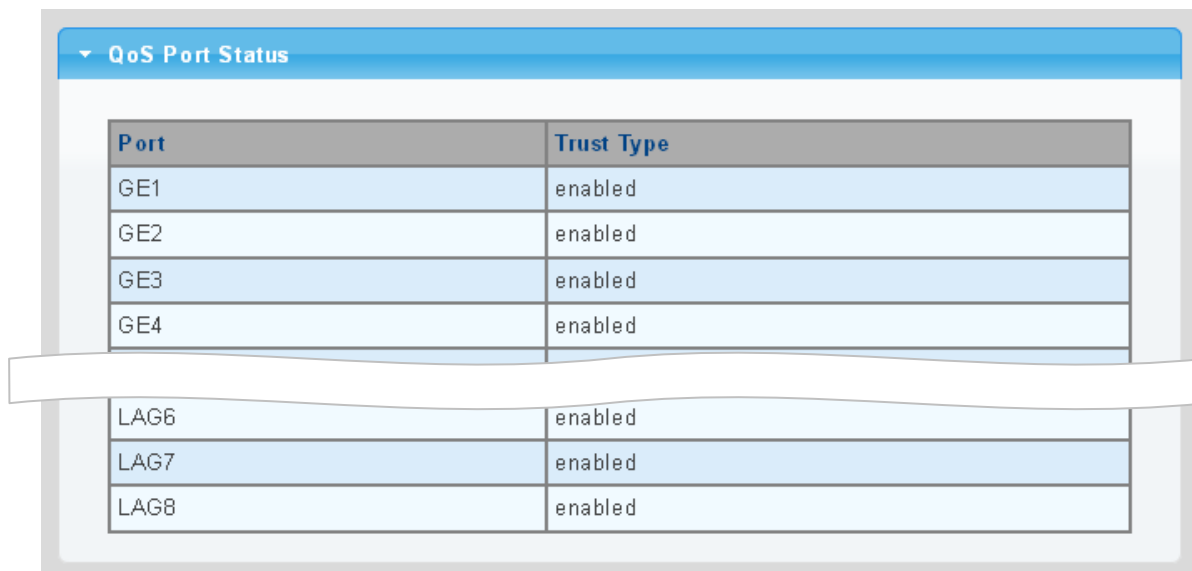

**Figure 4-8-15** QoS Port Status Page Screenshot

The page includes the following fields:

Object	Description
• Port	The switch port number of the logical port
• Trust Mode	Displays the current trust type



## 4.8.4 Rate Limit

Configure the switch port rate limit for the switch port on this page.

### 4.8.4.1 Ingress Bandwidth Control

This page provides to select the ingress bandwidth preamble. The Ingress Bandwidth Control Setting and Status screens in [Figure 4-8-16](#) & [Figure 4-8-17](#) appear.

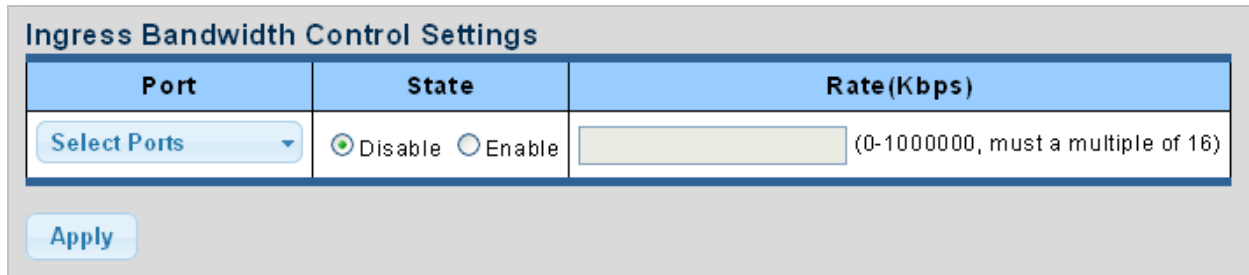

Port	State	Rate(Kbps)
Select Ports	<input checked="" type="radio"/> Disable <input type="radio"/> Enable	<input type="text"/> (0-1000000, must a multiple of 16)

Apply

Figure 4-8-16 Ingress Bandwidth Control Settings Page Screenshot

The page includes the following fields:

Object	Description
• Port	Select port number from this drop-down list
• State	Enable or disable the port rate policer. The default value is "Disabled".
• Rate (Kbps)	Configures the rate for the port policer. The default value is "unlimited". Valid values are in the range 0 to 1000000.

#### Buttons

: Click to apply changes.

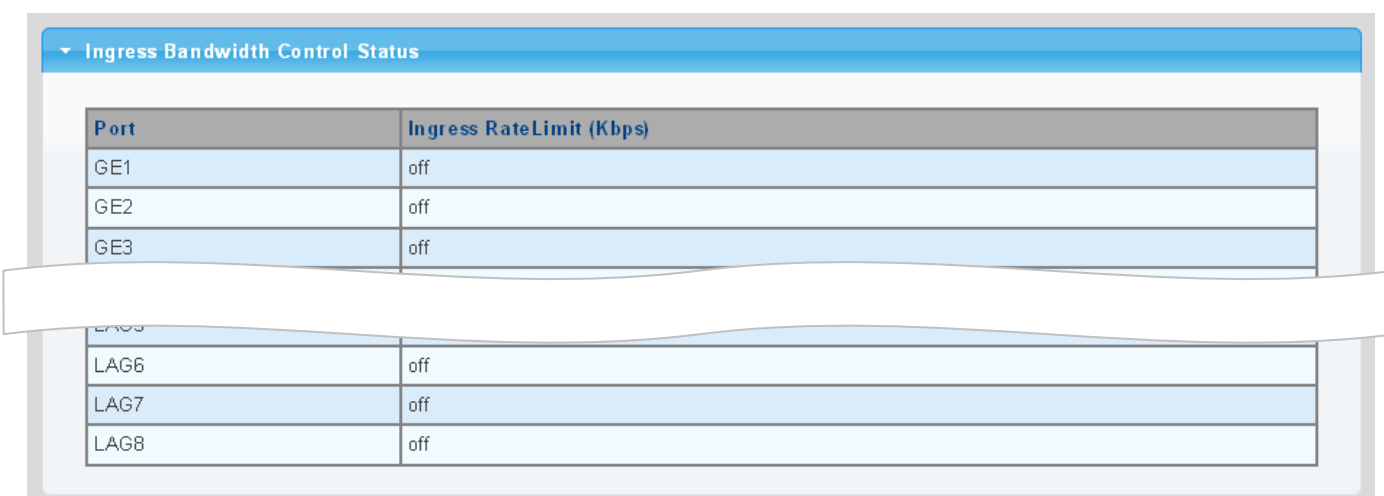

Port	Ingress RateLimit (Kbps)
GE1	off
GE2	off
GE3	off
LAG6	off
LAG7	off
LAG8	off

Figure 4-8-17 Ingress Bandwidth Control Status Page Screenshot

The page includes the following fields:

Object	Description
• Port	The switch port number of the logical port
• Ingress Rate Limit (Kbps)	Displays the current ingress rate limit

#### 4.8.4.2 Egress Bandwidth Control

This page provides to select the egress bandwidth preamble. The Egress Bandwidth Control Setting and Status screens in Figure 4-8-18 & Figure 4-8-19 appear.

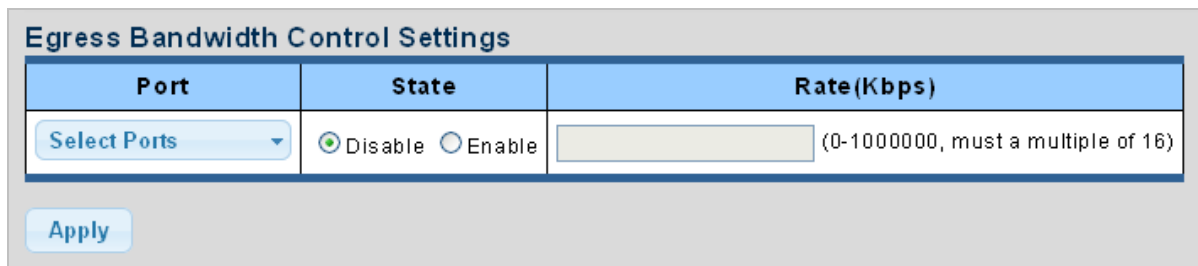

The screenshot shows the 'Egress Bandwidth Control Settings' page. It features a table with three columns: 'Port', 'State', and 'Rate(Kbps)'. The 'Port' column contains a dropdown menu labeled 'Select Ports'. The 'State' column has radio buttons for 'Disable' (selected) and 'Enable'. The 'Rate(Kbps)' column has a text input field with a placeholder '(0-1000000, must a multiple of 16)'. Below the table is an 'Apply' button.

Figure 4-8-18 Egress Bandwidth Control Settings Page Screenshot

The page includes the following fields:

Object	Description
• Port	Select port number for this drop down list
• State	Enable or disable the port rate policer. The default value is "Disabled".
• Rate (Kbps)	Configures the rate for the port policer. The default value is "unlimited". Valid values are in the range 0 to 1000000.

#### Buttons

: Click to apply changes.

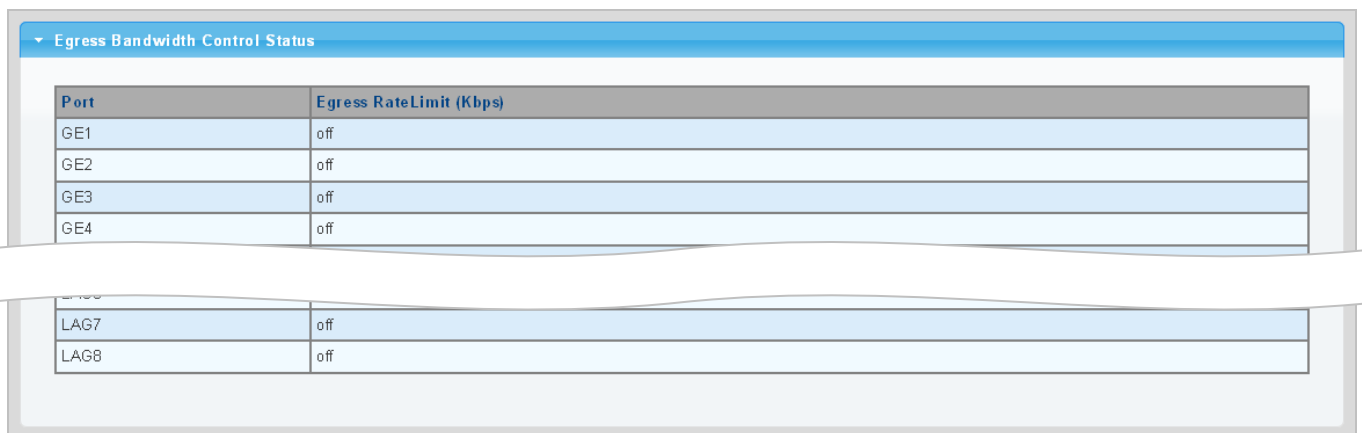

The screenshot shows the 'Egress Bandwidth Control Status' page. It displays a table with two columns: 'Port' and 'Egress RateLimit (Kbps)'. The table lists several ports: GE1, GE2, GE3, GE4, LAG7, and LAG8. All listed ports have a status of 'off'.

Port	Egress RateLimit (Kbps)
GE1	off
GE2	off
GE3	off
GE4	off
LAG7	off
LAG8	off

Figure 4-8-19 Egress Bandwidth Control Status Page Screenshot

The page includes the following fields:

Object	Description
• Port	The switch port number of the logical port
• Egress Rate Limit (Kbps)	Displays the current egress rate limit

### 4.8.4.3 Egress Queue

The Egress Queue Bandwidth Control Settings and Status screens in [Figure 4-8-20](#) & [Figure 4-8-21](#) appear.

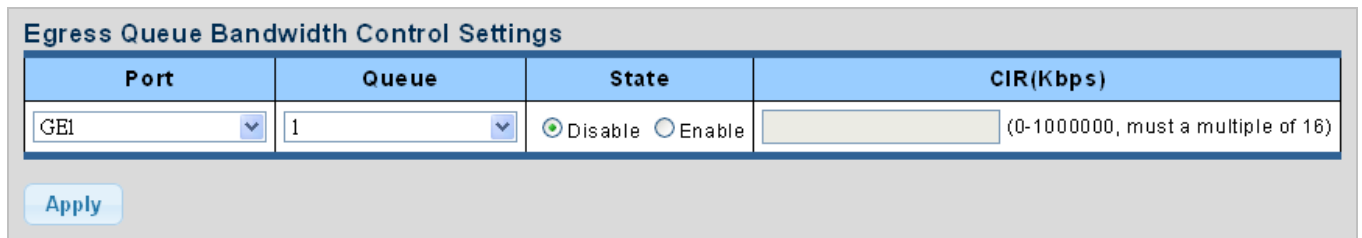

**Egress Queue Bandwidth Control Settings**

Port	Queue	State	CIR(Kbps)
GE1	1	<input checked="" type="radio"/> Disable <input type="radio"/> Enable	<input type="text"/> (0-1000000, must a multiple of 16)

**Figure 4-8-20** Egress Queue Bandwidth Settings Page Screenshot

The page includes the following fields:

Object	Description
• Port	Select port number for this drop down list
• Queue	Select queue number for this drop down list
• State	Enable or disable the port rate policer. The default value is "Disabled".
• CIR (Kbps)	Configure the CIR for the port policer. The default value is "unlimited". Valid values are in the range 0 to 1000000.

#### Buttons

: Click to apply changes.

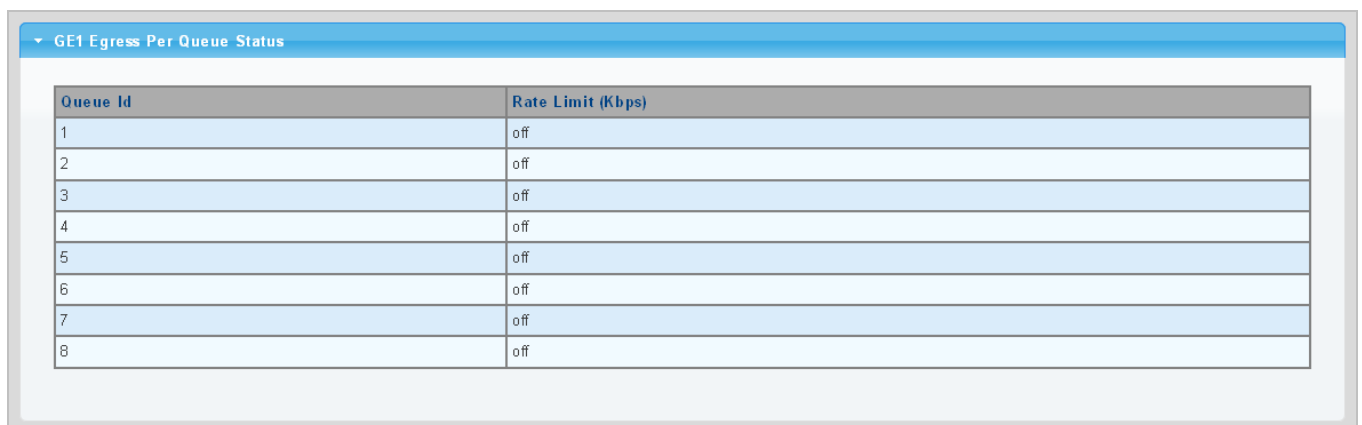

**GE1 Egress Per Queue Status**

Queue Id	Rate Limit (Kbps)
1	off
2	off
3	off
4	off
5	off
6	off
7	off
8	off

**Figure 4-8-21** Egress Queue Status Page Screenshot

The page includes the following fields:

Object	Description
• Queue ID	Displays the current queue ID
• Rate Limit (Kbps)	Displays the current rate limit

## 4.8.5 Voice VLAN

### 4.5.8.1 Introduction to Voice VLAN

Configure the switch port rate limit for the switch port on this page.

Voice VLAN is specially configured for the user voice data traffic. By setting a Voice VLAN and adding the ports of the connected voice equipments to Voice VLAN, the user will be able to configure QoS (Quality of service) service for voice data, and improve voice data traffic transmission priority to ensure the calling quality.

The switch can judge if the data traffic is the voice data traffic from specified equipment according to the source MAC address field of the data packet entering the port. The packet with the source MAC address complying with the system defined voice equipment **OUI (Organizationally Unique Identifier)** will be considered the voice data traffic and transmitted to the Voice VLAN.

The configuration is based on MAC address, acquiring a mechanism in which every voice equipment transmitting information through the network has got its unique MAC address. VLAN will trace the address belongs to specified MAC. By This means, VLAN allows the voice equipment always belong to Voice VLAN when relocated physically. The greatest advantage of the VLAN is the equipment can be automatically placed into Voice VLAN according to its voice traffic which will be transmitted at specified priority. Meanwhile, when voice equipment is physically relocated, it still belongs to the Voice VLAN without any further configuration modification, which is because it is based on voice equipment other than switch port.



Note

The Voice VLAN feature enables the voice traffic to forward on the Voice VLAN, and then the switch can be classified and scheduled to network traffic. **It is recommended there are two VLANs on a port** -- one for voice and one for data.



Note

Before connecting the IP device to the switch, **the IP phone should configure the voice VLAN ID correctly**. It should be configured through its own GUI.

### 4.8.5.2 Properties

The Voice VLAN feature enables voice traffic to forward on the Voice VLAN, and then the switch can be classified and scheduled to network traffic. It is recommended that there are two VLANs on a port -- one for voice, one for data.

Before connecting the IP device to the switch, the IP phone should configure the voice VLAN ID correctly. It should be configured through its own GUI. This page provides to select the ingress bandwidth preamble. The Ingress Bandwidth Control Setting/Status screen in [Figure 4-8-22](#) & [Figure 4-8-23](#) appears.

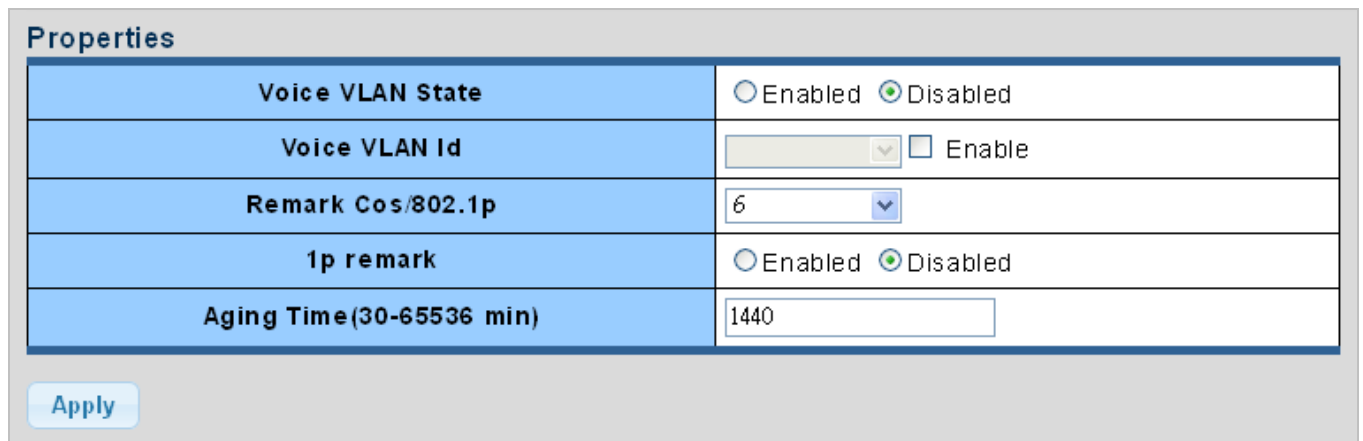

Properties	
Voice VLAN State	<input type="radio"/> Enabled <input checked="" type="radio"/> Disabled
Voice VLAN Id	<input type="text"/> <input type="checkbox"/> Enable
Remark Cos/802.1p	6
1p remark	<input type="radio"/> Enabled <input checked="" type="radio"/> Disabled
Aging Time(30-65536 min)	1440

Apply

Figure 4-8-22 Properties Page Screenshot

The page includes the following fields:

Object	Description
<ul style="list-style-type: none"> <li>• <b>Voice VLAN State</b></li> </ul>	<p>Indicates the Voice VLAN mode operation. We must disable MSTP feature before we enable Voice VLAN. It can avoid the conflict of ingress filter. Possible modes are:</p> <ul style="list-style-type: none"> <li>■ <b>Enabled</b>: Enable Voice VLAN mode operation.</li> <li>■ <b>Disabled</b>: Disable Voice VLAN mode operation</li> </ul>
<ul style="list-style-type: none"> <li>• <b>Voice VLAN ID</b></li> </ul>	<p>Indicates the Voice VLAN ID. It should be a unique VLAN ID in the system and cannot equal each port PVID. It is conflict configuration if the value equal management VID, MVR VID, PVID, etc.</p> <p>The allowed range is 1 to 4095.</p>
<ul style="list-style-type: none"> <li>• <b>Remark CoS/802.1p</b></li> </ul>	<p>Select 802.1p value for this drop down list</p>
<ul style="list-style-type: none"> <li>• <b>1p remark</b></li> </ul>	<p>Enable or disable 802.1p remark</p>
<ul style="list-style-type: none"> <li>• <b>Aging Time (30-65536 min)</b></li> </ul>	<p>The time after which a port is removed from the Voice VLAN when VoIP traffic is no longer received on the port.</p> <p>(\Default: <b>1440</b> minutes).</p>

#### Buttons

: Click to apply changes.

Voice VLAN State	
Information Name	Information Value
Voice VLAN State	disabled
Voice VLAN ID	none (disable)
Remark Cos/802.1p	6
1p Remark State	disabled
Aging	1440

Figure 4-8-23 Properites Page Screenshot

The page includes the following fields:

Object	Description
• Voice VLAN State	Displays the current voice VLAN state.
• Voice VLAN ID	Displays the current voice VLAN ID.
• Remark CoS/802.1p	Displays the current remark CoS/802.1p.
• 1p remark	Displays the current 1p remark.
• Aging	Displays the current aging time.

### 4.8.5.3 Telephony OUI MAC Setting

Configure VOICE VLAN OUI table on this Page. The Telephony OUI MAC Setting screens in [Figure 4-8-24](#) & [Figure 4-8-25](#) appear.

Voice VLAN OUI Setting	
OUI Address	<input type="text" value="00:00:00"/>
Description	<input type="text"/>

Figure 4-8-24 Voice VLAN OUI Settings Page Screenshot

The page includes the following fields:

Object	Description
<ul style="list-style-type: none"> <li><b>OUI Address</b></li> </ul>	<p>A telephony OUI address is a globally unique identifier assigned to a vendor by IEEE.</p> <p>It must be 6 characters long and the input format is "xx:xx:xx" (x is a hexadecimal digit).</p>
<ul style="list-style-type: none"> <li><b>Description</b></li> </ul>	User-defined text that identifies the VoIP devices

**Buttons**

 : Click to add voice VLAN OUI setting.

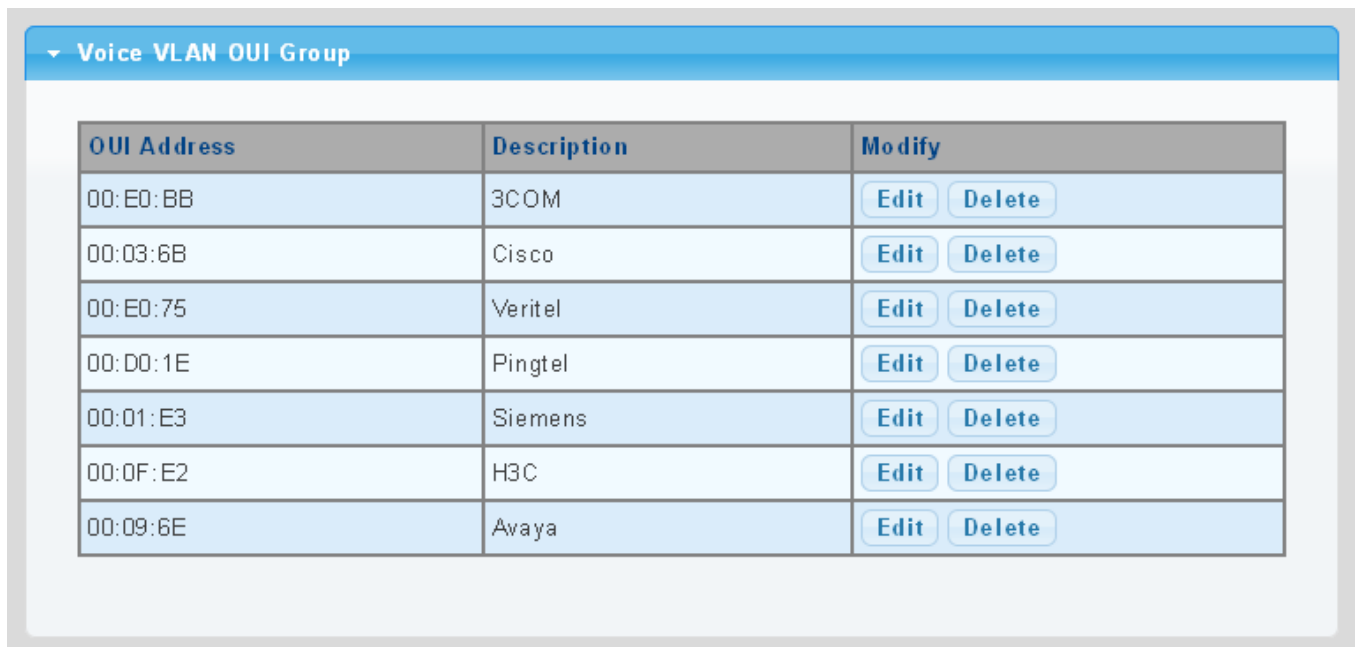



Figure 4-8-25 Voice VLAN OUI Group Page Screenshot

The page includes the following fields:

Object	Description
<ul style="list-style-type: none"> <li><b>OUI Address</b></li> </ul>	Displays the current OUI address
<ul style="list-style-type: none"> <li><b>Description</b></li> </ul>	Displays the current description
<ul style="list-style-type: none"> <li><b>Modify</b></li> </ul>	<p>Click  to edit voice VLAN OUI group parameter</p> <p>Click  to delete voice VLAN OUI group parameter</p>

### 4.8.5.4 Telephony OUI Port Setting

The Voice VLAN feature enables voice traffic forwarding on the Voice VLAN, then the switch can classify and schedule network traffic. It is recommended that there be two VLANs on a port - one for voice, one for data. Before connecting the IP device to the switch, the IP phone should configure the voice VLAN ID correctly. It should be configured through its own GUI. The Telephony OUI MAC Setting screens in [Figure 4-8-26](#) & [Figure 4-8-27](#) appear.

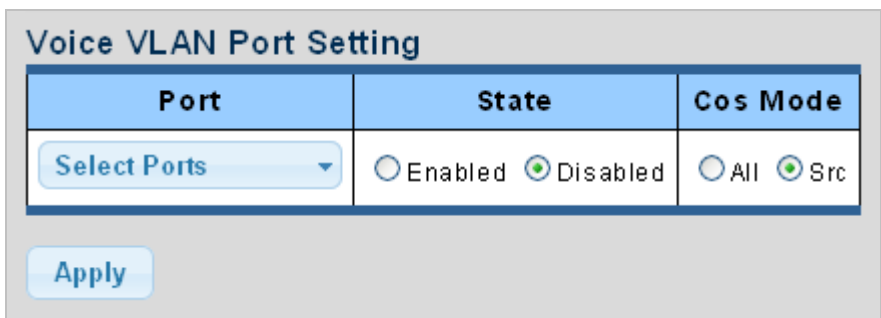

**Figure 4-8-26** Voice VLAN Port Setting Page Screenshot

The page includes the following fields:

Object	Description
• Port	Select port number for this drop down list
• State	Enable or disable the voice VLAN port setting. The default value is "Disabled".
• CoS Mode	Select the current CoS mode

#### Buttons

: Click to apply changes.

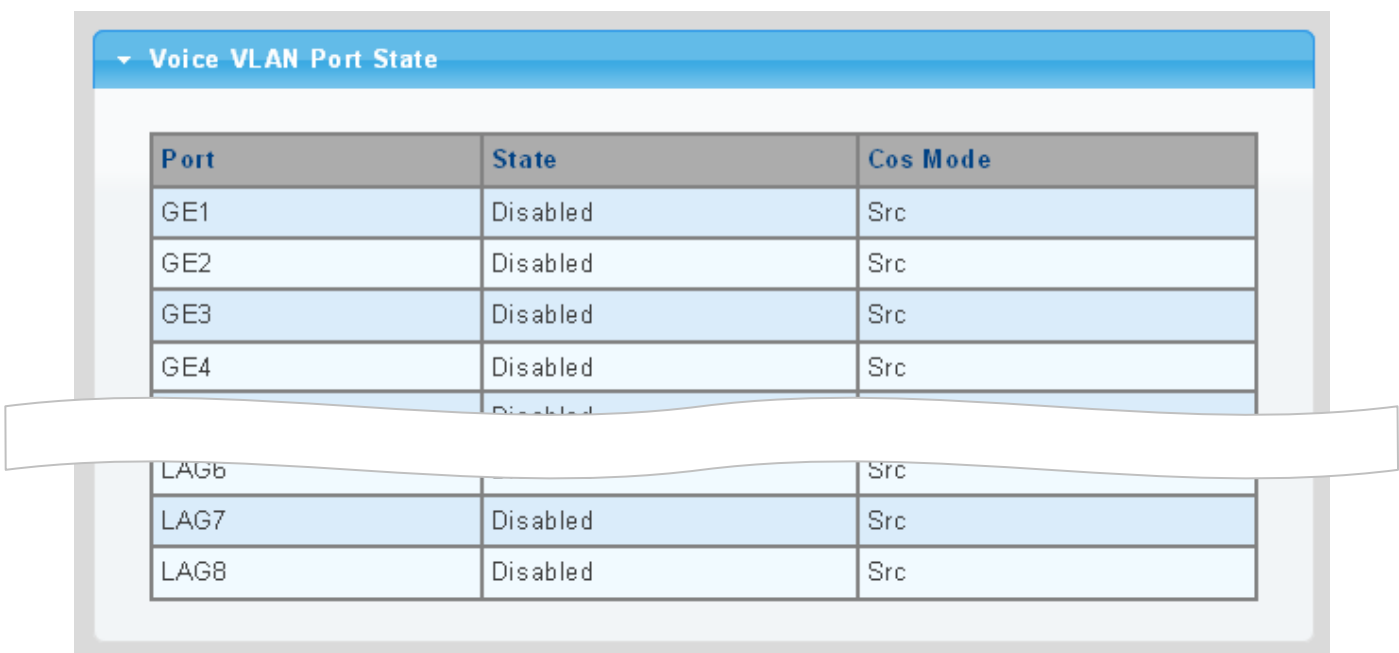

**Figure 4-8-27** Voice VLAN Port State Page Screenshot



The page includes the following fields:

Object	Description
• <b>Port</b>	The switch port number of the logical port
• <b>State</b>	Displays the current state
• <b>CoS Mode</b>	Displays the current CoS mode

## 4.9 Security

This section is to control the access of the Industrial Managed Switch, including the user access and management control.

The Security Page contains links to the following main topics:

- **802.1x**
- **Radius Server**
- **TACACS+ Server**
- **AAA**
- **Access**
- **Management Access Method**
- **DHCP Snooping**
- **Dynamic ARP Inspection**
- **IP Source Guard**
- **Port Security**
- **DoS**
- **Strom Control**

### 4.9.1 802.1X

#### Overview of 802.1X (Port-based) Authentication

In the 802.1X-world, the user is called the supplicant, the switch is the authenticator, and the RADIUS server is the authentication server. The switch acts as the man-in-the-middle, forwarding requests and responses between the supplicant and the authentication server. Frames sent between the supplicant and the switch are special 802.1X frames, known as **EAPOL (EAP over LANs)** frames. EAPOL frames encapsulate **EAP PDUs** (RFC3748). Frames sent between the switch and the RADIUS server are RADIUS packets. RADIUS packets also encapsulate EAP PDUs together with other attributes like the switch's IP address, name, and the supplicant's port number on the switch. EAP is very flexible, in that it allows for different authentication methods, like **MD5-Challenge**, **PEAP**, and **TLS**. The important thing is that the authenticator (the switch) doesn't need to know which authentication method the supplicant and the authentication server are using, or how many information exchange frames are needed for a particular method. The switch simply encapsulates the EAP part of the frame into the relevant type (EAPOL or RADIUS) and forwards it.

When authentication is complete, the RADIUS server sends a special packet containing a success or failure indication. Besides forwarding this decision to the supplicant, the switch uses it to open up or block traffic on the switch port connected to the supplicant.

#### Overview of User Authentication

It is allowed to configure the Industrial Managed Switch to authenticate users logging into the system for management access using local or remote authentication methods, such as telnet and Web browser. This Industrial Managed Switch provides secure network management access using the following options:

- Remote Authentication Dial-in User Service (RADIUS)
- Terminal Access Controller Access Control System Plus (TACACS+)
- Local user name and Privilege Level control

#### 4.9.1.1 Understanding IEEE 802.1X Port-based Authentication

The IEEE 802.1X standard defines a client-server-based access control and authentication protocol that restricts unauthorized clients from connecting to a LAN through publicly accessible ports. The authentication server authenticates each client connected to a switch port before making available any services offered by the switch or the LAN.

Until the client is authenticated, 802.1X access control allows only **Extensible Authentication Protocol over LAN (EAPOL)** traffic through the port to which the client is connected. After authentication is successful, normal traffic can pass through the port.

This section includes this conceptual information:

- Device Roles
- Authentication Initiation and Message Exchange
- Ports in Authorized and Unauthorized States

#### ■ Device Roles

With 802.1X port-based authentication, the devices in the network have specific roles as shown below.

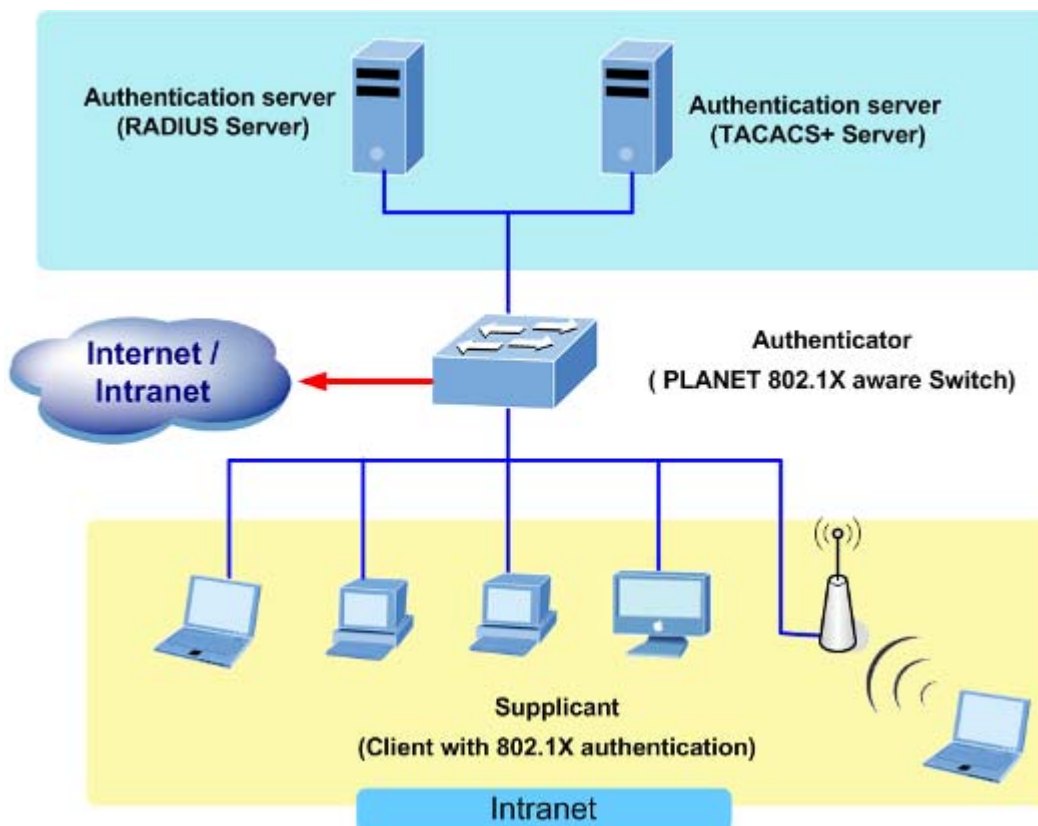

Figure 4-9-1

- **Client**—the device (workstation) that requests access to the LAN and switch services and responds to requests from the switch. The workstation must be running 802.1X-compliant client software such as that offered in the Microsoft Windows XP operating system. (The client is the *supplicant* in the IEEE 802.1X specification.)
- **Authentication server**—performs the actual authentication of the client. The authentication server validates the identity of the client and notifies the switch whether or not the client is authorized to access the LAN and switch services. Because the switch acts as the proxy, the authentication service is transparent to the client. In this release, the Remote Authentication Dial-In User Service (RADIUS) security system with **Extensible Authentication Protocol (EAP)** extensions is the only supported authentication server; it is available in Cisco Secure Access Control Server version 3.0. RADIUS operates in a client/server model in which secure authentication information is exchanged between the RADIUS server and one or more RADIUS clients.
- **Switch (802.1X device)**—controls the physical access to the network based on the authentication status of the client. The switch acts as an intermediary (proxy) between the client and the authentication server, requesting identity information from the client, verifying that information with the authentication server, and relaying a response to the client. The switch includes the RADIUS client, which is responsible for encapsulating and decapsulating the Extensible Authentication Protocol (EAP) frames and interacting with the authentication server. When the switch receives EAPOL frames and relays them to the authentication server, the Ethernet header is stripped and the remaining EAP frame is re-encapsulated in the RADIUS format. The EAP frames are not modified or examined during encapsulation, and the authentication server must support EAP within the native frame format. When the switch receives frames from the authentication server, the server's frame header is removed, leaving the EAP frame, which is then encapsulated for Ethernet and sent to the client.

#### ■ Authentication Initiation and Message Exchange

The switch or the client can initiate authentication. If you enable authentication on a port by using the **dot1x port-control auto** interface configuration command, the switch must initiate authentication when it determines that the port link state transitions from down to up. It then sends an EAP-request/identity frame to the client to request its identity (typically, the switch sends an initial identity/request frame followed by one or more requests for authentication information). Upon receipt of the frame, the client responds with an EAP-response/identity frame.

However, if during bootup, the client does not receive an EAP-request/identity frame from the switch, the client can initiate authentication by sending an EAPOL-start frame, which prompts the switch to request the client's identity



---

If 802.1X is not enabled or supported on the network access device, any EAPOL frames from the client are dropped. If the client does not receive an EAP-request/identity frame after three attempts to start authentication, the client transmits frames as if the port is in the authorized state. A port in the authorized state effectively means that the client has been successfully authenticated.

---

When the client supplies its identity, the switch begins its role as the intermediary, passing EAP frames between the client and the authentication server until authentication succeeds or fails. If the authentication succeeds, the switch port becomes authorized.

The specific exchange of EAP frames depends on the authentication method being used. "Figure 4-9-2" shows a message exchange initiated by the client using the One-Time-Password (OTP) authentication method with a RADIUS server.

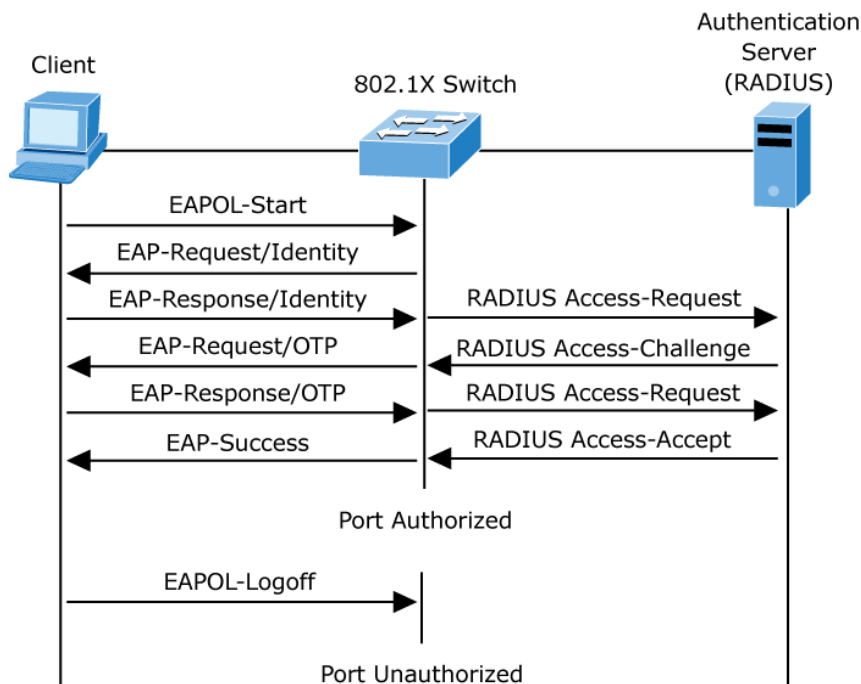

Figure 4-9-2 EAP Message Exchange

■ **Ports in Authorized and Unauthorized States**

The switch port state determines whether or not the client is granted access to the network. The port starts in the *unauthorized* state. While in this state, the port disallows all ingress and egress traffic except for 802.1X protocol packets. When a client is successfully authenticated, the port transitions to the *authorized* state, allowing all traffic for the client to flow normally.

If a client that does not support 802.1X is connected to an unauthorized 802.1X port, the switch requests the client's identity. In this situation, the client does not respond to the request, the port remains in the unauthorized state, and the client is not granted access to the network.

In contrast, when an 802.1X-enabled client connects to a port that is not running the 802.1X protocol, the client initiates the authentication process by sending the EAPOL-start frame. When no response is received, the client sends the request for a fixed number of times. Because no response is received, the client begins sending frames as if the port is in the authorized state

If the client is successfully authenticated (receives an Accept frame from the authentication server), the port state changes to authorized, and all frames from the authenticated client are allowed through the port. If the authentication fails, the port remains in the unauthorized state, but authentication can be retried. If the authentication server cannot be reached, the switch can retransmit the request. If no response is received from the server after the specified number of attempts, authentication fails, and network access is not granted.

When a client logs off, it sends an EAPOL-logoff message, causing the switch port to transition to the unauthorized state.

If the link state of a port transitions from up to down, or if an EAPOL-logoff frame is received, the port returns to the unauthorized state.

### 4.9.1.2 802.1X Setting

This page allows you to configure the IEEE 802.1X authentication system.

The IEEE 802.1X standard defines a port-based access control procedure that prevents unauthorized access to a network by requiring users to first submit credentials for authentication. One or more central servers, the backend servers, determine whether the user is allowed access to the network. These backend (RADIUS) servers are configured on the "**Security→802.1X Access Control→802.1X Setting**" page. The IEEE802.1X standard defines port-based operation, but non-standard variants overcome security limitations as shall be explored below.

The 802.1X Setting and Information screens in [Figure 4-9-3](#) & [Figure 4-9-4](#) appear.



Figure 4-9-3 802.1X Setting Page Screenshot

The page includes the following fields:

Object	Description
<ul style="list-style-type: none"> <li>802.1X</li> </ul>	Indicates if NAS is globally enabled or disabled on the switch. If globally disabled, all ports are allowed forwarding of frames.

#### Buttons

: Click to apply changes.

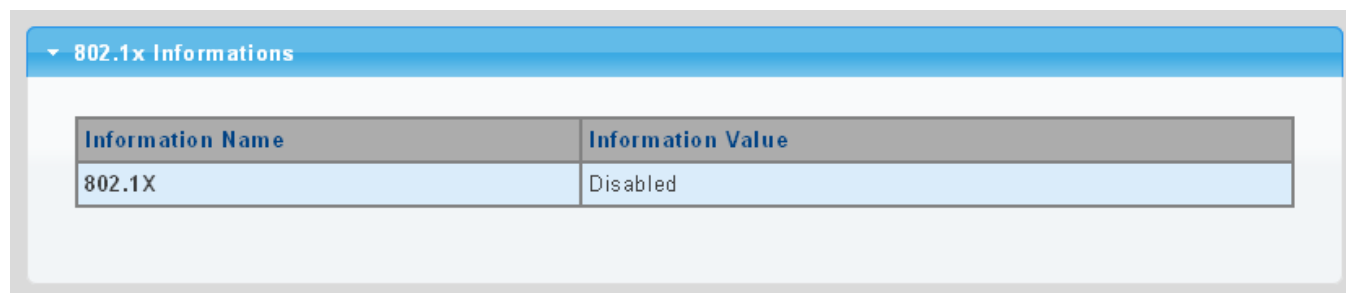

Figure 4-9-4 802.1X Information Page Screenshot

The page includes the following fields:

Object	Description
<ul style="list-style-type: none"> <li>802.1X</li> </ul>	Displays the current 802.1X state

### 4.9.1.3 802.1X Port Setting

This page allows you to configure the IEEE 802.1X Port Setting. The 802.1X Port Setting screens in [Figure 4-9-5](#) & [Figure 4-9-6](#) appear.

#### 802.1x Port Setting

<b>Port</b>	<input type="text" value="Select Ports"/>
<b>Mode</b>	<input type="text" value="No Authentication"/>
<b>Reauthentication Enable</b>	<input checked="" type="radio"/> Disable <input type="radio"/> Enable
<b>Reauthentication Period</b>	<input type="text" value="3600"/> (Range 30 - 65535, Default: 3600)
<b>Quiet Period</b>	<input type="text" value="60"/> (Range 0 - 65535, Default: 60)
<b>Supplicant Period</b>	<input type="text" value="30"/> (Range 1 - 65535, Default: 30)
<b>Maximum Request Retries</b>	<input type="text" value="2"/> (Range 1 - 10, Default: 2)

Figure 4-9-5 802.1X Port Setting Page Screenshot

The page includes the following fields:

Object	Description
• <b>Port</b>	Select port from this drop-down list
• <b>Mode</b>	<p>If NAS is globally enabled, this selection controls the port's authentication mode. The following modes are available:</p> <ul style="list-style-type: none"> <li>■ <b>No Authentication</b></li> <li>■ <b>Authentication</b></li> <li>■ <b>Force Authorized</b> <p>In this mode, the switch will send one EAPOL Success frame when the port link comes up, and any client on the port will be allowed network access without authentication.</p> </li> <li>■ <b>Force Unauthorized</b> <p>In this mode, the switch will send one EAPOL Failure frame when the port link comes up, and any client on the port will be disallowed network access.</p> </li> </ul>
• <b>Reauthentication Enable</b>	If checked, successfully authenticated supplicants/clients are reauthenticated after the interval specified by the Reauthentication Period. Reauthentication for 802.1X-enabled ports can be used to detect if a new device is plugged into a

	switch port or if a supplicant is no longer attached.
<ul style="list-style-type: none"> <li>• <b>Reauthentication Period</b></li> </ul>	<p>Determines the period, in seconds, after which a connected client must be reauthenticated. This is only active if the Reauthentication Enabled checkbox is checked.</p> <p>Valid values are in the range 30 to 65535 seconds.</p>
<ul style="list-style-type: none"> <li>• <b>Quiet Period</b></li> </ul>	Sets time to keep silent on supplicant authentication failure.
<ul style="list-style-type: none"> <li>• <b>Supplicant Period</b></li> </ul>	Sets the interval for the supplicant to re-transmit EAP request/identify frame.
<ul style="list-style-type: none"> <li>• <b>Maximum Request Retries</b></li> </ul>	<p>The number of times that the switch transmits an EAPOL Request Identity frame without response before considering entering the Guest VLAN is adjusted with this setting.</p> <p>The value can only be changed if the Guest VLAN option is globally enabled.</p>

**Buttons**



: Click to apply changes.

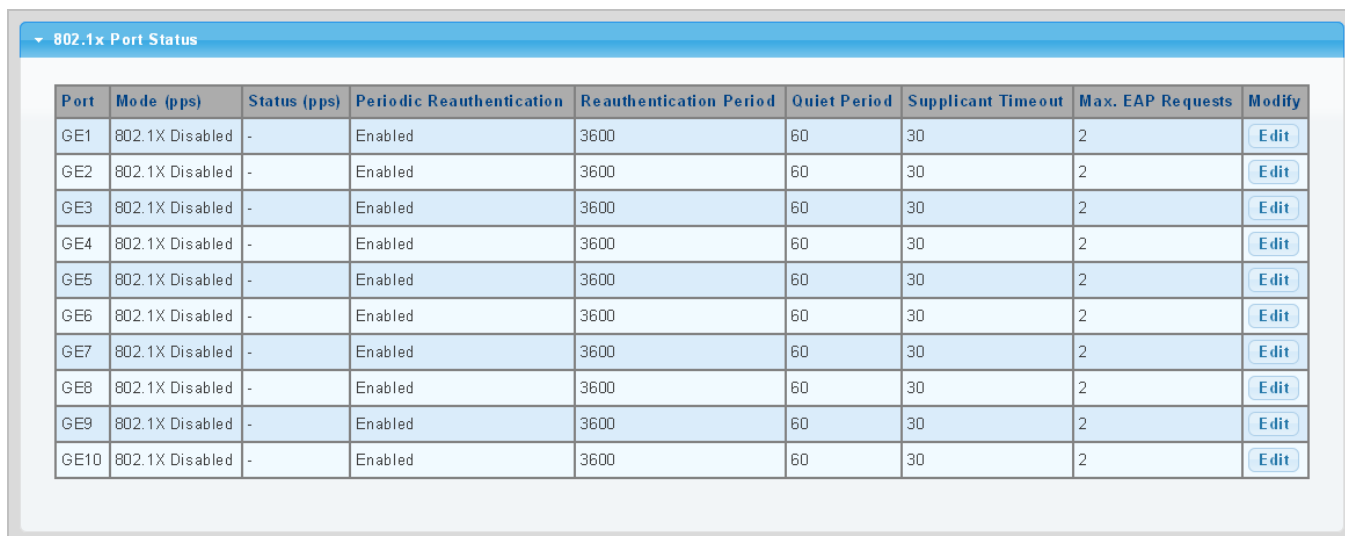

Port	Mode (pps)	Status (pps)	Periodic Reauthentication	Reauthentication Period	Quiet Period	Supplicant Timeout	Max. EAP Requests	Modify
GE1	802.1X Disabled	-	Enabled	3600	60	30	2	Edit
GE2	802.1X Disabled	-	Enabled	3600	60	30	2	Edit
GE3	802.1X Disabled	-	Enabled	3600	60	30	2	Edit
GE4	802.1X Disabled	-	Enabled	3600	60	30	2	Edit
GE5	802.1X Disabled	-	Enabled	3600	60	30	2	Edit
GE6	802.1X Disabled	-	Enabled	3600	60	30	2	Edit
GE7	802.1X Disabled	-	Enabled	3600	60	30	2	Edit
GE8	802.1X Disabled	-	Enabled	3600	60	30	2	Edit
GE9	802.1X Disabled	-	Enabled	3600	60	30	2	Edit
GE10	802.1X Disabled	-	Enabled	3600	60	30	2	Edit

**Figure 4-9-6** 802.1X Port Status Page Screenshot

The page includes the following fields:

Object	Description
<ul style="list-style-type: none"> <li>• <b>Port</b></li> </ul>	The switch port number of the logical port.
<ul style="list-style-type: none"> <li>• <b>Mode (pps)</b></li> </ul>	Displays the current mode.
<ul style="list-style-type: none"> <li>• <b>Status (pps)</b></li> </ul>	Displays the current status.
<ul style="list-style-type: none"> <li>• <b>Periodic Reauthentication</b></li> </ul>	Displays the current periodic reauthentication.



• <b>Reauthentication Period</b>	Displays the current reauthentication period.
• <b>Quiet Period</b>	Displays the current quiet period.
• <b>Supplicant Timeout</b>	Displays the current supplicant timeout.
• <b>Max. EAP Requests</b>	Displays the current Max. EAP requests.
• <b>Modify</b>	Click  to edit 802.1X port setting parameter.

#### 4.9.1.4 Guest VLAN Setting

##### Overview

When a Guest VLAN enabled port's link comes up, the switch starts transmitting EAPOL Request Identity frames. If the number of transmissions of such frames exceeds Max. Reauth. Count and no EAPOL frames have been received in the meantime, the switch considers entering the Guest VLAN. The interval between transmission of EAPOL Request Identity frames is configured with EAPOL Timeout. If Allow Guest VLAN if EAPOL Seen is enabled, the port will now be placed in the Guest VLAN. If disabled, the switch will first check its history to see if an EAPOL frame has previously been received on the port (this history is cleared if the port link goes down or the port's Admin State is changed), and if not, the port will be placed in the Guest VLAN. Otherwise it will not move to the Guest VLAN, but continue transmitting EAPOL Request Identity frames at the rate given by EAPOL Timeout.

Once in the Guest VLAN, the port is considered authenticated, and all attached clients on the port are allowed access on this VLAN. The switch will not transmit an EAPOL Success frame when entering the Guest VLAN.

While in the Guest VLAN, the switch monitors the link for EAPOL frames, and if one such frame is received, the switch immediately takes the port out of the Guest VLAN and starts authenticating the supplicant according to the port mode. If an EAPOL frame is received, the port will never be able to go back into the Guest VLAN if the "Allow Guest VLAN if EAPOL Seen" is disabled.

The 802.1X Guest VLAN setting screens in [Figure 4-9-7](#) & [Figure 4-9-8](#) appear.

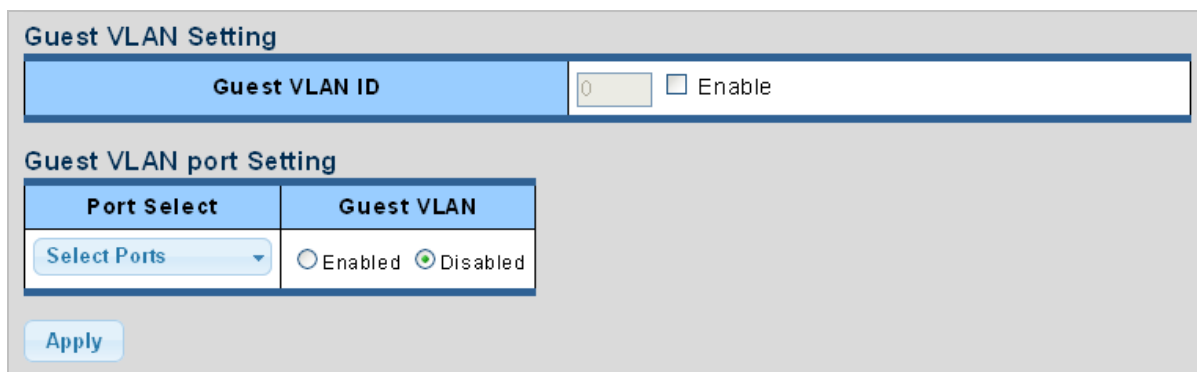

Figure 4-9-7 Guest VLAN Setting Page Screenshot

The page includes the following fields:

Object	Description
<ul style="list-style-type: none"> <li><b>Guest VLAN ID</b></li> </ul>	<p>This is the value that a port's Port VLAN ID is set to if a port is moved into the Guest VLAN. It is only changeable if the Guest VLAN option is globally enabled.</p> <p>Valid values are in the range [1~4094].</p>
<ul style="list-style-type: none"> <li><b>Guest VLAN Enabled</b></li> </ul>	<p>A Guest VLAN is a special VLAN - typically with limited network access - on which 802.1X-unaware clients are placed after a network administrator-defined timeout. The switch follows a set of rules for entering and leaving the Guest VLAN as listed below.</p> <p>The "Guest VLAN Enabled" checkbox provides a quick way to globally enable/disable Guest VLAN functionality.</p> <ul style="list-style-type: none"> <li>When checked, the individual ports' ditto setting determines whether the port can be moved into Guest VLAN.</li> <li>When unchecked, the ability to move to the Guest VLAN is disabled for all ports.</li> </ul>
<ul style="list-style-type: none"> <li><b>Guest VLAN Port Setting</b></li> </ul>	<p>When Guest VLAN is both globally enabled and enabled (checked) for a given port, the switch considers moving the port into the Guest VLAN according to the rules outlined below.</p> <p>This option is only available for EAPOL-based modes, i.e.:</p> <ul style="list-style-type: none"> <li><b>Port-based 802.1X</b></li> </ul>

**Buttons**

: Click to apply changes.

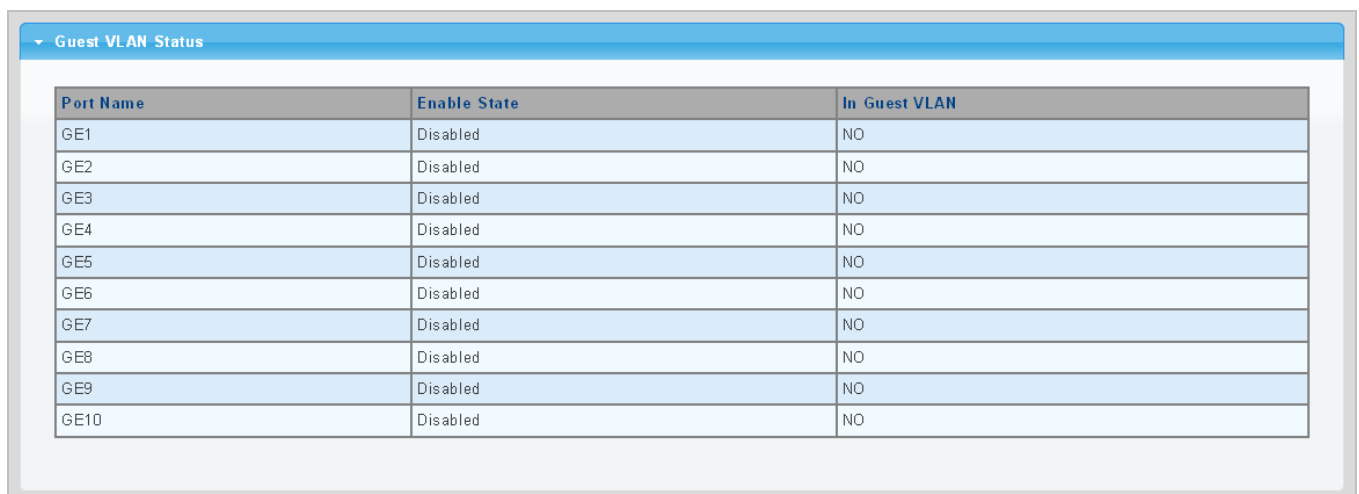

Port Name	Enable State	In Guest VLAN
GE1	Disabled	NO
GE2	Disabled	NO
GE3	Disabled	NO
GE4	Disabled	NO
GE5	Disabled	NO
GE6	Disabled	NO
GE7	Disabled	NO
GE8	Disabled	NO
GE9	Disabled	NO
GE10	Disabled	NO

Figure 4-9-8 Guest VLAN Status Page Screenshot

The page includes the following fields:

Object	Description
• <b>Port Name</b>	The switch port number of the logical port
• <b>Enable State</b>	Displays the current state
• <b>In Guest VLAN</b>	Displays the current guest VLAN

#### 4.9.1.5 Authenticated Host

The Authenticated Host Table screen in [Figure 4-9-9](#) appears.

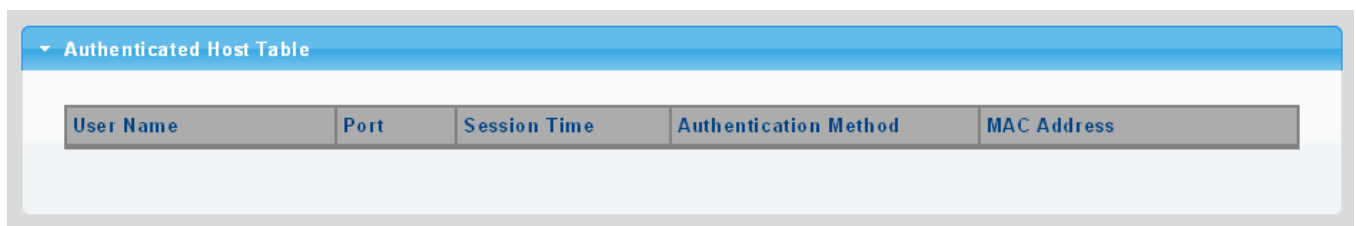

**Figure 4-9-9** Authenticated Host Table Page Screenshot

The page includes the following fields:

Object	Description
• <b>User Name</b>	Displays the current user name
• <b>Port</b>	Displays the current port number
• <b>Session Time</b>	Displays the current session time
• <b>Authentication Method</b>	Displays the current authentication method
• <b>MAC Address</b>	Displays the current MAC address

### 4.9.2 RADIUS Server

This page is to configure the RADIUS server connection session parameters. The RADIUS Settings screens in [Figure 4-9-10](#), [Figure 4-9-11](#) & [Figure 4-9-12](#) appears.

**Use Default Parameters**

<b>IP Version</b>	Version 6 Version 4
<b>Retries</b>	<input type="text" value="3"/> (Range 1 - 10, Default: 3)
<b>Timeout for Reply</b>	<input type="text" value="3"/> sec. (Range 1 - 30, Default: 3)
<b>Dead Time</b>	<input type="text" value="0"/> min. (Range 0 - 2000, Default: 0)
<b>Key String</b>	<input type="text"/> (0/63 ASCII Alphanumeric Characters Used)

**Figure 4-9-10** Use Default Parameters Page Screenshot

The page includes the following fields:

Object	Description
• <b>Retries</b>	Timeout is the number of seconds, in the range 1 to 10, to wait for a reply from a RADIUS server before retransmitting the request.
• <b>Timeout for Reply</b>	Retransmit is the number of times, in the range 1 to 30, a RADIUS request is retransmitted to a server that is not responding. If the server has not responded after the last retransmit it is considered to be dead.
• <b>Dead Time</b>	<p>The Dead Time, which can be set to a number between 0 and 3600 seconds, is the period during which the switch will not send new requests to a server that has failed to respond to a previous request. This will stop the switch from continually trying to contact a server that it has already determined as dead.</p> <p>Setting the Dead Time to a value greater than 0 (zero) will enable this feature, but only if more than one server has been configured.</p>
• <b>Key String</b>	The secret key - up to 63 characters long - shared between the RADIUS server and the switch.

**Buttons**

: Click to apply changes.

### New Radius Server

<b>Server Definition</b>	<input checked="" type="radio"/> By IP address <input type="radio"/> By name	
<b>Server IP</b>	<input type="text"/>	
<b>Authentication Port</b>	<input type="text" value="1812"/>	(0 - 65535)
<b>Acct Port</b>	<input type="text" value="1813"/>	(0 - 65535)
<b>Key String</b>	<input checked="" type="checkbox"/> Use Default	<input type="text"/>
<b>Timeout for Reply</b>	<input checked="" type="checkbox"/> Use Default	<input type="text"/> (1-30) secs
<b>Retries</b>	<input checked="" type="checkbox"/> Use Default	<input type="text"/> (1 - 10)
<b>Server Priority</b>	<input type="text" value="1"/>	(0 - 65535)
<b>Dead Time</b>	<input type="text" value="0"/>	(0 - 2000)
<b>Usage Type</b>	<input type="radio"/> Login <input type="radio"/> 802.1X <input checked="" type="radio"/> All	

Figure 4-9-11 New Radius Server Page Screenshot

The page includes the following fields:

Object	Description
• <b>Server Definition</b>	Set the server definition
• <b>Server IP</b>	Address of the Radius server IP/name
• <b>Authentication Port</b>	The UDP port to use on the RADIUS Authentication Server. If the port is set to 0 (zero), the default port (1812) is used on the RADIUS Authentication Server.
• <b>Acct Port</b>	The UDP port to use on the RADIUS Accounting Server. If the port is set to 0 (zero), the default port (1813) is used on the RADIUS Accounting Server.
• <b>Key String</b>	The shared key - shared between the RADIUS Authentication Server and the switch.
• <b>Timeout for Reply</b>	<p>The Timeout, which can be set to a number between 1 and 30 seconds, is the maximum time to wait for a reply from a server.</p> <p>If the server does not reply within this timeframe, we will consider it to be dead and continue with the next enabled server (if any).</p> <p>RADIUS servers are using the UDP protocol, which is unreliable by design. In order to cope with lost frames, the timeout interval is divided into 3 subintervals of equal length. If a reply is not received within the subinterval, the request is transmitted again. This algorithm causes the RADIUS server to be queried up to 3 times before it is considered to be dead.</p>
• <b>Retries</b>	Timeout is the number of seconds, in the range 1 to 10, to wait for a reply from a RADIUS server before retransmitting the request.

• <b>Server Priority</b>	Set the server priority
• <b>Dead Time</b>	The Dead Time, which can be set to a number between 0 and 3600 seconds, is the period during which the switch will not send new requests to a server that has failed to respond to a previous request. This will stop the switch from continually trying to contact a server that it has already determined as dead.  Setting the Dead Time to a value greater than 0 (zero) will enable this feature, but only if more than one server has been configured.
• <b>Usage Type</b>	Set the usage type. The following modes are available: <ul style="list-style-type: none"> <li>■ <b>Login</b></li> <li>■ <b>802.1X</b></li> <li>■ <b>All</b></li> </ul>



**Buttons**

 : Click to add Radius server setting.



**Figure 4-9-12** Login Authentication List Page Screenshot

The page includes the following fields:

Object	Description
• <b>IP Address</b>	Displays the current IP address
• <b>Auth Port</b>	Displays the current auth port
• <b>Acct Port</b>	Displays the current acct port
• <b>Key</b>	Displays the current key
• <b>Timeout</b>	Displays the current timeout
• <b>Retries</b>	Displays the current retry times
• <b>Priority</b>	Displays the current priority
• <b>Dead Time</b>	Displays the current dead time
• <b>Usage Type</b>	Displays the current usage type
• <b>Modify</b>	Click  to edit login authentication list parameter.  Click  to delete login authentication list entry.

### 4.9.3 TACACS+ Server

This page is to configure the RADIUS server connection session parameters. The RADIUS Settings screens in [Figure 4-9-13](#), [Figure 4-9-14](#) & [Figure 4-9-15](#) appear.

**Use Default Parameters**

<b>IP Version</b>	Version 6 Version 4
<b>Key String</b>	<input type="text"/> (0/63 ASCII Alphanumeric Characters Used)
<b>Timeout for Reply</b>	<input type="text" value="5"/> sec. (Range 1 - 30, Default: 5)

Figure 4-9-13 Guest VLAN Setting Page Screenshot

The page includes the following fields:

Object	Description
<ul style="list-style-type: none"> <li>• <b>Key String</b></li> </ul>	The secret key - up to 63 characters long - shared between the TACACS+ server and the switch.
<ul style="list-style-type: none"> <li>• <b>Timeout for Reply</b></li> </ul>	Retransmit is the number of times, in the range 1 to 30, a TACACS+ request is retransmitted to a server that is not responding. If the server has not responded after the last retransmit it is considered to be dead.

**Buttons**

: Click to apply changes.

**New Tacacs+ Server**

<b>Server Definition</b>	<input checked="" type="radio"/> By IP address <input type="radio"/> By name
<b>Server IP</b>	<input type="text"/>
<b>Server Port</b>	<input type="text" value="49"/> (0 - 65535)
<b>Server Key</b>	<input checked="" type="checkbox"/> Use Default <input type="text"/>
<b>Server Timeout</b>	<input checked="" type="checkbox"/> Use Default <input type="text"/> (1-30) secs
<b>Server Priority</b>	<input type="text" value="1"/> (0 - 65535)

Figure 4-9-14 New Radius Server Page Screenshot

The page includes the following fields:

Object	Description
• <b>Server Definition</b>	Set the server definition
• <b>Server IP</b>	Address of the TACACS+ server IP/name
• <b>Server Port</b>	Network (TCP) port of TACACS+ server used for authentication messages. (Range: 1-65535; Default: <b>49</b> )
• <b>Server Key</b>	The key- shared between the TACACS+ Authentication Server and the switch.
• <b>Server Timeout</b>	The number of seconds the switch waits for a reply from the server before it resends the request.
• <b>Server Priority</b>	Set the server priority

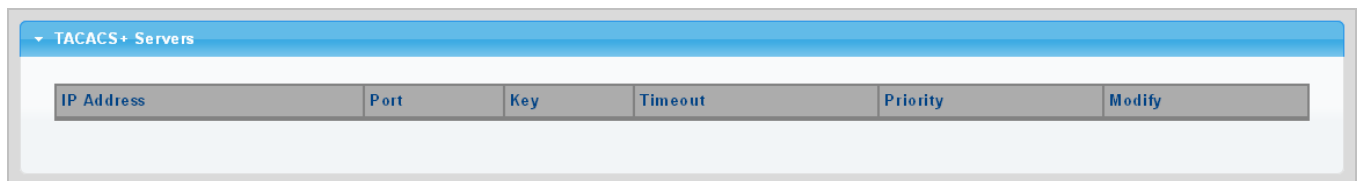

**Buttons**

 : Click to add Radius server setting.



**Figure 4-9-15** Login Authentication List Page Screenshot

The page includes the following fields:

Object	Description
• <b>IP Address</b>	Displays the current IP address
• <b>Port</b>	Displays the current port
• <b>Key</b>	Displays the current key
• <b>Timeout</b>	Displays the current timeout
• <b>Retries</b>	Displays the current retry times
• <b>Priority</b>	Displays the current priority
• <b>Modify</b>	Click  to edit login authentication list parameter  Click  to delete login authentication list entry



#### 4.9.4 AAA

**Authentication, authorization, and accounting (AAA)** provides a framework for configuring access control on the Industrial Managed Switch. The three security functions can be summarized as follows:

- **Authentication** — Identifies users that request access to the network.
- **Authorization** — Determines if users can access specific services.
- **Accounting** — Provides reports, auditing, and billing for services that users have accessed on the network.

The AAA functions require the use of configured RADIUS or TACACS+ servers in the network. The security servers can be defined as sequential groups that are then applied as a method for controlling user access to specified services. For example, when the switch attempts to authenticate a user, a request is sent to the first server in the defined group, if there is no response the second server will be tried, and so on. If at any point a pass or fail is returned, the process stops.

The Industrial Managed Switch supports the following AAA features:

- Accounting for **IEEE 802.1X authenticated users** that access the network through the Industrial Managed Switch.
- Accounting for users that access **management interfaces** on the Industrial Managed Switch through the console and Telnet.
- Accounting for **commands** that users enter at specific CLI privilege levels. Authorization of users that access management interfaces on the Industrial Managed Switch through the console and Telnet.

To configure AAA on the Industrial Managed Switch, you need to follow this general process:

1. Configure RADIUS and TACACS+ server access parameters. See "[Configuring Local/Remote Logon Authentication](#)".
2. Define RADIUS and TACACS+ server groups to support the accounting and authorization of services.
3. Define a method name for each service to which you want to apply accounting or authorization and specify the RADIUS or TACACS+ server groups to use. Apply the method names to port or line interfaces.



---

This guide assumes that RADIUS and TACACS+ servers have already been configured to support AAA. The configuration of RADIUS and TACACS+ server software is beyond the scope of this guide, refer to the documentation provided with the RADIUS or TACACS+ server software.

---

### 4.9.4.1 Login List

This page is to login list parameters. The authentication list screen in [Figure 4-9-17](#) & [Figure 4-9-18](#) appears.

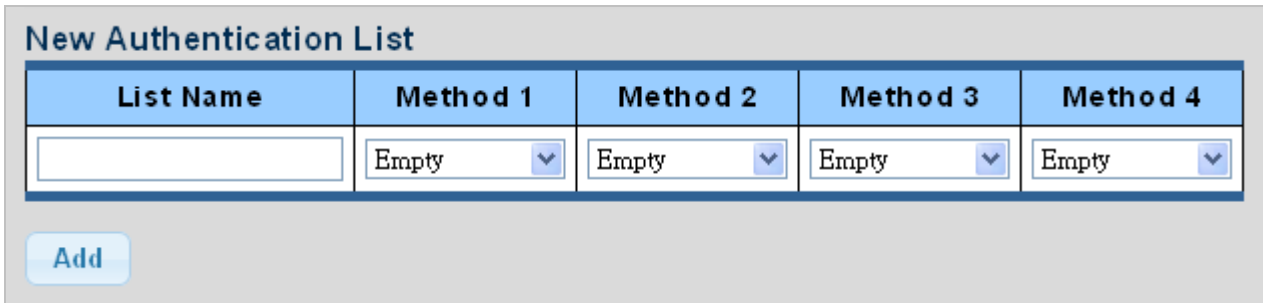

The screenshot shows a form titled "New Authentication List". It contains a table with five columns: "List Name", "Method 1", "Method 2", "Method 3", and "Method 4". The "List Name" column has an empty text input field. Each of the "Method" columns has a dropdown menu currently set to "Empty". Below the table is a blue "Add" button.

Figure 4-9-17 New Authentication List Screenshot

The page includes the following fields:

Object	Description
<ul style="list-style-type: none"> <li>List Name</li> </ul>	Defines a name for the authentication list
<ul style="list-style-type: none"> <li>Method 1-4</li> </ul>	Set the login authentication method: Empty / None / Local / TACACS+ / RADIUS / Enable

#### Buttons

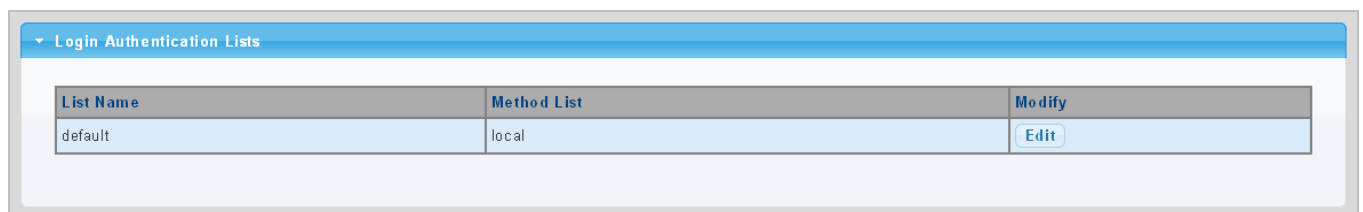

: Click to add authentication list.



The screenshot shows a table titled "Login Authentication Lists". The table has three columns: "List Name", "Method List", and "Modify". There is one row with "default" in the "List Name" column and "local" in the "Method List" column. In the "Modify" column, there is an "Edit" button.

Figure 4-9-18 Login Authentication List Screenshot

The page includes the following fields:

Object	Description
<ul style="list-style-type: none"> <li>List Name</li> </ul>	Displays the current list name
<ul style="list-style-type: none"> <li>Method List</li> </ul>	Displays the current method list
<ul style="list-style-type: none"> <li>Modify</li> </ul>	Click  to edit login authentication list parameter  Click  to delete login authentication list entry

### 4.9.4.2 Enable List

This page is to login list parameters. The authentication list screens in [Figure 4-9-19](#) & [Figure 4-9-20](#) appear.

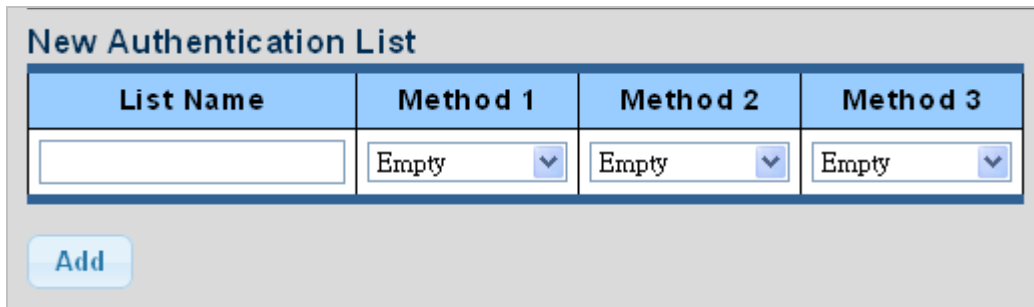

List Name	Method 1	Method 2	Method 3
<input type="text"/>	Empty <input type="button" value="v"/>	Empty <input type="button" value="v"/>	Empty <input type="button" value="v"/>

**Figure 4-9-19** New Authentication List Screenshot

The page includes the following fields:

Object	Description
<ul style="list-style-type: none"> <li>• <b>List Name</b></li> </ul>	Defines a name for the authentication list
<ul style="list-style-type: none"> <li>• <b>Method 1-3</b></li> </ul>	Set the login authentication method: Empty / None / Enable / TACACS+ / RADIUS

#### Buttons

: Click to add authentication list.

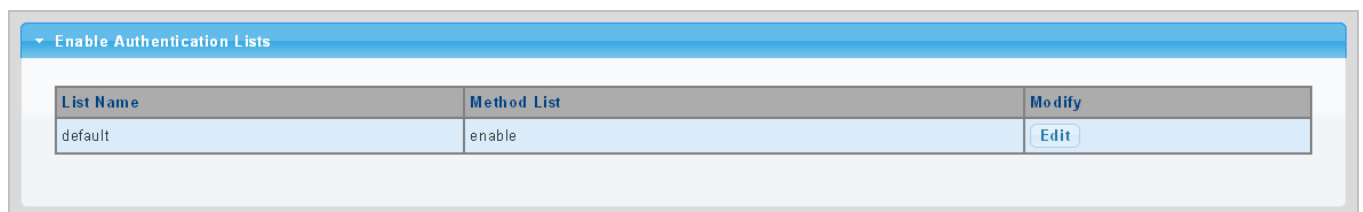

List Name	Method List	Modify
default	enable	<input type="button" value="Edit"/>

**Figure 4-9-20** Login Authentication List Screenshot

The page includes the following fields:

Object	Description
<ul style="list-style-type: none"> <li>• <b>List Name</b></li> </ul>	Displays the current list name
<ul style="list-style-type: none"> <li>• <b>Method List</b></li> </ul>	Displays the current method list
<ul style="list-style-type: none"> <li>• <b>Modify</b></li> </ul>	Click <input type="button" value="Edit"/> to edit login authentication list parameter  Click <input type="button" value="Delete"/> to delete login authentication list entry

## 4.9.5 Access

This section is to control the access of the Industrial Managed Switch, including the different access methods – Telnet, SSH, HTTP and HTTPS.

### 4.9.5.1 Telnet

The Telnet Settings and Information screen in [Figure 4-9-21](#) & [Figure 4-9-22](#) appear.

**Telnet Settings**

<b>Telnet Service</b>	Disabled <input type="button" value="v"/>
<b>Login Authentication List</b>	default <input type="button" value="v"/>
<b>Enable Authentication List</b>	default <input type="button" value="v"/>
<b>Session Timeout</b>	<input type="text" value="10"/> (0-65535) minutes
<b>Password Retry Count</b>	<input type="text" value="3"/> (0-120)
<b>Silent Time</b>	<input type="text" value="0"/> (0-65535) seconds

**Figure 4-9-21** Telnet Settings Page Screenshot

The page includes the following fields:

Object	Description
• <b>Telnet Service</b>	Disables or enable telnet service
• <b>Login Authentication List</b>	Select login authentication list for this drop down list
• <b>Enable Authentication List</b>	Select enable authentication list for this drop down list
• <b>Session Timeout</b>	Set the session timeout value
• <b>Password Retry Count</b>	Set the password retry count value
• <b>Silent Time</b>	Set the silent time value

#### Buttons

: Click to apply changes

: Click to disconnect telnet communication

Telnet Information	
Information Name	Information Value
Telnet Service	Disabled
Login Authentication List	default
Enable Authentication List	default
Session Timeout	10
Password Retry Count	3
Silent Time	0
Current Telnet Sessions Count	0

Figure 4-9-21 Telnet Information Page Screenshot

The page includes the following fields:

Object	Description
• <b>Telnet Service</b>	Displays the current Telnet service
• <b>Login Authentication List</b>	Displays the current login authentication list
• <b>Enable Authentication List</b>	Displays the current enable authentication list
• <b>Session Timeout</b>	Displays the current session timeout
• <b>Password Retry Count</b>	Displays the current password retry count
• <b>Silent Time</b>	Displays the current silent time
• <b>Current Telnet Session Count</b>	Displays the current telnet session count

#### 4.9.5.2 SSH

Configure SSH on this page. This page shows the Port Security status. Port Security is a module with no direct configuration. Configuration comes indirectly from other modules - the user modules. When a user module has enabled port security on a port, the port is set-up for software-based learning. In this mode, frames from unknown MAC addresses are passed on to the port security module, which in turn asks all user modules whether to allow this new MAC address to forward or block it. For a MAC address to be set in the forwarding state, all enabled user modules must unanimously agree on allowing the MAC address to forward. If only one chooses to block it, it will be blocked until that user module decides otherwise.

The SSH Settings and Information screens in [Figure 4-9-23](#) & [Figure 4-9-24](#) appear.

**SSH Settings**

<b>SSH Service</b>	Disabled <input type="button" value="v"/>
<b>Login Authentication List</b>	default <input type="button" value="v"/>
<b>Enable Authentication List</b>	default <input type="button" value="v"/>
<b>Session Timeout</b>	<input type="text" value="10"/> (0-65535) minutes
<b>Password Retry Count</b>	<input type="text" value="3"/> (0-120) minutes
<b>Silent Time</b>	<input type="text" value="0"/> (0-65535) seconds

Figure 4-9-23 SSH Settings Page Screenshot

The page includes the following fields:

Object	Description
• <b>SSH Service</b>	Disable or enable SSH service
• <b>Login Authentication List</b>	Select login authentication list for this drop down list
• <b>Enable Authentication List</b>	Select enable authentication list for this drop down list
• <b>Session Timeout</b>	Set the session timeout value
• <b>Password Retry Count</b>	Set the password retry count value
• <b>Silent Time</b>	Set the silent time value

**Buttons**

: Click to apply changes.

: Click to disconnect telnet communication.

SSH Information

Information Name	Information Value
SSH Service	Disabled
Login Authentication List	default
Enable Authentication List	default
Session Timeout	10
Password Retry Count	3
Silent Time	0
Current SSH Sessions Count	0

Figure 4-9-24 SSH Information Page Screenshot

The page includes the following fields:

Object	Description
• SSH Service	Displays the current SSH service
• Login Authentication List	Displays the current login authentication list
• Enable Authentication List	Displays the current enable authentication list
• Session Timeout	Displays the current session timeout
• Password Retry Count	Displays the current password retry count
• Silent Time	Displays the current silent time
• Current SSH Session Count	Displays the current SSH session count

### 4.9.5.3 HTTP

The HTTP Settings and Information screens in [Figure 4-9-25](#) & [Figure 4-9-26](#) appear.

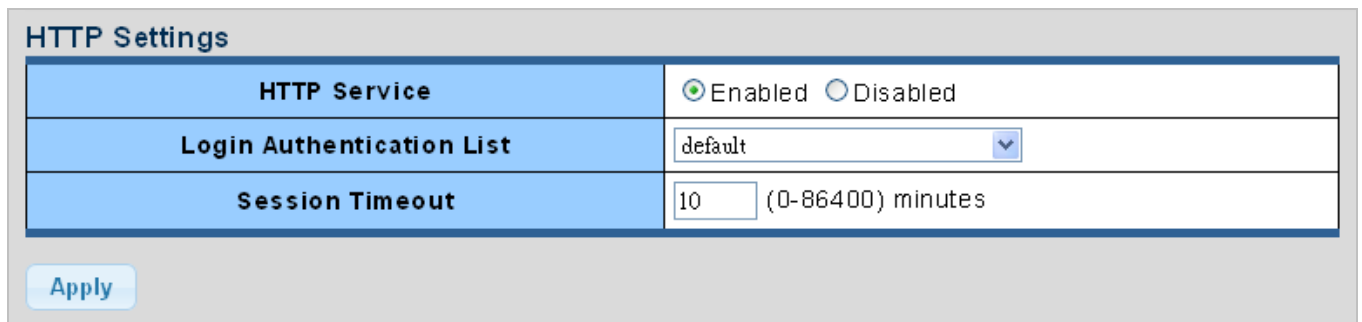

Figure 4-9-25 HTTP Settings Page Screenshot

The page includes the following fields:

Object	Description
• HTTP Service	Disable or enable HTTP service
• Login Authentication List	Select login authentication list for this drop down list
• Session Timeout	Set the session timeout value

#### Buttons

: Click to apply changes.

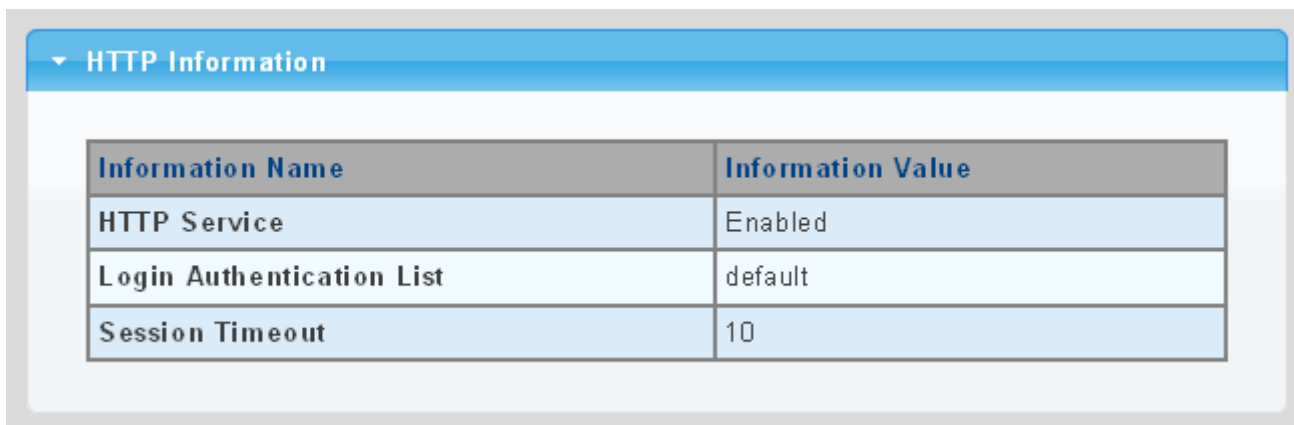

Figure 4-9-26 HTTP Information Page Screenshot

The page includes the following fields:

Object	Description
• HTTP Service	Displays the current HTTP service
• Login Authentication List	Displays the current login authentication list
• Session Timeout	Displays the current session timeout

#### 4.9.5.4 HTTPS

The HTTPS Settings and Information screen in [Figure 4-9-27](#) & [Figure 4-9-28](#) appear.

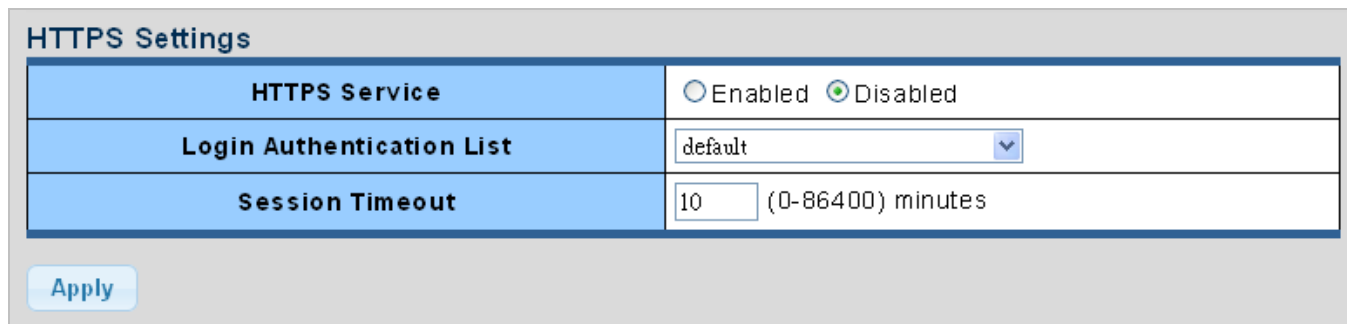

Figure 4-9-27 HTTPS Settings Page Screenshot

The page includes the following fields:

Object	Description
• HTTPS Service	Disable or enable HTTPS service
• Login Authentication List	Select login authentication list for this drop down list
• Session Timeout	Set the session timeout value

#### Buttons

: Click to apply changes.



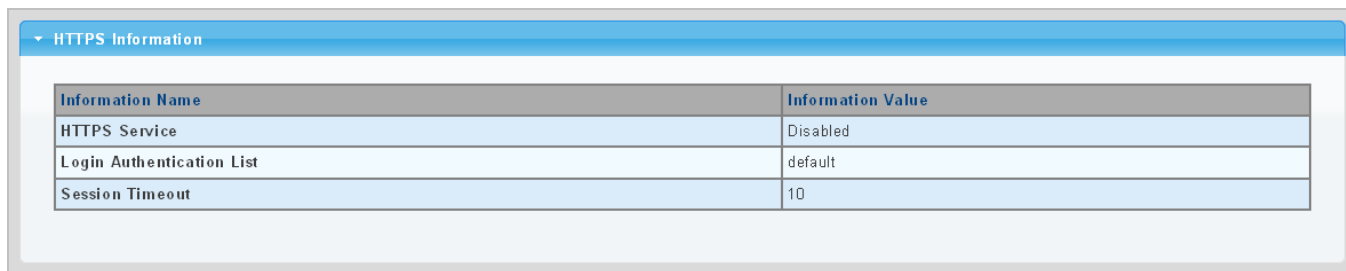

Figure 4-9-28 HTTPS Information Page Screenshot

The page includes the following fields:

Object	Description
<ul style="list-style-type: none"> <li>• <b>HTTPS Service</b></li> </ul>	Displays the current HTTPS service
<ul style="list-style-type: none"> <li>• <b>Login Authentication List</b></li> </ul>	Displays the current login authentication list
<ul style="list-style-type: none"> <li>• <b>Session Timeout</b></li> </ul>	Displays the current session timeout

## 4.9.6 Management Access Method

### 4.9.6.1 Profile Rules

The Profile Rule Table Setting and Table screens in [Figure 4-9-29](#) & [Figure 4-9-30](#) appear.

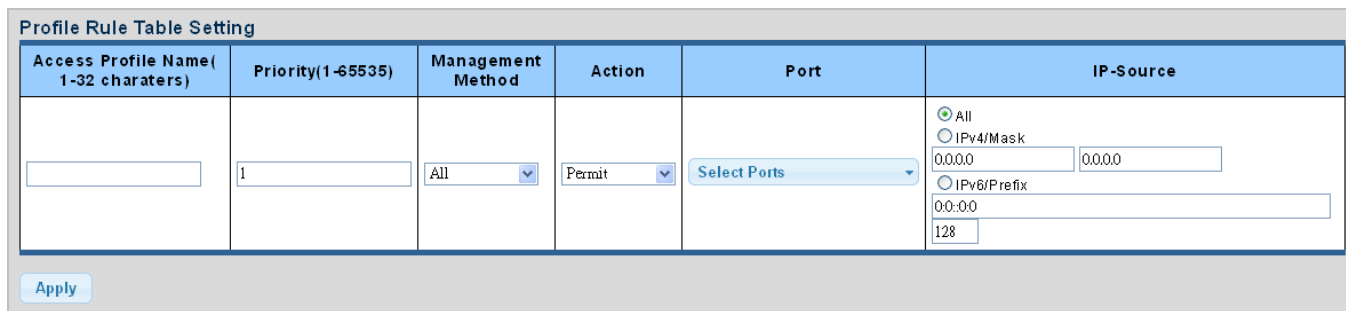



Figure 4-9-29 Profile Rule Table Setting Page Screenshot

The page includes the following fields:

Object	Description
<ul style="list-style-type: none"> <li>• <b>Access Profile Name (1-32 characters)</b></li> </ul>	Indicates the access profile name
<ul style="list-style-type: none"> <li>• <b>Priority (1-65535)</b></li> </ul>	Set priority The allowed value is from 1 to 65535
<ul style="list-style-type: none"> <li>• <b>Management Method</b></li> </ul>	Indicates the host can access the switch from

	HTTP/HTTPS/telnet/SSH/SNMP/All interface that the host IP address matched the entry.
• <b>Action</b>	An IP address can contain any combination of permit or deny rules. (Default: <b>Permit</b> rules)Sets the access mode of the profile; either <b>permit</b> or <b>deny</b> .
• <b>Port</b>	Select port for this drop down list
• <b>IP-Source</b>	Indicates the IP address for the access management entry

**Buttons**

: Click to apply changes.

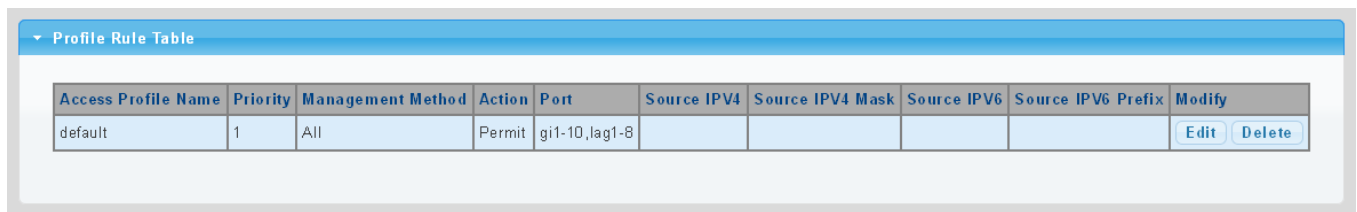

**Figure 4-9-30** Profile Rule Table Page Screenshot

The page includes the following fields:

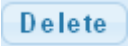
Object	Description
• <b>Access Profile Name</b>	Displays the current access profile name
• <b>Priority</b>	Displays the current priority
• <b>Management Method</b>	Displays the current management method
• <b>Action</b>	Displays the current action
• <b>Port</b>	Displays the current port list
• <b>Source IPv4</b>	Displays the current source IPv4 address
• <b>Source IPv4 Mask</b>	Displays the current source IPv4 mask
• <b>Source IPv6</b>	Displays the current source IPv6 address
• <b>Source IPv6 Prefix</b>	Displays the current source IPv6 prefix
• <b>Modify</b>	Click  to edit profile rule parameter  Click  to delete profile rule entry

### 4.9.6.2 Access Rules

The access profile screens in [Figure 4-9-31](#) & [Figure 4-9-32](#) appear.

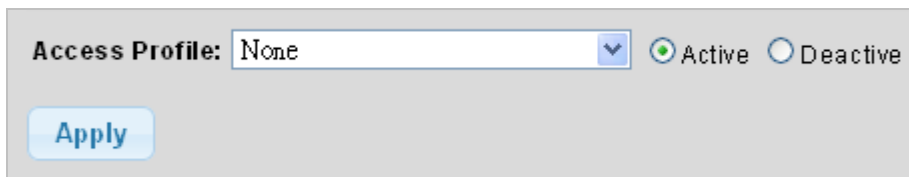

**Figure 4-9-31** Access Profile Page Screenshot

The page includes the following fields:

Object	Description
<ul style="list-style-type: none"> <li>• Access Profile</li> </ul>	Select access profile for this drop down list

#### Buttons

: Click to apply changes.

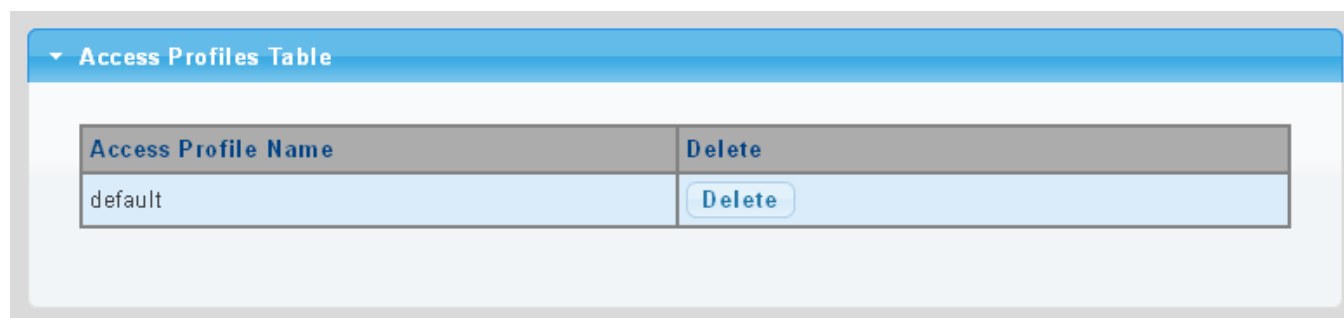

**Figure 4-9-32** Access Profile Table Page Screenshot

The page includes the following fields:

Object	Description
<ul style="list-style-type: none"> <li>• Access Profile</li> </ul>	Displays the current access profile
<ul style="list-style-type: none"> <li>• Delete</li> </ul>	Click  to delete access profile entry

## 4.9.7 DHCP Snooping

### 4.9.7.1 DHCP Snooping Overview

The addresses assigned to DHCP clients on unsecure ports can be carefully controlled using the dynamic bindings registered with DHCP Snooping. DHCP snooping allows a switch to protect a network from rogue DHCP servers or other devices which send port-related information to a DHCP server. This information can be useful in tracking an IP address back to a physical port.

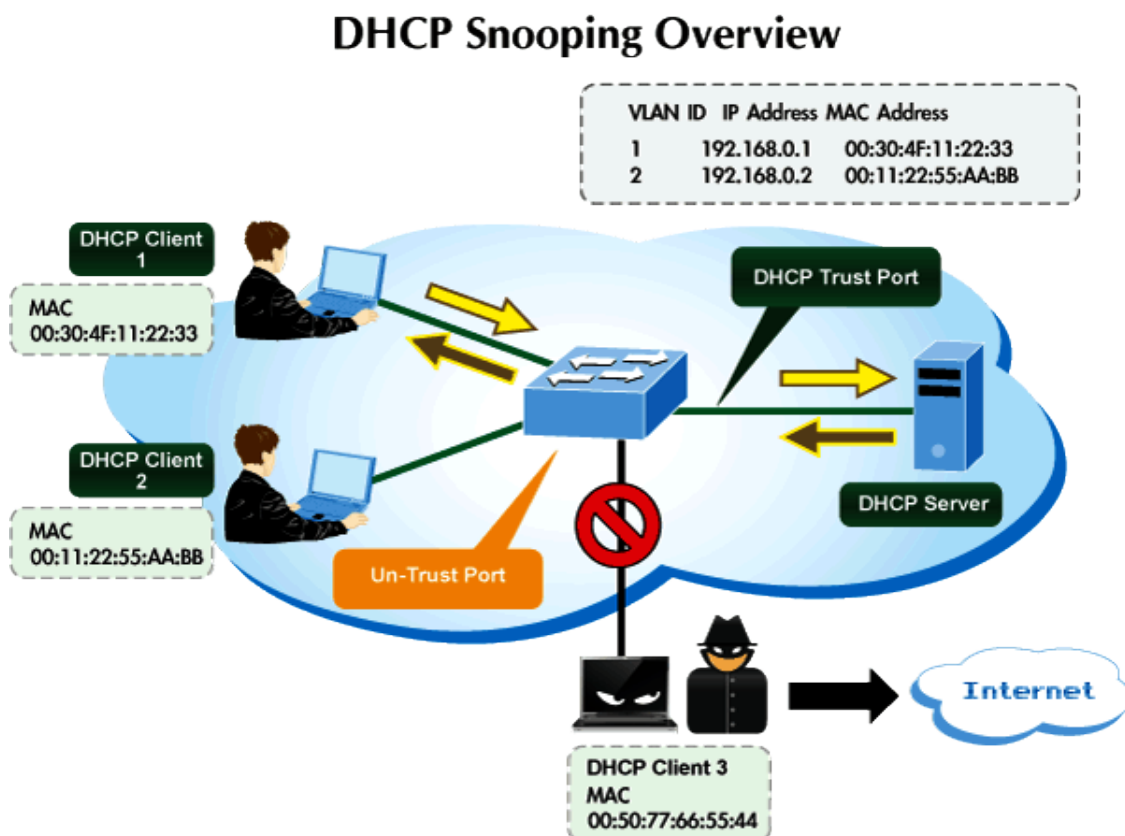

#### Command Usage

- Network traffic may be disrupted when malicious DHCP messages are received from an outside source. **DHCP snooping is used to filter DHCP messages received on a non-secure interface from outside the network or firewall.** When DHCP snooping is enabled globally and enabled on a VLAN interface, **DHCP messages received on an untrusted interface from a device not listed in the DHCP snooping table will be dropped.**
- Table entries are only learned for trusted interfaces. An entry is added or removed dynamically to the DHCP snooping table when a client receives or releases an IP address from a DHCP server. Each entry includes a MAC address, IP address, lease time, VLAN identifier, and port identifier.
- When DHCP snooping is enabled, DHCP messages entering an untrusted interface are filtered based upon dynamic entries learned via DHCP snooping.
- Filtering rules are implemented as follows:
  - If the global DHCP snooping is disabled, all DHCP packets are forwarded.

- If DHCP snooping is enabled globally, and also enabled on the VLAN where the DHCP packet is received, all DHCP packets are forwarded for a trusted port. If the received packet is a DHCP ACK message, a dynamic DHCP snooping entry is also added to the binding table.
- If DHCP snooping is enabled globally, and also enabled on the VLAN where the DHCP packet is received, but the port is not trusted, it is processed as follows:
  - If the DHCP packet is a reply packet from a DHCP server (including OFFER, ACK or NAK messages), the packet is dropped.
  - If the DHCP packet is from a client, such as a DECLINE or RELEASE message, the switch forwards the packet only if the corresponding entry is found in the binding table.
  - If the DHCP packet is from a client, such as a DISCOVER, REQUEST, INFORM, DECLINE or RELEASE message, the packet is forwarded if MAC address verification is disabled. However, if MAC address verification is enabled, then the packet will only be forwarded if the client's hardware address stored in the DHCP packet is the same as the source MAC address in the Ethernet header.
  - If the DHCP packet is not a recognizable type, it is dropped.
- If a DHCP packet from a client passes the filtering criteria above, it will only be forwarded to trusted ports in the same VLAN.
- If a DHCP packet is from server is received on a trusted port, it will be forwarded to both trusted and untrusted ports in the same VLAN.
- If the DHCP snooping is globally disabled, all dynamic bindings are removed from the binding table.
  - Additional considerations when the switch itself is a DHCP client – The port(s) through which the switch submits a client request to the DHCP server must be configured as trusted. Note that the switch will not add a dynamic entry for itself to the binding table when it receives an ACK message from a DHCP server. Also, when the switch sends out DHCP client packets for itself, no filtering takes place. However, when the switch receives any messages from a DHCP server, any packets received from untrusted ports are dropped.

### 4.9.7.2 Global Setting

DHCP Snooping is used to block intruder on the untrusted ports of switch when it tries to intervene by injecting a bogus DHCP reply packet to a legitimate conversation between the DHCP client and server. Configure DHCP Snooping on this page. The DHCP Snooping Setting and Information screens in [Figure 4-9-33](#) & [Figure 4-9-34](#) appear.

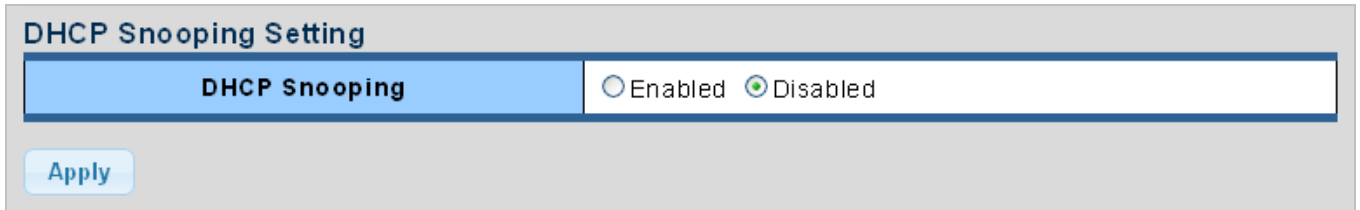



Figure 4-9-33 DHCP Snooping Setting Page Screenshot

The page includes the following fields:

Object	Description
<ul style="list-style-type: none"> <li>DHCP Snooping</li> </ul>	<p>Indicates the DHCP snooping mode operation. Possible modes are:</p> <ul style="list-style-type: none"> <li><b>Enabled:</b> Enable DHCP snooping mode operation. When enable DHCP snooping mode operation, the request DHCP messages will be forwarded to trusted ports and only allowed reply packets from trusted ports.</li> <li><b>Disabled:</b> Disable DHCP snooping mode operation.</li> </ul>

#### Buttons

: Click to apply changes.

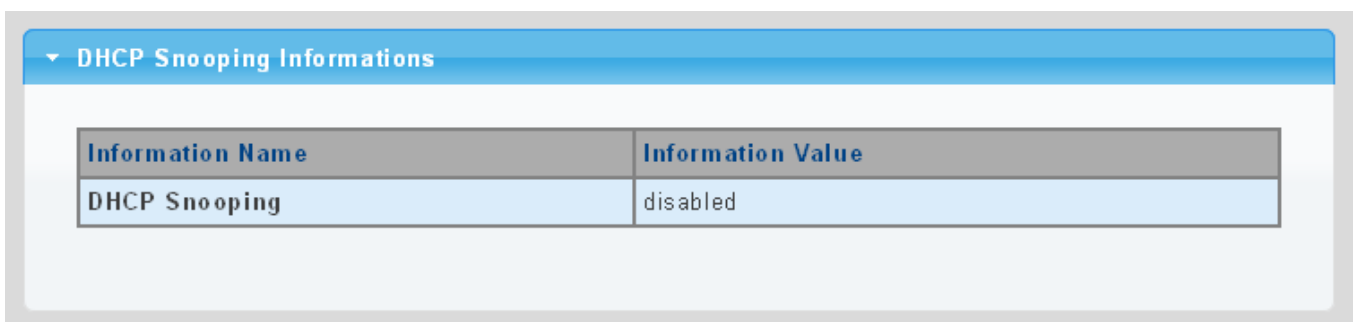

Figure 4-9-34 DHCP Snooping Information Page Screenshot

The page includes the following fields:

Object	Description
<ul style="list-style-type: none"> <li>DHCP Snooping</li> </ul>	Displays the current DHCP snooping status

### 4.9.7.3 DHCP Snooping VLAN Setting

#### Command Usage

- When DHCP snooping is enabled globally on the switch, and enabled on the specified VLAN, DHCP packet filtering will be performed on any untrusted ports within the VLAN.
- When the DHCP snooping is globally disabled, DHCP snooping can still be configured for specific VLANs, but the changes will not take effect until DHCP snooping is globally re-enabled.
- When DHCP snooping is globally enabled, and DHCP snooping is then disabled on a VLAN, all dynamic bindings learned for this VLAN are removed from the binding table.

The DHCP Snooping VLAN Setting screens in [Figure 4-9-35](#) & [Figure 4-9-36](#) appear.

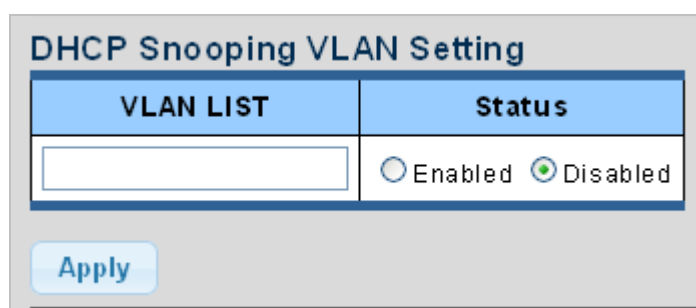

Figure 4-9-35 DHCP Snooping VLAN Setting Page Screenshot

The page includes the following fields:

Object	Description
<ul style="list-style-type: none"> <li>• <b>VLAN List</b></li> </ul>	Indicates the ID of this particular VLAN.
<ul style="list-style-type: none"> <li>• <b>Status</b></li> </ul>	<p>Indicates the DHCP snooping mode operation. Possible modes are:</p> <ul style="list-style-type: none"> <li>■ <b>Enabled:</b> Enable DHCP snooping mode operation. When enable DHCP snooping mode operation, the request DHCP messages will be forwarded to trusted ports and only allowed reply packets from trusted ports.</li> <li>■ <b>Disabled:</b> Disable DHCP snooping mode operation.</li> </ul>

#### Buttons

: Click to apply changes.

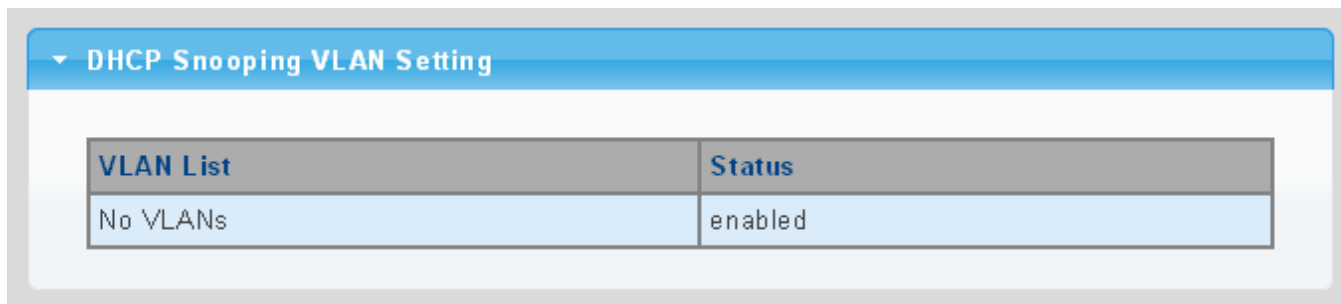

Figure 4-9-36 DHCP Snooping VLAN Setting Page Screenshot

The page includes the following fields:

Object	Description
<ul style="list-style-type: none"> <li>VLAN List</li> </ul>	Displays the current VLAN list
<ul style="list-style-type: none"> <li>Status</li> </ul>	Displays the current DHCP snooping status

#### 4.9.7.4 Port Setting

Configures switch ports as trusted or untrusted.

##### Command Usage

- A trusted interface is an interface that is configured to receive only messages from within the network. An untrusted interface is an interface that is configured to receive messages from outside the network or firewall.
- When DHCP snooping enabled both globally and on a VLAN, DHCP packet filtering will be performed on any untrusted ports within the VLAN.
- When an untrusted port is changed to a trusted port, all the dynamic DHCP snooping bindings associated with this port are removed.
- Set all ports connected to DHCP servers within the local network or firewall to trusted state. Set all other ports outside the local network or firewall to untrusted state.

The DHCP Snooping Port Setting screen in [Figure 4-9-37](#) & [Figure 4-9-38](#) appears.

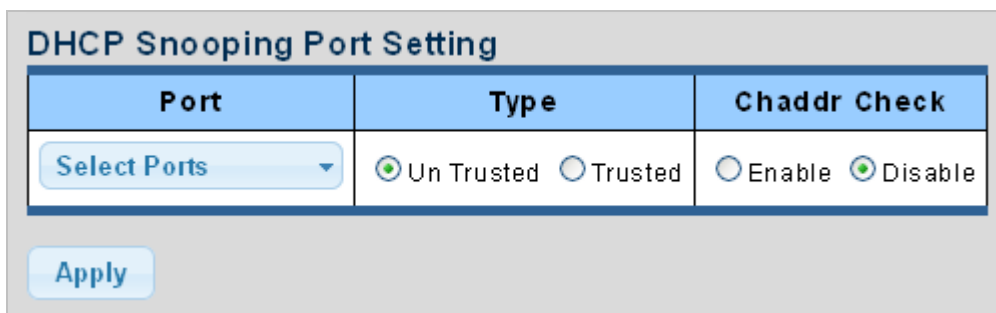

Figure 4-9-37 DHCP Snooping Port Setting Page Screenshot



The page includes the following fields:

Object	Description
• Port	Select port from this drop-down list
• Type	Indicates the DHCP snooping port mode. Possible port modes are: <ul style="list-style-type: none"> <li>■ <b>Trusted</b>: Configures the port as trusted sources of the DHCP message.</li> <li>■ <b>Untrusted</b>: Configures the port as untrusted sources of the DHCP message.</li> </ul>
• Chaddr Check	Indicates that the Chaddr check function is enabled on selected port. Chaddr: Client hardware address.

**Buttons**

**Apply**: Click to apply changes.

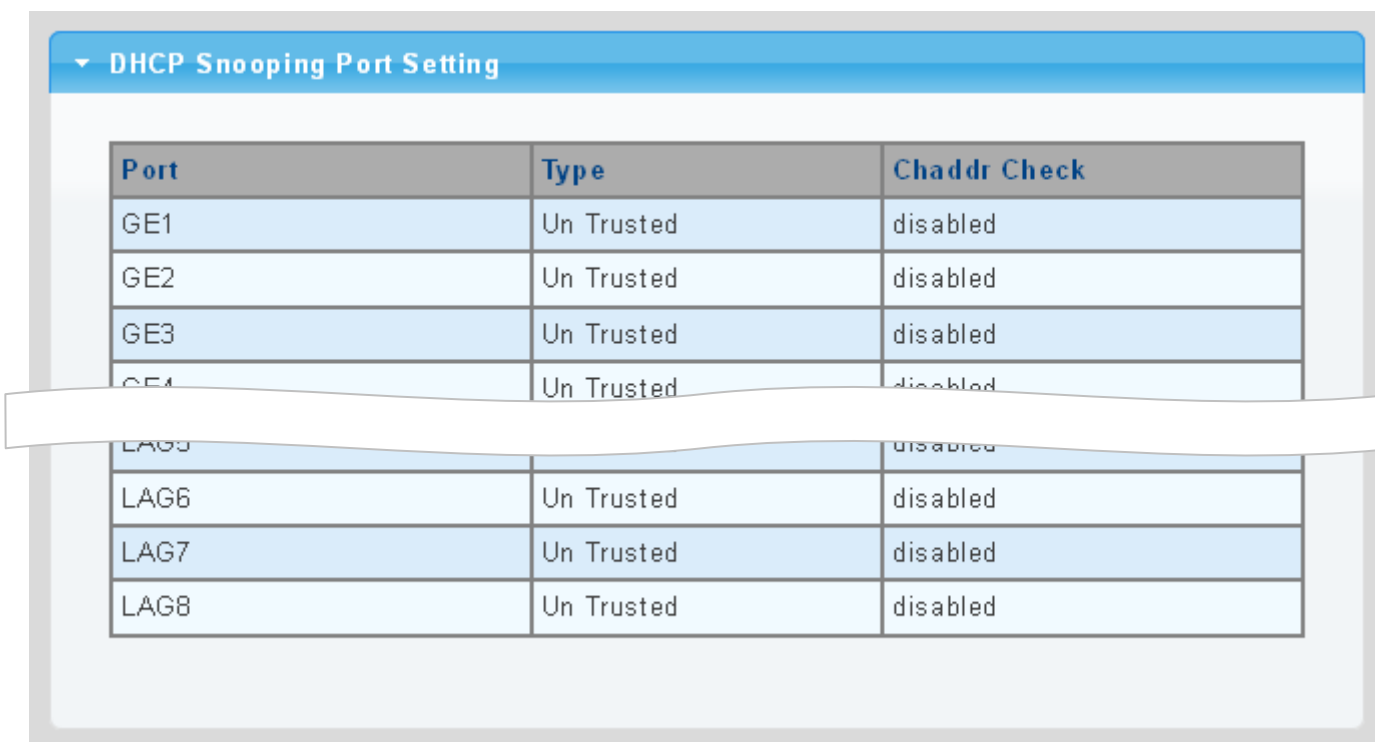

**Figure 4-9-38** DHCP Snooping Port Setting Page Screenshot

The page includes the following fields:

Object	Description
• Port	The switch port number of the logical port
• Type	Displays the current type
• Chaddr Check	Displays the current chaddr check

### 4.9.7.5 Statistics

The DHCP Snooping Statistics screen in [Figure 4-9-39](#) appears.

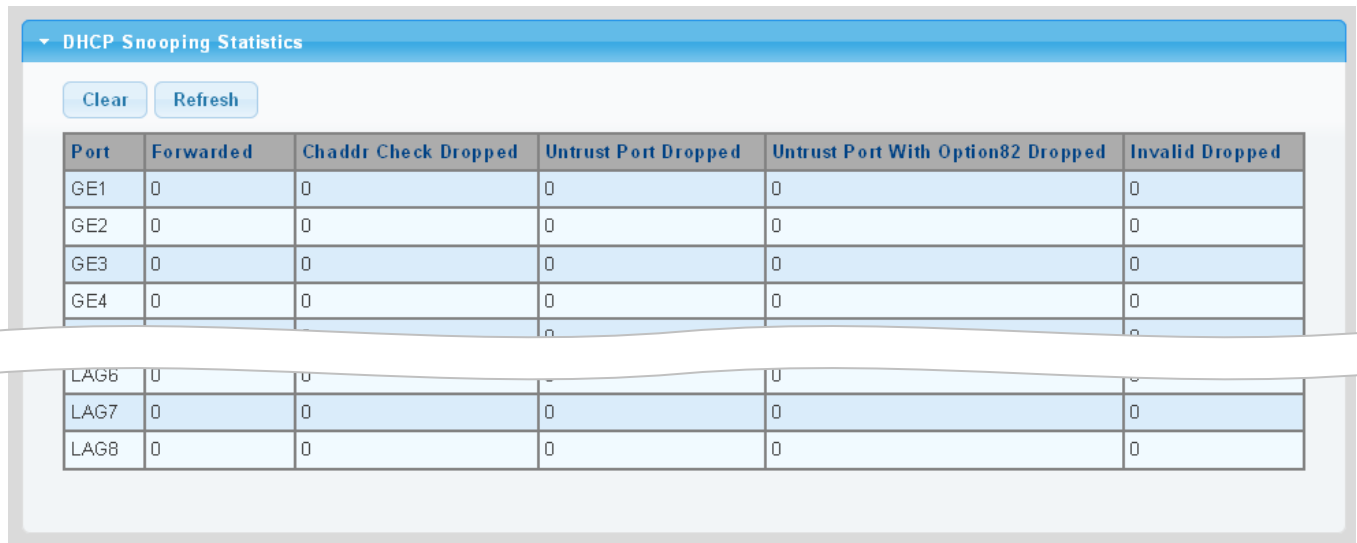

Port	Forwarded	Chaddr Check Dropped	Untrust Port Dropped	Untrust Port With Option82 Dropped	Invalid Dropped
GE1	0	0	0	0	0
GE2	0	0	0	0	0
GE3	0	0	0	0	0
GE4	0	0	0	0	0
LAG6	0	0	0	0	0
LAG7	0	0	0	0	0
LAG8	0	0	0	0	0

Figure 4-9-39 DHCP Snooping Statistics Page Screenshot

The page includes the following fields:

Object	Description
• Port	The switch port number of the logical port
• Forwarded	Displays the current forwarded
• Chaddr Check Dropped	Displays the chaddr check dropped
• Untrust Port Dropped	Displays untrust port dropped
• Untrust Port with Option82 Dropped	Displays untrust port with option82 dropped
• Invalid Dropped	Displays invalid dropped

#### Buttons

**Clear** : Click to clear the statistics.

**Refresh** : Click to refresh the statistics.

### 4.9.7.6 Database Agent

#### Overview of the DHCP Snooping Database Agent

When DHCP snooping is enabled, the switch uses the DHCP snooping binding database to store information about untrusted interfaces. The database can have up to 8192 bindings.

Each database entry (*binding*) has an IP address, an associated MAC address, the lease time (in hexadecimal format), the interface to which the binding applies, and the VLAN to which the interface belongs. A *checksum* value, the end of each entry, is the number of bytes from the start of the file to end of the entry. Each entry is 72 bytes, followed by a space and then the checksum value.

To keep the bindings when the switch reloads, you must use the DHCP snooping database agent. If the agent is disabled, dynamic ARP or IP source guard is enabled, and the DHCP snooping binding database has dynamic bindings, the switch loses its connectivity. If the agent is disabled and only DHCP snooping is enabled, the switch does not lose its connectivity, but DHCP snooping might not prevent DHCP spoofing attacks.

The database agent stores the bindings in a file at a configured location. When reloading, the switch reads the binding file to build the DHCP snooping binding database. The switch keeps the file current by updating it when the database changes.

When a switch learns of new bindings or when it loses bindings, the switch immediately updates the entries in the database. The switch also updates the entries in the binding file. The frequency at which the file is updated is based on a configurable delay, and the updates are batched. If the file is not updated in a specified time (set by the write-delay and abort-timeout values), the update stops.

The DHCP Snooping Database and Information screens in [Figure 4-9-40](#) & [Figure 4-9-41](#) appear.

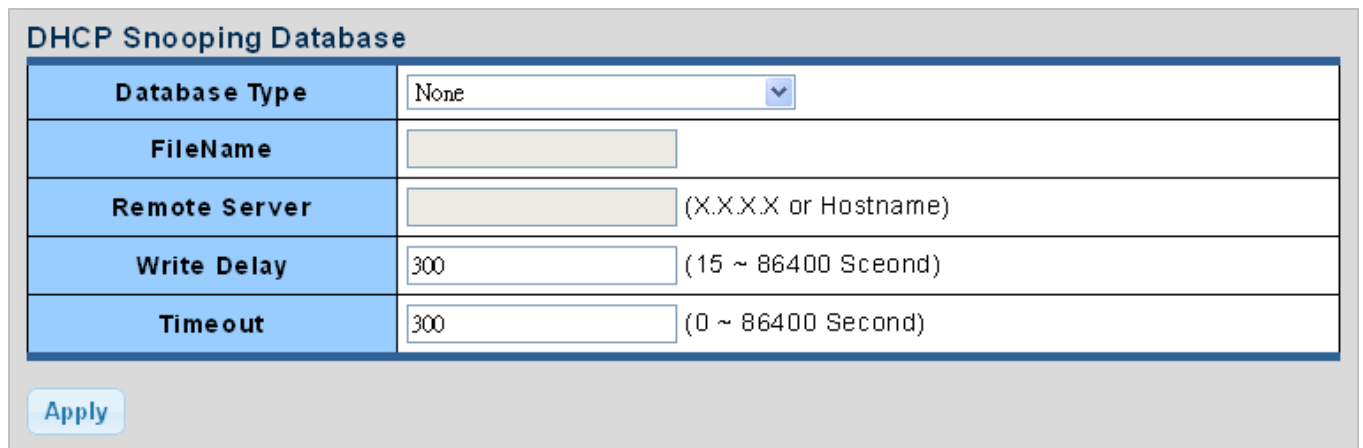

DHCP Snooping Database	
Database Type	None
FileName	
Remote Server	(X.X.X.X or Hostname)
Write Delay	300 (15 ~ 86400 Second)
Time out	300 (0 ~ 86400 Second)

Apply

Figure 4-9-40 DHCP Snooping Database Setting Page Screenshot

The page includes the following fields:

Object	Description
• Database Type	Select database type
• File Name	The name of file image

• <b>Remote Server</b>	Fill in your remote server IP address
• <b>Write Delay</b>	Specify the duration for which the transfer should be delayed after the binding database changes. The range is from 15 to 86400 seconds. The default is 300 seconds (5 minutes).
• <b>Timeout</b>	Specify when to stop the database transfer process after the binding database changes.  The range is from 0 to 86400. Use 0 for an infinite duration. The default is 300 seconds (5 minutes).

**Buttons**

**Apply**: Click to apply changes.

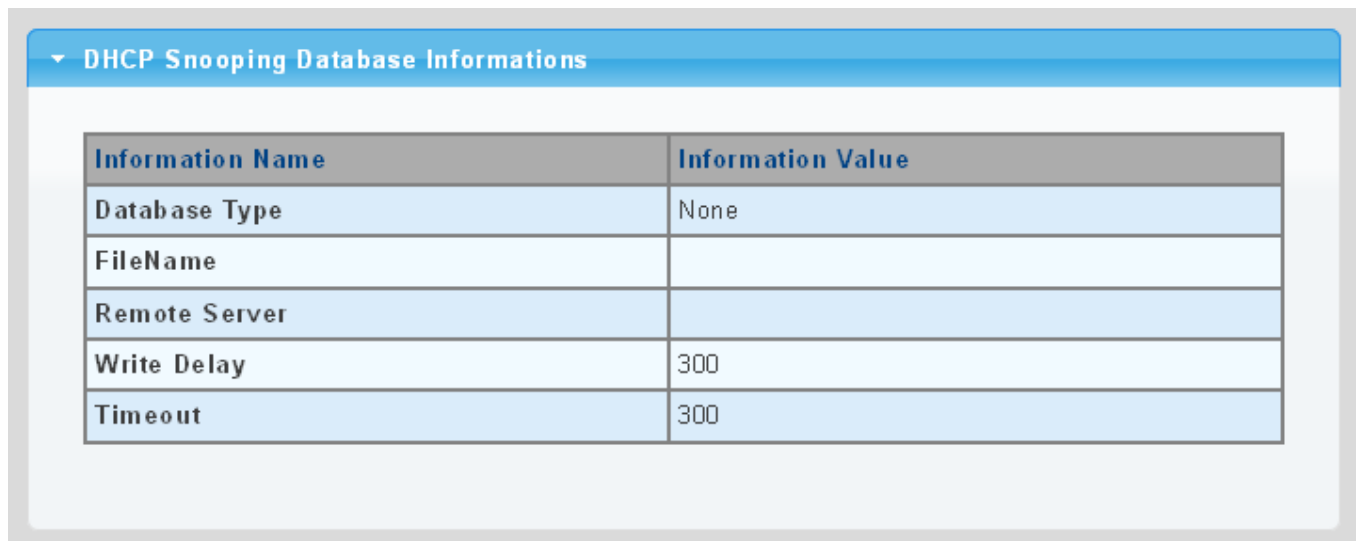

Figure 4-9-41 DHCP Snooping Database Information Page Screenshot

The page includes the following fields:

Object	Description
• <b>Database Type</b>	Displays the current database type
• <b>File Name</b>	Displays the current file name
• <b>Remote Server</b>	Displays the current remote server
• <b>Write Delay</b>	Displays the current write delay
• <b>Timeout</b>	Displays the current timeout

### 4.9.7.7 Rate Limit

After enabling DHCP snooping, the switch will monitor all the DHCP messages and implement software transmission. The DHCP Rate Limit Setting and Config screens in [Figure 4-9-42](#) & [Figure 4-9-43](#) appear.

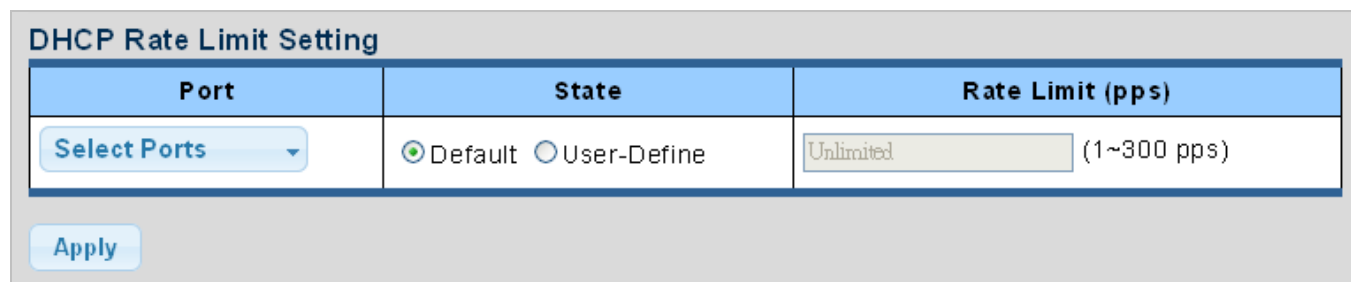

Figure 4-9-42 DHCP Rate Limit Setting Page Screenshot

The page includes the following fields:

Object	Description
• Port	Select port for this drop down list
• State	Set default or user-define
• Rate Limit (pps)	Configure the rate limit for the port policer. The default value is "unlimited". Valid values are in the range 1 to 300.

#### Buttons

: Click to apply changes

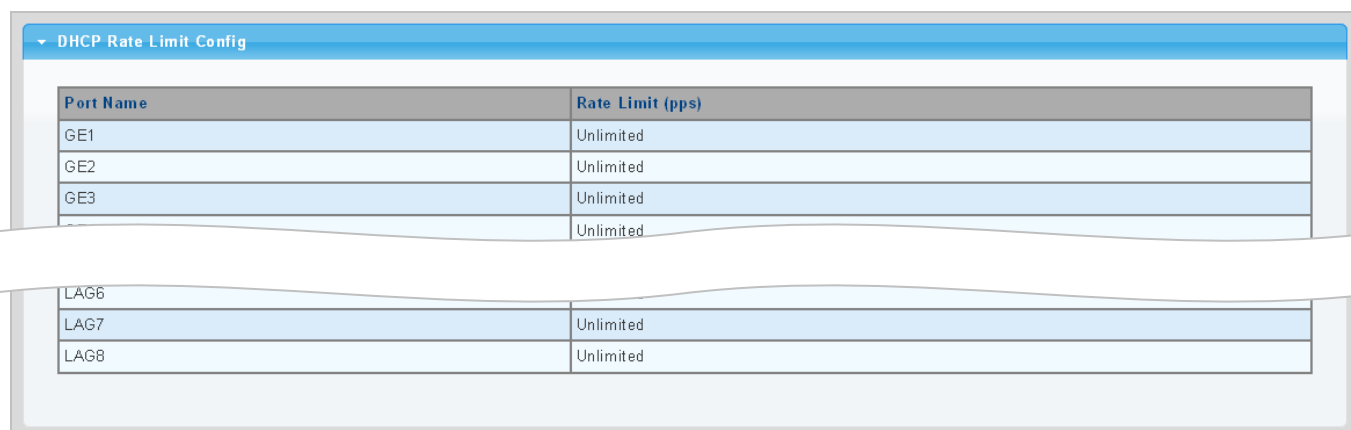

Figure 4-9-43 DHCP Rate Limit Setting Page Screenshot

The page includes the following fields:

Object	Description
• Port	The switch port number of the logical port
• Rate Limit (pps)	Displays the current rate limit

### 4.9.7.8 Option82 Global Setting

DHCP provides a relay mechanism for sending information about the switch and its DHCP clients to DHCP servers. Known as **DHCP Option 82**, it allows compatible DHCP servers to use the information when assigning IP addresses, or to set other services or policies for clients. It is also an effective tool in preventing malicious network attacks from attached clients on DHCP services, such as IP Spoofing, Client Identifier Spoofing, MAC Address Spoofing, and Address Exhaustion.

The **DHCP option 82** enables a DHCP relay agent to insert specific information into a DHCP request packets when forwarding client DHCP packets to a DHCP server and remove the specific information from a DHCP reply packets when forwarding server DHCP packets to a DHCP client. The DHCP server can use this information to implement IP address or other assignment policies. Specifically the option works by setting two sub-options:

- Circuit ID (option 1)
- Remote ID (option2).

The Circuit ID sub-option is supposed to include information specific to which circuit the request came in on.

The Remote ID sub-option was designed to carry information relating to the remote host end of the circuit.

The definition of Circuit ID in the switch is 4 bytes in length and the format is "vlan\_id" "module\_id" "port\_no". The parameter of "vlan\_id" is the first two bytes represent the VLAN ID. The parameter of "module\_id" is the third byte for the module ID (in standalone switch it always equal 0, in switch it means switch ID). The parameter of "port\_no" is the fourth byte and it means the port number.

After enabling DHCP snooping, the switch will monitor all the DHCP messages and implement software transmission. The DHCP Rate Limit Setting and Config screens in [Figure 4-9-44](#) & [Figure 4-9-45](#) appear.

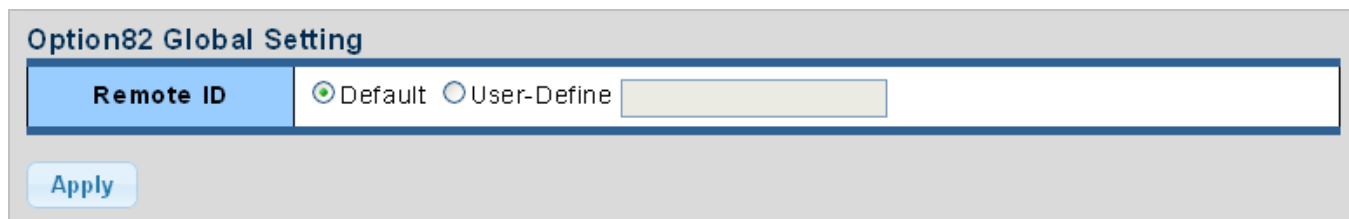

Figure 4-9-44 Option82 Global Setting Page Screenshot

The page includes the following fields:

Object	Description
<ul style="list-style-type: none"> <li>• <b>State</b></li> </ul>	<p>Set the option2 (remote ID option) content of option 82 added by DHCP request packets.</p> <ul style="list-style-type: none"> <li>■ <b>Default</b> means the default VLAN MAC format.</li> <li>■ <b>User-Define</b> means the remote-id content of option 82 specified by users</li> </ul>

#### Buttons

: Click to apply changes.

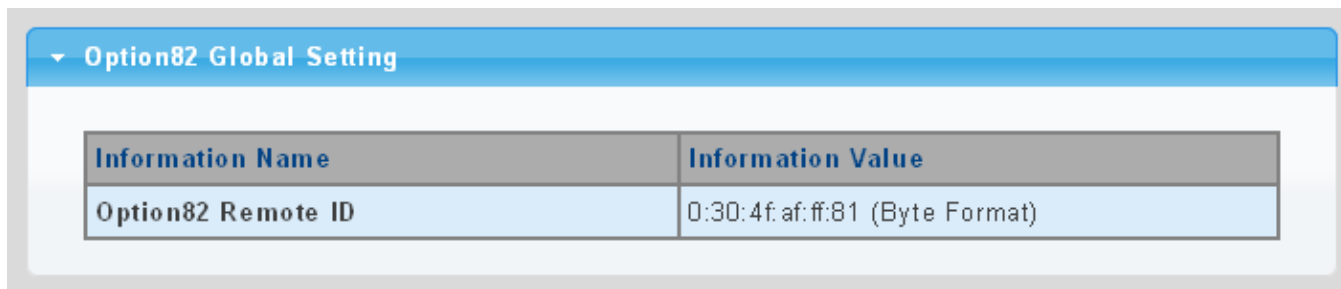

Figure 4-9-45 Option82 Global Setting Page Screenshot

The page includes the following fields:

Object	Description
• Option82 Remote ID	Displays the current option82 remote ID

### 4.9.7.9 Option82 Port Setting

This function is used to set the retransmitting policy of the system for the received DHCP request message which contains option82.

- The **drop** mode means that if the message has option82, then the system will drop it without processing.
- The **keep** mode means that the system will keep the original option82 segment in the message, and forward it to the server to process
- The **replace** mode means that the system will replace the option 82 segment in the existing message with its own option 82, and forward the message to the server to process.

Option82 Port Setting screens in [Figure 4-9-46](#) & [Figure 4-9-47](#) appear.

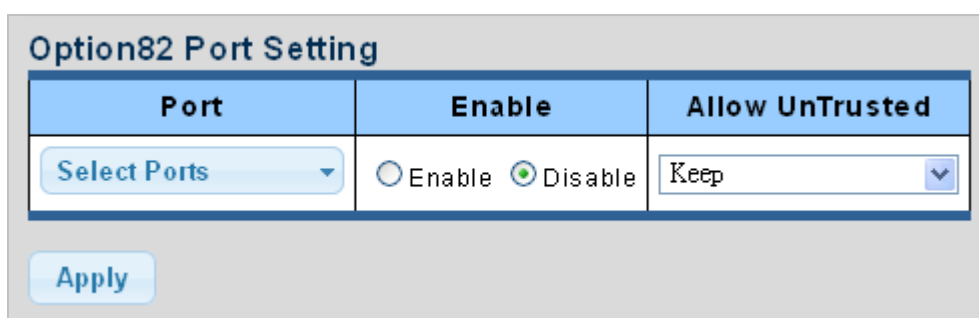

Figure 4-9-46 Option82 Global Setting Page Screenshot

The page includes the following fields:

Object	Description
• Port	Select port for this drop down list
• Enable	Enable or disable option82 function on port
• Allow Untrusted	Select modes for this drop down list. The following modes are available:

	<ul style="list-style-type: none"> <li>■ Drop</li> <li>■ Keep</li> <li>■ Replace</li> </ul>
--	---

**Buttons**

**Apply**: Click to apply changes.

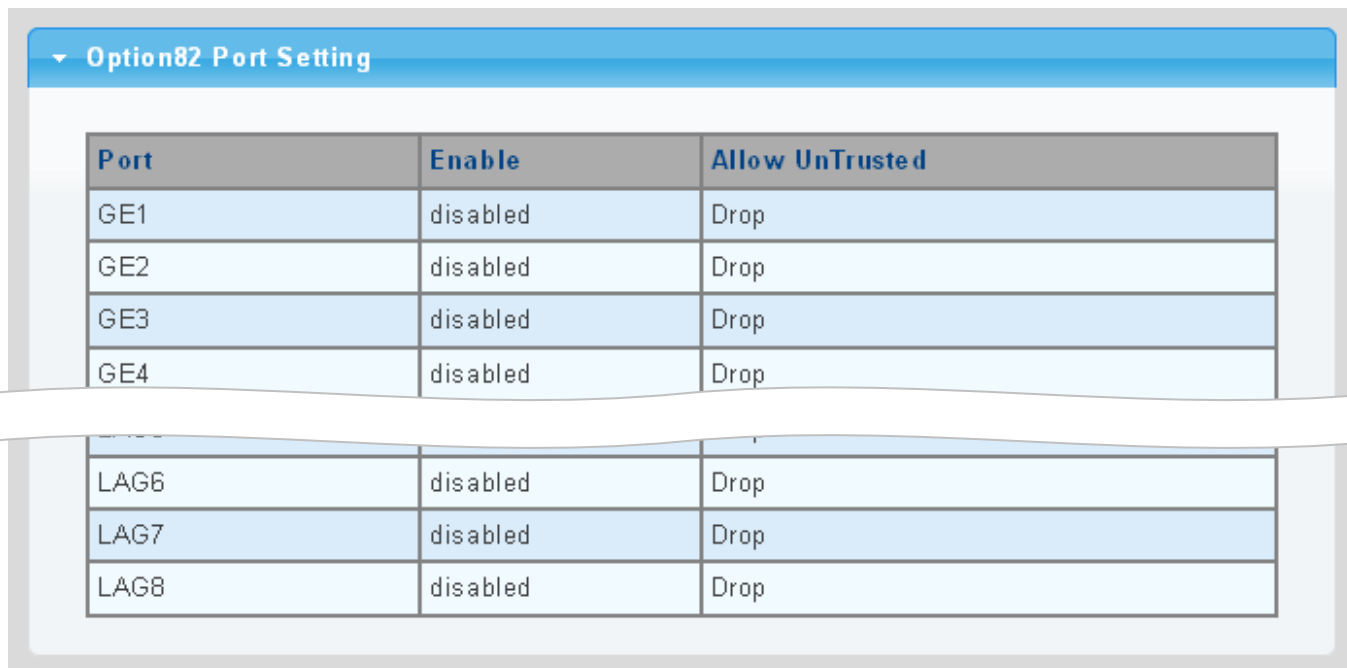

**Figure 4-9-47** Option82 Global Setting Page Screenshot

The page includes the following fields:

Object	Description
• Port	The switch port number of the logical port
• Enable	Displays the current status
• Allow Untrusted	Displays the current untrusted mode



### 4.9.7.10 Option82 Circuit-ID Setting

Set creation method for option82, users can define the parameters of circuit-id suboption by themselves. Option82 Circuit-ID Setting screens in [Figure 4-9-48](#) & [Figure 4-9-49](#) appear.

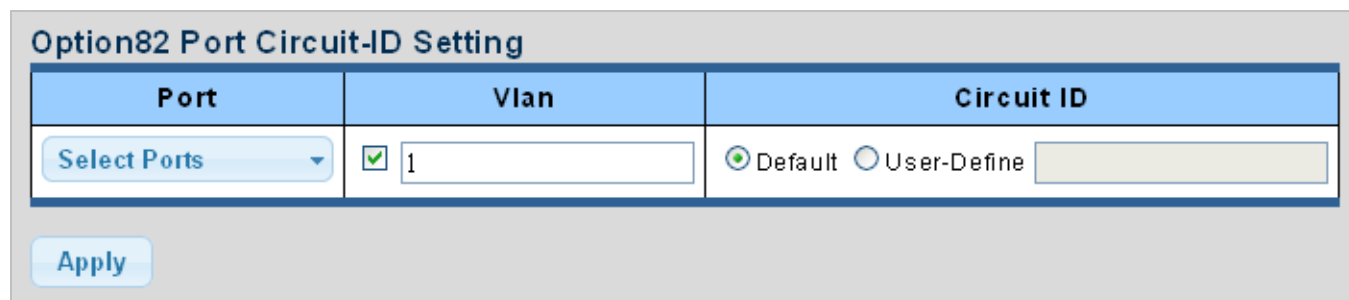

**Figure 4-9-48** Option82 Port Circuit-ID Setting Page Screenshot

The page includes the following fields:

Object	Description
• Port	Select port for this drop down list
• VLAN	Indicates the ID of this particular VLAN
• Circuit ID	Set the option1 (Circuit ID) content of option 82 added by DHCP request packets

#### Buttons

: Click to apply changes.

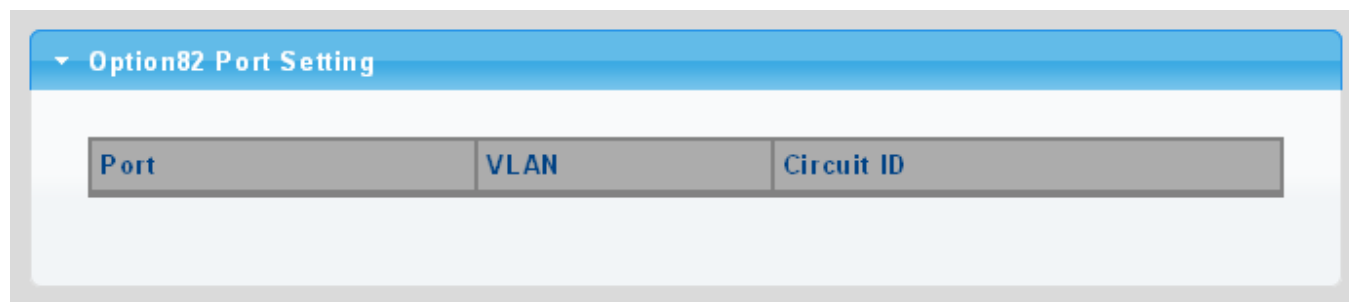

**Figure 4-9-49** Option82 Port Circuit-ID Setting Page Screenshot

The page includes the following fields:

Object	Description
• Port	Displays the current port
• VLAN	Displays the current VLAN
• Circuit ID	Displays the current circuit ID

## 4.9.8 Dynamic ARP Inspection

**Dynamic ARP Inspection (DAI)** is a secure feature. Several types of attacks can be launched against a host or devices connected to Layer 2 networks by "poisoning" the ARP caches. This feature is used to block such attacks. Only valid ARP requests and responses can go through DUT. This page provides ARP Inspection related configuration.



A Dynamic ARP prevents the untrusted ARP packets based on the DHCP Snooping Database.

### 4.9.8.1 Global Setting

DAI Setting and Information screens in [Figure 4-9-50](#) & [Figure 4-9-51](#) appear.



**Figure 4-9-50** DAI Setting Page Screenshot

The page includes the following fields:

Object	Description
• DAI	Enable the Global Dynamic ARP Inspection or disable the Global ARP Inspection

#### Buttons

: Click to apply changes.

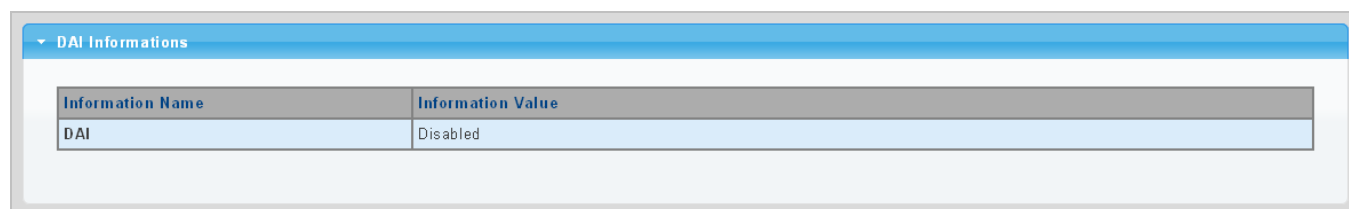

**Figure 4-9-51** DAI Information Page Screenshot

The page includes the following fields:

Object	Description
• DAI	Displays the current DAI status

### 4.9.8.2 VLAN Setting

DAI VLAN Setting screens in [Figure 4-9-52](#) & [Figure 4-9-53](#) appear.

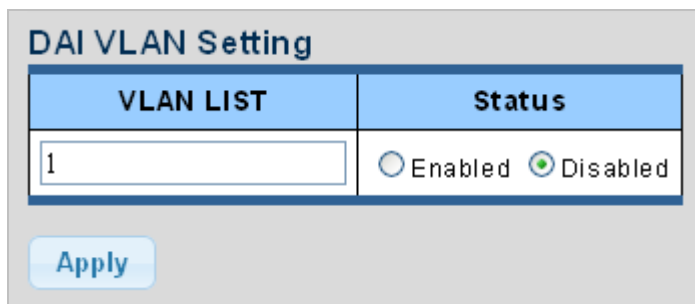

**Figure 4-9-52** DAI VLAN Setting Page Screenshot

The page includes the following fields:

Object	Description
• <b>VLAN ID</b>	Indicates the ID of this particular VLAN
<b>Status</b>	Enables Dynamic ARP Inspection on the specified VLAN Options: <ul style="list-style-type: none"> <li>■ <b>Enable</b></li> <li>■ <b>Disable</b></li> </ul>

#### Buttons

: Click to apply changes.

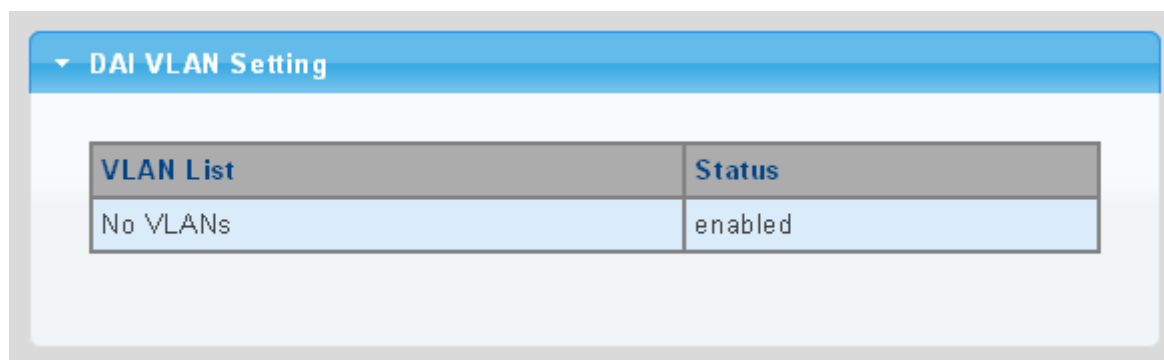

**Figure 4-9-53** DAI VLAN Setting Page Screenshot

The page includes the following fields:

Object	Description
• <b>VLAN List</b>	Displays the current VLAN list
• <b>Status</b>	Displays the current status

### 4.9.8.3 Port Setting

Configures switch ports as DAI trusted or untrusted and check mode. DAI Port Setting screens in [Figure 4-9-54](#) & [Figure 4-9-55](#) appear.

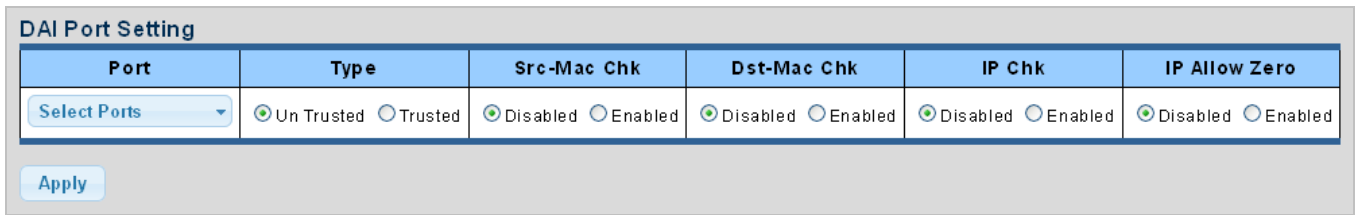

Port	Type	Src-Mac Chk	Dst-Mac Chk	IP Chk	IP Allow Zero
Select Ports	<input checked="" type="radio"/> Un Trusted <input type="radio"/> Trusted	<input checked="" type="radio"/> Disabled <input type="radio"/> Enabled	<input checked="" type="radio"/> Disabled <input type="radio"/> Enabled	<input checked="" type="radio"/> Disabled <input type="radio"/> Enabled	<input checked="" type="radio"/> Disabled <input type="radio"/> Enabled

Apply

**Figure 4-9-54** DAI Port Setting Page Screenshot

The page includes the following fields:

Object	Description
<ul style="list-style-type: none"> <li>• <b>Port</b></li> </ul>	Select port from this drop-down list
<ul style="list-style-type: none"> <li>• <b>Type</b></li> </ul>	Specify ARP Inspection is enabled on which ports. Only when both Global Mode and Port Mode on a given port are enabled, ARP Inspection is enabled on this given port.  Default: All interfaces are untrusted.
<ul style="list-style-type: none"> <li>• <b>Src-Mac Chk</b></li> </ul>	Enable or disable to checks the source MAC address in the Ethernet header against the sender MAC address in the ARP body. This check is performed on both ARP requests and responses. When enabled, packets with different MAC addresses are classified as invalid and are dropped.
<ul style="list-style-type: none"> <li>• <b>Dst-Mac Chk</b></li> </ul>	Enable or disable to checks the destination MAC address in the Ethernet header against the target MAC address in ARP body. This check is performed for ARP responses. When enabled, packets with different MAC addresses are classified as invalid and are dropped.
<ul style="list-style-type: none"> <li>• <b>IP Chk</b></li> </ul>	Enable or disable to checks the source and destination IP addresses of ARP packets. The all-zero, all-one or multicast IP addresses are considered invalid and the corresponding packets are discarded.
<ul style="list-style-type: none"> <li>• <b>IP Allow Zero</b></li> </ul>	Enable or disable to checks all-zero IP addresses.

#### Buttons



: Click to apply changes.

DAI Port Setting

Port	Type	Src-Mac Chk	Dst-Mac Chk	IP Chk	IP Allow Zero
GE1	Un Trusted	disabled	disabled	disabled	disabled
GE2	Un Trusted	disabled	disabled	disabled	disabled
GE3	Un Trusted	disabled	disabled	disabled	disabled
GE4	Un Trusted	disabled	disabled	disabled	disabled
LAG6	Un Trusted	disabled	disabled	disabled	disabled
LAG7	Un Trusted	disabled	disabled	disabled	disabled
LAG8	Un Trusted	disabled	disabled	disabled	disabled

Figure 4-9-55 DAI Port Setting Page Screenshot

The page includes the following fields:

Object	Description
• Port	The switch port number of the logical port
• Type	Display the current port type
• Src-Mac Chk	Displays the current Src-Mac Chk status
• Dst-Mac Chk	Displays the current Dst-Mac Chk status
• IP Chk	Displays the current IP Chk status
• IP Allow Zero	Displays the current IP allow zero status

### 4.9.8.4 Statistics

Configures switch ports as DAI trusted or untrusted and check mode. DAI Port Setting screen in [Figure 4-9-56](#) appears.

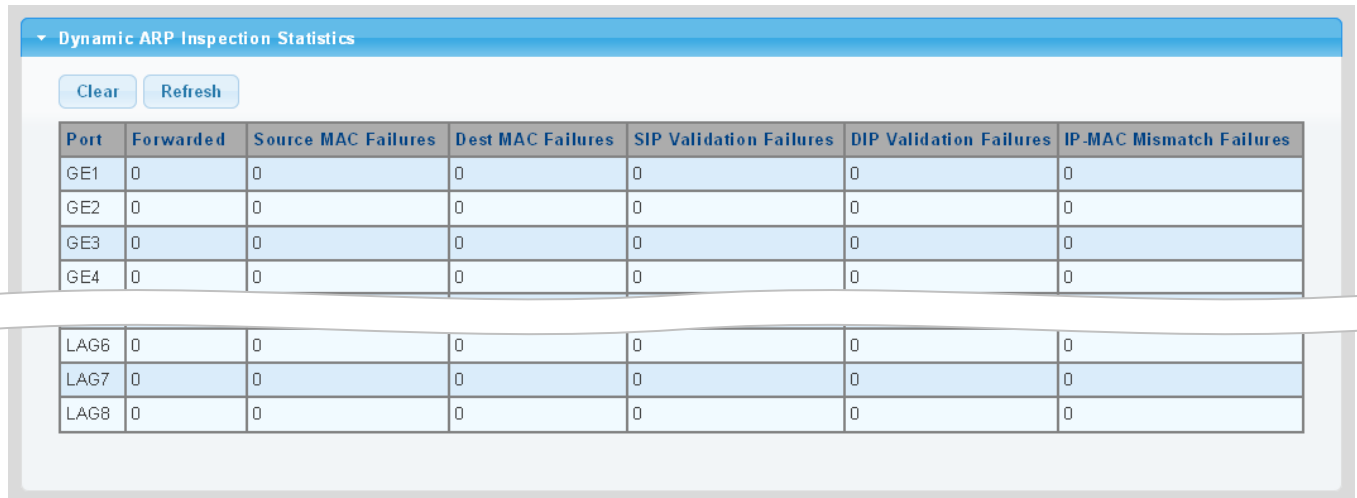

Port	Forwarded	Source MAC Failures	Dest MAC Failures	SIP Validation Failures	DIP Validation Failures	IP-MAC Mismatch Failures
GE1	0	0	0	0	0	0
GE2	0	0	0	0	0	0
GE3	0	0	0	0	0	0
GE4	0	0	0	0	0	0
LAG6	0	0	0	0	0	0
LAG7	0	0	0	0	0	0
LAG8	0	0	0	0	0	0

**Figure 4-9-56** DAI Port Setting Page Screenshot

The page includes the following fields:

Object	Description
• <b>Port</b>	The switch port number of the logical port
• <b>Forwarded</b>	Displays the current forwarded
<b>Source MAC Failures</b>	Displays the current source MAC failures
• <b>Dest MAC Failures</b>	Displays the current source MAC failures
• <b>SIP Validation Failures</b>	Displays the current SIP Validation failures
• <b>DIP Validation Failures</b>	Displays the current DIP Validation failures
• <b>IP-MAC Mismatch Failures</b>	Displays the current IP-MAC mismatch failures

#### Buttons

**Clear** : Click to clear the statistics.

**Refresh** : Click to refresh the statistics.

### 4.9.8.5 Rate Limit

The ARP Rate Limit Setting and Config screens in [Figure 4-9-57](#) & [Figure 4-9-58](#) appear.

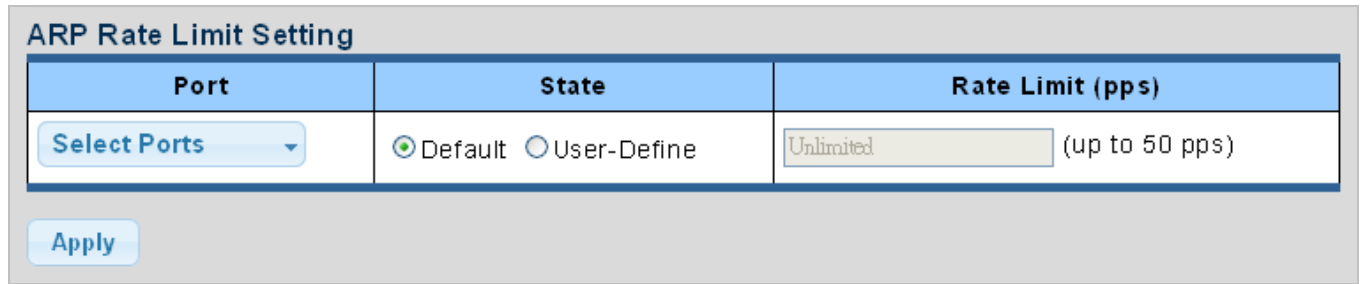

The screenshot shows the 'ARP Rate Limit Setting' configuration page. It features three main sections: 'Port', 'State', and 'Rate Limit (pps)'. The 'Port' section has a dropdown menu labeled 'Select Ports'. The 'State' section has two radio buttons: 'Default' (selected) and 'User-Define'. The 'Rate Limit (pps)' section has a text input field containing 'Unlimited' and a note '(up to 50 pps)'. An 'Apply' button is located at the bottom left of the configuration area.

Figure 4-9-57 ARP Rate Limit Setting Page Screenshot

The page includes the following fields:

Object	Description
• Port	Select port from this drop-down list
• State	Set default or user-define
• Rate Limit (pps)	Configures the rate limit for the port policer. The default value is "unlimited".

#### Buttons

: Click to apply changes.

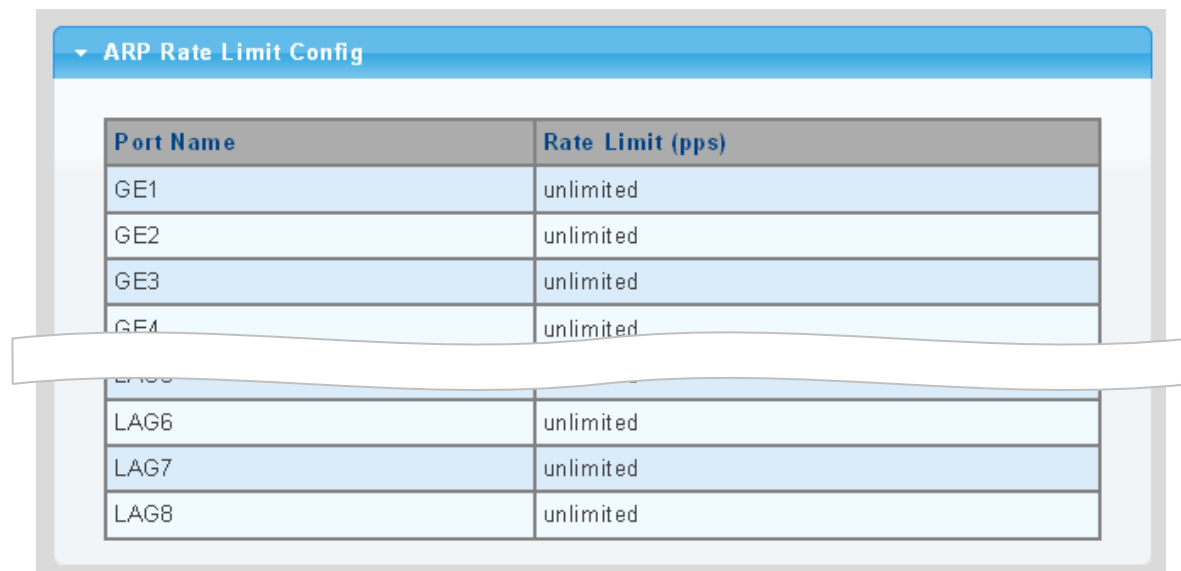

The screenshot shows the 'ARP Rate Limit Config' page, which displays a table of port configurations. The table has two columns: 'Port Name' and 'Rate Limit (pps)'. The rows list ports GE1 through GE4, and LAG6 through LAG8, all with a rate limit of 'unlimited'. A white banner is overlaid on the table.

Port Name	Rate Limit (pps)
GE1	unlimited
GE2	unlimited
GE3	unlimited
GE4	unlimited
LAG6	unlimited
LAG7	unlimited
LAG8	unlimited

Figure 4-9-58 ARP Rate Limit Setting Page Screenshot

The page includes the following fields:

Object	Description
• Port	The switch port number of the logical port
• Rate Limit (pps)	Displays the current rate limit

### 4.9.9 IP Source Guard

IP Source Guard is a secure feature used to restrict IP traffic on DHCP snooping untrusted ports by filtering traffic based on the DHCP Snooping Table or manually configured IP Source Bindings. It helps prevent IP spoofing attacks when a host tries to spoof and use the IP address of another host.

After receiving a packet, the port looks up the key attributes (including IP address, MAC address and VLAN tag) of the packet in the binding entries of the IP source guard. If there is a matching entry, the port will forward the packet. Otherwise, the port will abandon the packet.

IP source guard filters packets based on the following types of binding entries:

- IP-port binding entry
- MAC-port binding entry
- IP-MAC-port binding entry

### IP Source Guard Overview

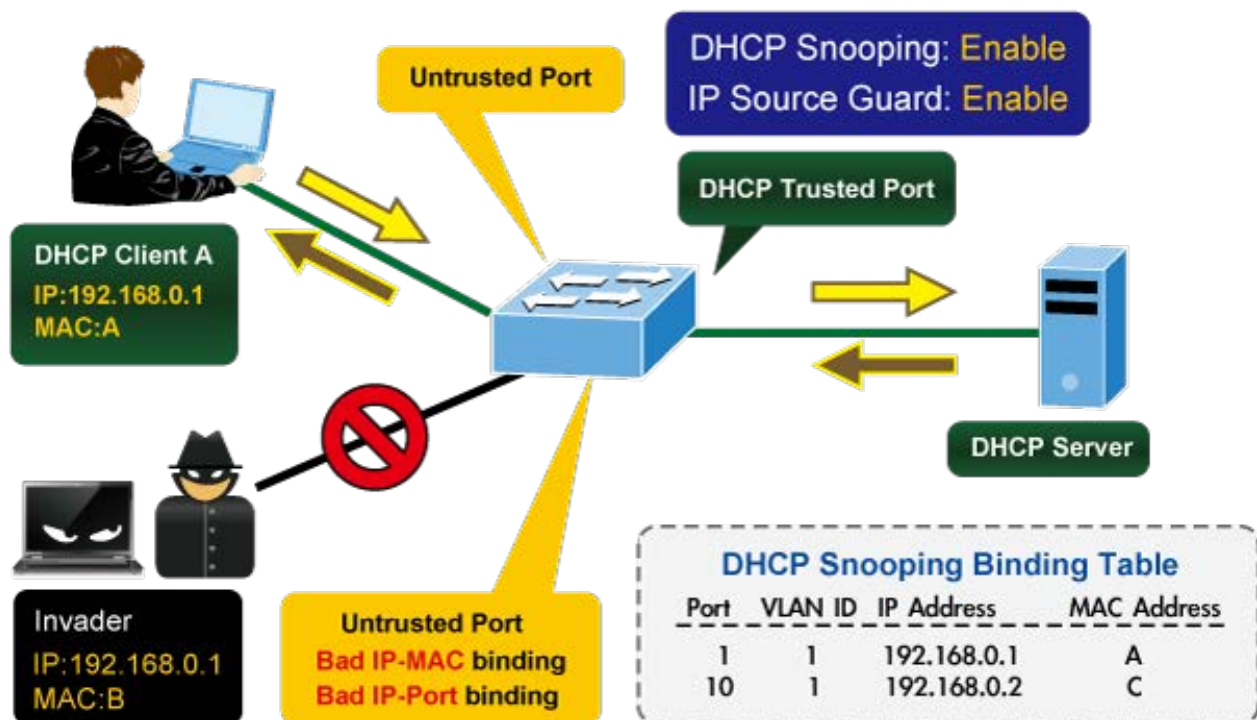



### 4.9.9.1 Port Settings

IP Source Guard is a secure feature used to restrict IP traffic on **DHCP snooping untrusted ports** by filtering traffic based on the DHCP Snooping Table or manually configured IP Source Bindings. It helps prevent IP spoofing attacks when a host tries to spoof and use the IP address of another host.

The IP Source Guard Port Setting and Information screens in [Figure 4-9-60](#) & [Figure 4-9-61](#) appear.

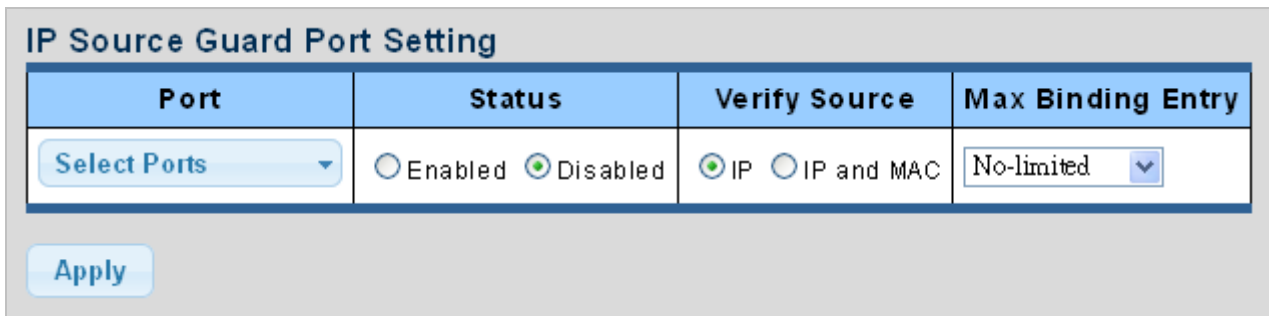

**Figure 4-9-60** IP Source Guard Port Setting Page Screenshot

The page includes the following fields:

Object	Description
<ul style="list-style-type: none"> <li>• <b>Port</b></li> </ul>	Select port from this drop-down list
<ul style="list-style-type: none"> <li>• <b>Status</b></li> </ul>	Enable or disable the IP source guard
<ul style="list-style-type: none"> <li>• <b>Verify Source</b></li> </ul>	Configures the switch to filter inbound traffic based IP address, or IP address and MAC address. <ul style="list-style-type: none"> <li>■ <b>None</b> Disables IP source guard filtering on the Industrial Managed Switch.</li> <li>■ <b>IP</b> Enables traffic filtering based on IP addresses stored in the binding table.</li> <li>■ <b>IP and MAC</b> Enables traffic filtering based on IP addresses and corresponding MAC addresses stored in the binding table.</li> </ul>
<ul style="list-style-type: none"> <li>• <b>Max Binding Entry</b></li> </ul>	The maximum number of IP source guard that can be secured on this port

#### Buttons



: Click to apply changes.

IP Source Guard Port Information

Port	Status	Verify Source	Max Binding Entry	Current Binding Entry
GE1	disabled	IP	No-limited	0
GE2	disabled	IP	No-limited	0
GE3	disabled	IP	No-limited	0
GE4	disabled	IP	No-limited	0
LAG6	disabled	IP	No-limited	0
LAG7	disabled	IP	No-limited	0
LAG8	disabled	IP	No-limited	0

Figure 4-9-61 IP Source Guard Port Setting Page Screenshot

The page includes the following fields:

Object	Description
• Port	The switch port number of the logical port
• Status	Displays the current status
• Verify Source	Displays the current verify source
• Max Binding Entry	Displays the current max binding entry
• Current Binding Entry	Displays the current binding entry

### 4.9.9.2 Binding Table

The IP Source Guard Static Binding Entry and Table Status screens in [Figure 4-9-62](#) & [Figure 4-9-63](#) appear.

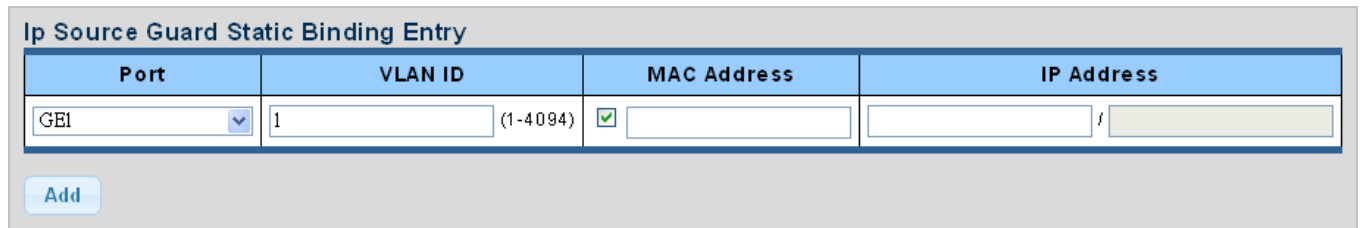

**Figure 4-9-62** IP Source Guard Static Binding Entry Page Screenshot

The page includes the following fields:

Object	Description
• Port	Select port from this drop-down list
• VLAN ID	Indicates the ID of this particular VLAN
• MAC Address	Sourcing MAC address is allowed
• IP Address	Sourcing IP address is allowed

#### Buttons

: Click to add authentication list

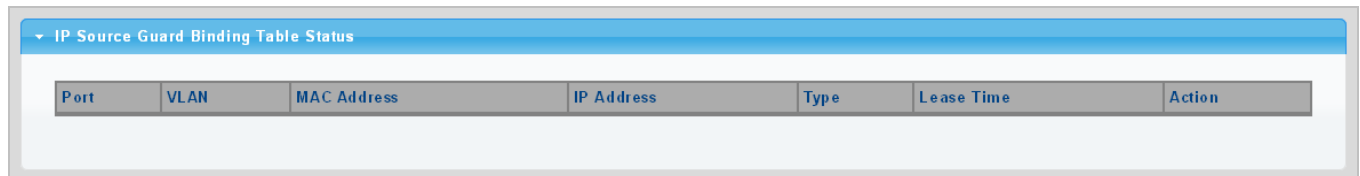

**Figure 4-9-63** IP Source Guard Binding Table Status Page Screenshot

The page includes the following fields:

Object	Description
• Port	Displays the current port
• VLAN ID	Displays the current VLAN
• MAC Address	Displays the current MAC address
• IP Address	Displays the current IP Address
• Type	Displays the current entry type
• Lease Time	Displays the current lease time
• Action	Click  to delete IP source guard binding table status entry

### 4.9.10 Port Security

This page allows you to configure the Port Security Limit Control system and port settings. Limit Control allows for limiting the number of users on a given port. A user is identified by a MAC address and VLAN ID. If Limit Control is enabled on a port, the limit specifies the maximum number of users on the port. If this number is exceeded, an action is taken. The action can be one of four different as described below.

The Limit Control module is one of the modules that utilize a lower-layer module while the Port Security module manages MAC addresses learned on the port.

The Limit Control configuration consists of two sections, a system- and a port-wid. The IP Source Guard Static Binding Entry and Table Status screens in [Figure 4-9-64](#) & [Figure 4-9-65](#) appear.

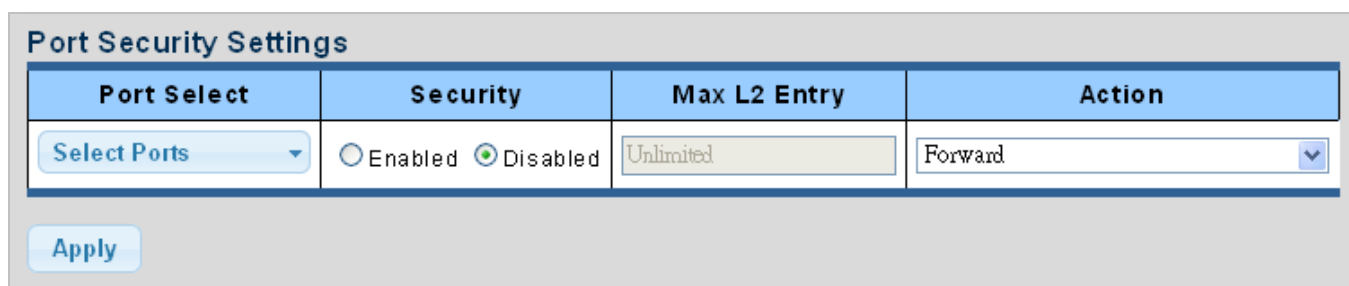

Figure 4-9-64 Port Security Setting Page Screenshot

The page includes the following fields:

Object	Description
<ul style="list-style-type: none"> <li>• <b>Port</b></li> </ul>	Select port from this drop-down list
<ul style="list-style-type: none"> <li>• <b>Security</b></li> </ul>	Enable or disable the port security
<ul style="list-style-type: none"> <li>• <b>Mac L2 Entry</b></li> </ul>	<p>The maximum number of MAC addresses that can be secured on this port. If the limit is exceeded, the corresponding action is taken.</p> <p>The switch is "born" with a total number of MAC addresses from which all ports draw whenever a new MAC address is seen on a Port Security-enabled port. Since all ports draw from the same pool, it may happen that a configured maximum cannot be granted, if the remaining ports have already used all available MAC addresses.</p>
<ul style="list-style-type: none"> <li>• <b>Action</b></li> </ul>	<p>If Limit is reached, the switch can take one of the following actions:</p> <ul style="list-style-type: none"> <li>■ <b>Forward:</b> Do not allow more than Limit MAC addresses on the port, but take no further action.</li> <li>■ <b>Shutdown:</b> If Limit + 1 MAC addresses is seen on the port, shut down the port. This implies that all secured MAC addresses will be removed from the port, and no new will be learned. Even if the link is physically disconnected</li> </ul>

	<p>and reconnected on the port (by disconnecting the cable), the port will remain shut down. There are three ways to re-open the port:</p> <ol style="list-style-type: none"> <li>1) Disable and re-enable Limit Control on the port or the switch,</li> <li>2) Click the Reopen button.</li> </ol> <ul style="list-style-type: none"> <li>■ <b>Discard</b>: If Limit + 1 MAC addresses is seen on the port, it will trigger the action that do not learn the new MAC and drop the package.</li> </ul>
--	--

**Buttons**

: Click to apply changes.

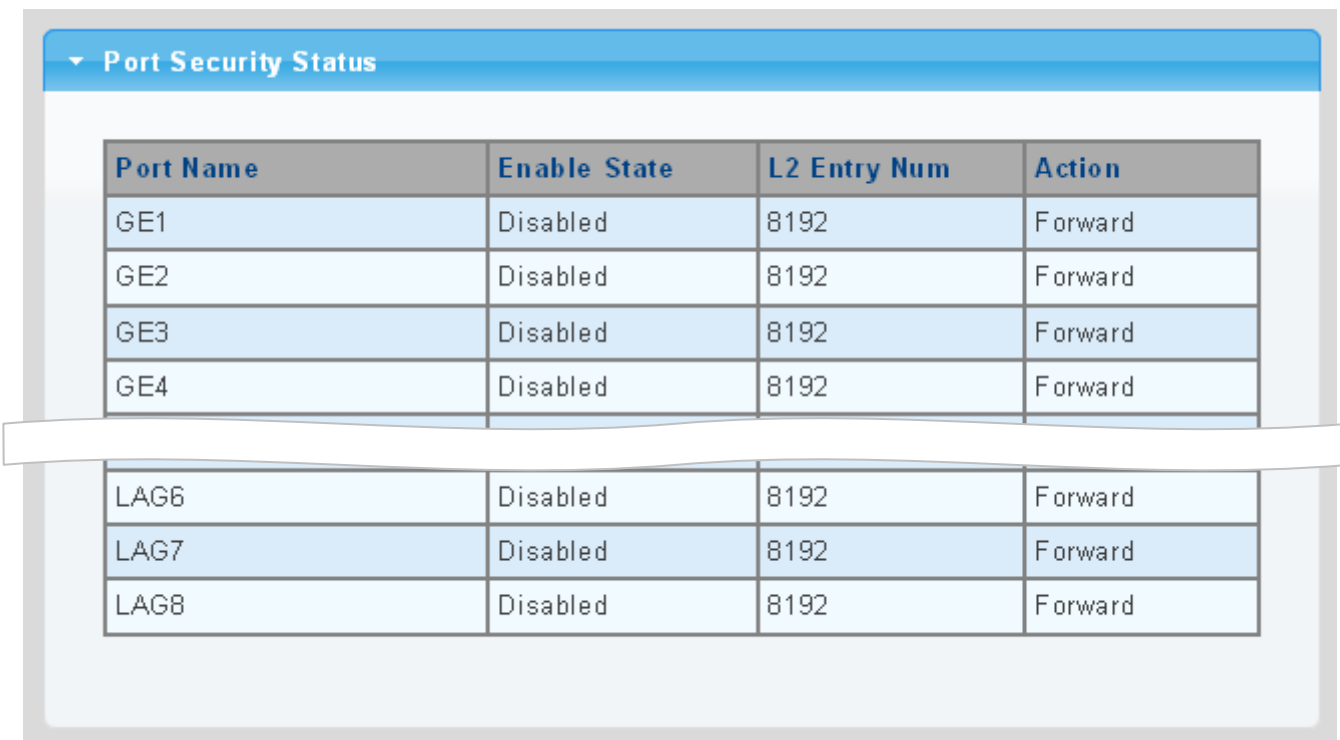

**Figure 4-9-65** Port Security Status Page Screenshot

The page includes the following fields:

Object	Description
• <b>Port Name</b>	The switch port number of the logical port
• <b>Enable State</b>	Displays the current per port security status
• <b>L2 Entry Num</b>	Displays the current L2 entry number
• <b>Action</b>	Displays the current action

### 4.9.11 DoS

The DoS is short for **Denial of Service**, which is a simple but effective destructive attack on the internet. The server under DoS attack will drop normal user data packet due to non-stop processing the attacker's data packet, leading to the denial of the service and worse can lead to leak of sensitive data of the server.

Security feature refers to applications such as protocol check which is for protecting the server from attacks such as DoS. The protocol check allows the user to drop matched packets based on specified conditions. The security features provide several simple and effective protections against Dos attacks while acting no influence on the linear forwarding performance of the switch.

#### 4.9.11.1 Global DoS Setting

The Global DoS Setting and Information screens in [Figure 4-9-66](#) & [Figure 4-9-67](#) appear.

Global DoS Setting	
DMAC = SMAC	<input checked="" type="radio"/> Enabled <input type="radio"/> Disabled
Land	<input checked="" type="radio"/> Enabled <input type="radio"/> Disabled
UDP Blat	<input checked="" type="radio"/> Enabled <input type="radio"/> Disabled
TCP Blat	<input checked="" type="radio"/> Enabled <input type="radio"/> Disabled
POD	<input checked="" type="radio"/> Enabled <input type="radio"/> Disabled
IPv6 Min Fragment	<input checked="" type="radio"/> Enabled <input type="radio"/> Disabled Byte: <input type="text" value="1240"/> (0-65535)
ICMP Fragments	<input checked="" type="radio"/> Enabled <input type="radio"/> Disabled
IPv4 Ping Max Size	<input checked="" type="radio"/> Enabled <input type="radio"/> Disabled
IPv6 Ping Max Size	<input checked="" type="radio"/> Enabled <input type="radio"/> Disabled
Ping Max Size Setting	Byte: <input type="text" value="512"/> (0-65535)
Smurf Attack	<input checked="" type="radio"/> Enabled <input type="radio"/> Disabled Netmask Length: <input type="text" value="0"/> (0-32)
TCP Min Hdr Size	<input checked="" type="radio"/> Enabled <input type="radio"/> Disabled Bytes: <input type="text" value="20"/> (0-31)
TCP-SYN(SPORT<1024)	<input checked="" type="radio"/> Enabled <input type="radio"/> Disabled
Null Scan Attack	<input checked="" type="radio"/> Enabled <input type="radio"/> Disabled
X-Mas Scan Attack	<input checked="" type="radio"/> Enabled <input type="radio"/> Disabled
TCP SYN-FIN Attack	<input checked="" type="radio"/> Enabled <input type="radio"/> Disabled
TCP SYN-RST Attack	<input checked="" type="radio"/> Enabled <input type="radio"/> Disabled
TCP Fragment (Offset = 1)	<input checked="" type="radio"/> Enabled <input type="radio"/> Disabled

Figure 4-9-66 Global DoS Setting Page Screenshot

The page includes the following fields:

Object	Description
• <b>DMAC = SMAC</b>	Enable or disable DoS check mode by DMAC = SMAC
• <b>Land</b>	Enable or disable DoS check mode by land
• <b>UDP Blat</b>	Enable or disable DoS check mode by UDP blat
• <b>TCP Blat</b>	Enable or disable DoS check mode by TCP blat
• <b>POD</b>	Enable or disable DoS check mode by POD
• <b>IPv6 Min Fragment</b>	Enable or disable DoS check mode by IPv6 min fragment
• <b>ICMP Fragments</b>	Enable or disable DoS check mode by ICMP fragment
• <b>IPv4 Ping Max Size</b>	Enable or disable DoS check mode by IPv4 ping max size
• <b>IPv6 Ping Max Size</b>	Enable or disable DoS check mode by IPv6 ping max size
• <b>Ping Max Size Setting</b>	Set the max size for ping
• <b>Smurf Attack</b>	Enable or disable DoS check mode by smurf attack
• <b>TCP Min Hdr Size</b>	Enable or disable DoS check mode by TCP min hdr size
• <b>TCP-SYN (SPORT &lt; 1024)</b>	Enable or disable DoS check mode by TCP-syn (sport < 1024)
• <b>Null Scan Attack</b>	Enable or disable DoS check mode by null scan attack
• <b>X-Mas Scan Attack</b>	Enable or disable DoS check mode by x-mas scan attack
• <b>TCP SYN-FIN Attack</b>	Enable or disable DoS check mode by TCP syn-fin attack
• <b>TCP SYN-RST Attack</b>	Enable or disable DoS check mode by TCP syn-rst attack
• <b>TCP Fragment (Offset = 1)</b>	Enable or disable DoS check mode by TCP fragment (offset = 1)

**Buttons**

: Click to apply changes.

▼ DoS Informations

Information Name	Information Value
DMAC = SMAC	Enabled
Land Attack	Enabled
UDP Blat	Enabled
TCP Blat	Enabled
POD (Ping of Death)	Enabled
IPv6 Min Fragment Size	Enabled (1240 Bytes)
ICMP Fragment Packets	Enabled
IPv4 Ping Max Packet Size	Enabled (512 Bytes)
IPv6 Ping Max Packet Size	Enabled (512 Bytes)
Smurf Attack	Enabled (Netmask Length: 0)
TCP Min Header Length	Enabled (20 Bytes)
TCP Syn (SPORT < 1024)	Enabled
Null Scan Attack	Enabled
X-Mas Scan Attack	Enabled
TCP SYN-FIN Attack	Enabled
TCP SYN-RST Attack	Enabled
TCP Fragment (Offset = 1)	Enabled

Figure 4-9-67 DoS Information Page Screenshot

The page includes the following fields:

Object	Description
• <b>DMAC = SMAC</b>	Displays the current DMAC = SMAC status
• <b>Land Attach</b>	Displays the current land attach status
• <b>UDP Blat</b>	Displays the current UDP blat status
• <b>TCP Blat</b>	Displays the current TCP blat status
• <b>POD</b>	Displays the current POD status
• <b>IPv6 Min Fragment</b>	Displays the current IPv6 min fragment status
• <b>ICMP Fragments</b>	Displays the current ICMP fragment status
• <b>IPv4 Ping Max Size</b>	Displays the current IPv4 ping max size status
• <b>IPv6 Ping Max Size</b>	Displays the current IPv6 ping max size status
• <b>Smurf Attack</b>	Displays the current smurf attack status
• <b>TCP Min Header Length</b>	Displays the current TCP min header length
• <b>TCP-SYN (SPORT &lt; 1024)</b>	Displays the current TCP syn status
• <b>Null Scan Attack</b>	Displays the current null scan attack status
• <b>X-mas Scan Attack</b>	Displays the current x-mas scan attack status
• <b>TCP SYN-FIN Attack</b>	Displays the current TCP syn-fin attack status
• <b>TCP SYN-RST Attack</b>	Displays the current TCP syn-rst attack status
• <b>TCP Fragment (Offset = 1)</b>	Displays the TCP fragment (offset = 1) status



### 4.9.11.2 DoS Port Setting

The DoS Port Setting and Status screens in [Figure 4-9-68](#) & [Figure 4-9-69](#) appear.

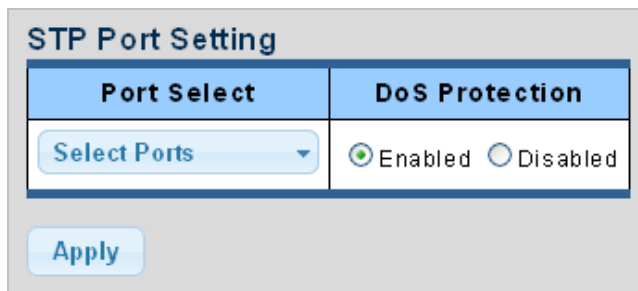

Figure 4-9-68 Port Security Setting Page Screenshot

The page includes the following fields:

Object	Description
• Port Select	Select port from this drop-down list.
• DoS Protection	Enable or disable per port DoS protection.

#### Buttons

: Click to apply changes.

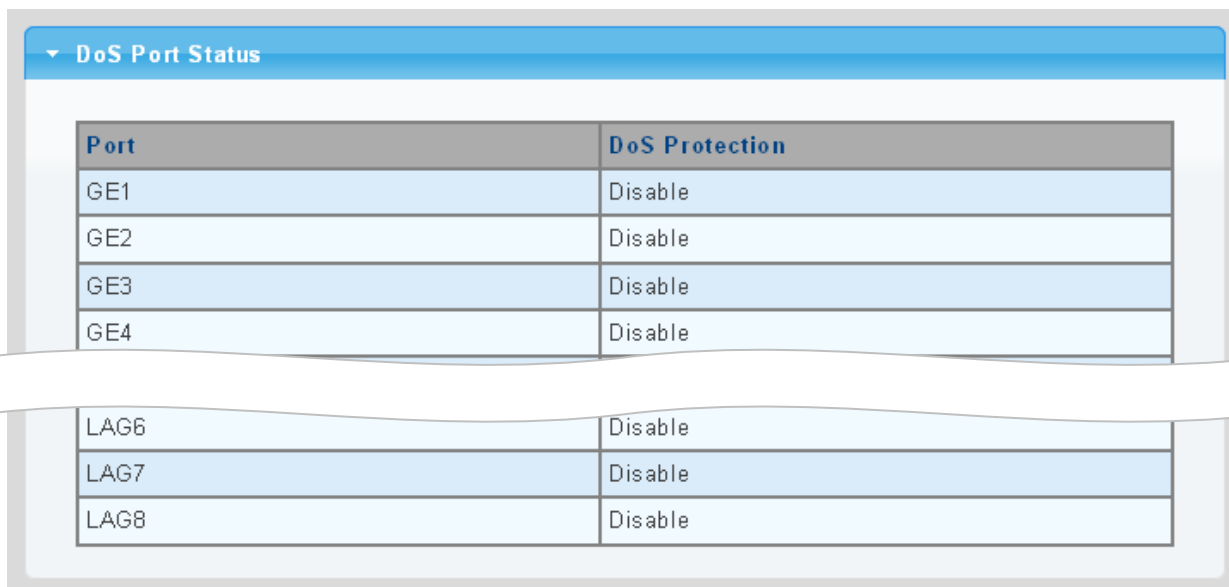

Figure 4-9-68 Port Security Setting Page Screenshot

The page includes the following fields:

Object	Description
• Port	The switch port number of the logical port
• DoS Protection	Displays the current DoS protection

### 4.9.12 Storm Control

Storm control for the switch is configured on this page.

There is an unknown unicast storm rate control, unknown multicast storm rate control, and a broadcast storm rate control.

These only affect flooded frames, i.e. frames with a (VLAN ID, DMAC) pair not present on the MAC Address table.

#### 4.9.12.1 Global Setting

The Storm Control Global Setting and Information screens in [Figure 4-9-69](#) & [Figure 4-9-70](#) appear.

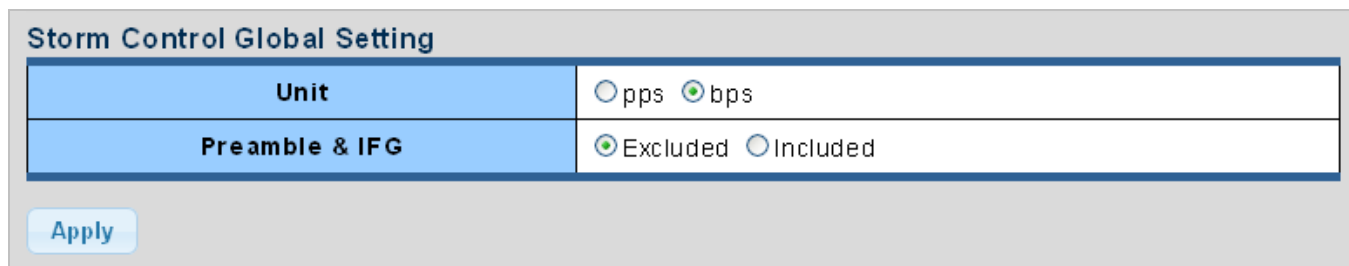

Figure 4-9-69 Storm Control Global Setting Page Screenshot

The page includes the following fields:

Object	Description
<ul style="list-style-type: none"> <li>Unit</li> </ul>	Controls the unit of measure for the storm control rate as "pps" or "bps". The default value is "bps".
<ul style="list-style-type: none"> <li>Preamble &amp; IFG</li> </ul>	Set the excluded or included interframe gap

#### Buttons

: Click to apply changes.

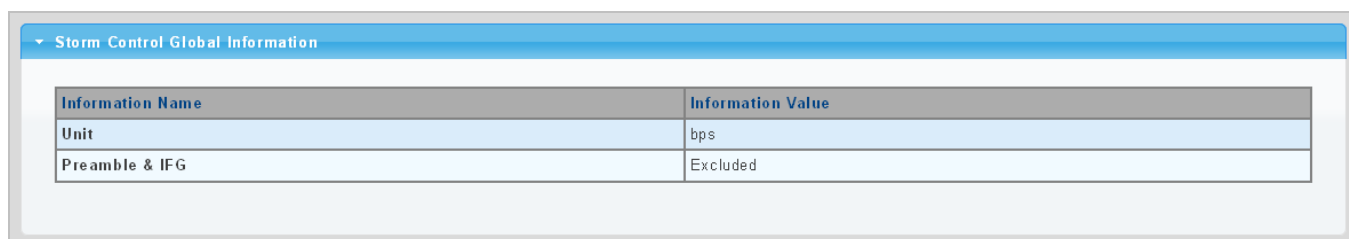

Figure 4-9-70 Storm Control Global Information Page Screenshot

The page includes the following fields:

Object	Description
<ul style="list-style-type: none"> <li>Unit</li> </ul>	Displays the current unit
<ul style="list-style-type: none"> <li>Preamble &amp; IFG</li> </ul>	Displays the current preamble & IFG

### 4.9.12.2 Port Setting

Storm control for the switch is configured on this page. There are three types of storm rate control:

- **Broadcast** storm rate control
- **Unknown Unicast** storm rate control
- **Unknown Multicast** storm rate control

The configuration indicates the permitted packet rate for unknown unicast, unknown multicast, or broadcast traffic across the switch. The Storm Control Configuration screens in [Figure 4-9-71](#) & [Figure 4-9-72](#) appear.

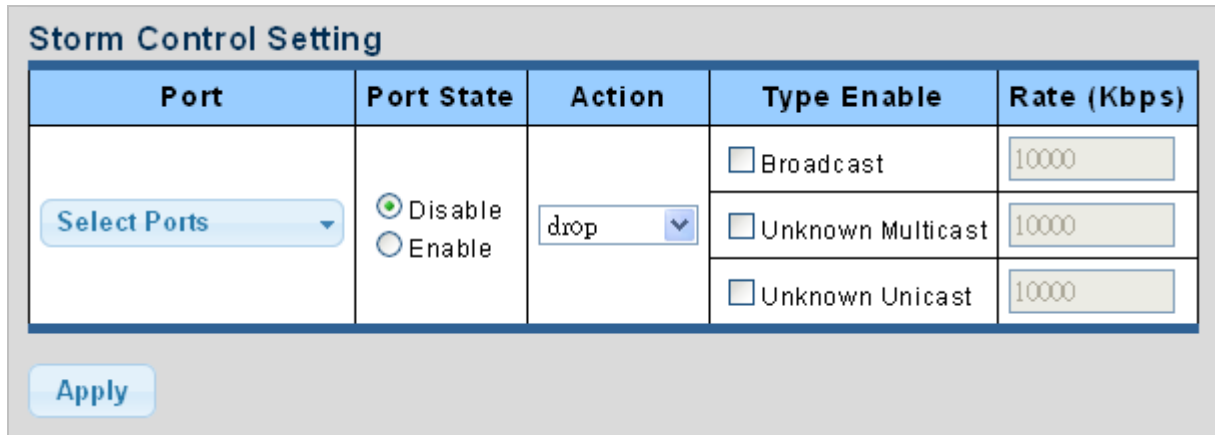

Port	Port State	Action	Type Enable	Rate (Kbps)
Select Ports	<input checked="" type="radio"/> Disable <input type="radio"/> Enable	drop	<input type="checkbox"/> Broadcast	10000
			<input type="checkbox"/> Unknown Multicast	10000
			<input type="checkbox"/> Unknown Unicast	10000

Apply

Figure 4-9-71 Storm Control Setting Page Screenshot

The page includes the following fields:

Object	Description
• <b>Port</b>	Select port from this drop-down list.
• <b>Port State</b>	Enable or disable the storm control status for the given storm type.
• <b>Action</b>	Configures the action performed when storm control is over rate on a port. Valid values are <b>Shutdown</b> or <b>Drop</b> .
• <b>Type Enable</b>	The settings in a particular row apply to the frame type listed here: <ul style="list-style-type: none"> <li>■ <b>broadcast</b></li> <li>■ <b>unknown unicast</b></li> <li>■ <b>unknown multicast</b></li> </ul>
• <b>Rate (kbps/pps)</b>	Configures the rate for the storm control. The default value is "10,000".

#### Buttons

: Click to apply changes

Storm Control Information					
Port	Port State	Broadcast (Kbps)	Unknown Multicast (Kbps)	Unknown Unicast (Kbps)	Action
GE1	disabled	Off (10000)	Off (10000)	Off (10000)	Drop
GE2	disabled	Off (10000)	Off (10000)	Off (10000)	Drop
GE3	disabled	Off (10000)	Off (10000)	Off (10000)	Drop
GE4	disabled	Off (10000)	Off (10000)	Off (10000)	Drop
GE5	disabled	Off (10000)	Off (10000)	Off (10000)	Drop
GE6	disabled	Off (10000)	Off (10000)	Off (10000)	Drop
GE7	disabled	Off (10000)	Off (10000)	Off (10000)	Drop
GE8	disabled	Off (10000)	Off (10000)	Off (10000)	Drop
GE9	disabled	Off (10000)	Off (10000)	Off (10000)	Drop
GE10	disabled	Off (10000)	Off (10000)	Off (10000)	Drop

Figure 4-9-72 Storm Control Information Page Screenshot

The page includes the following fields:

Object	Description
• Port	The switch port number of the logical port
• Port State	Displays the current port state
• Broadcast (Kbps/pps)	Displays the current broadcast storm control rate
• Unknown Multicast (Kbps/pps)	Displays the current unknown multicast storm control rate
• Unknown Unicast (Kbps/pps)	Displays the current unknown unicast storm control rate
• Action	Displays the current action

## 4.10 ACL

**ACL** is an acronym for **Access Control List**. It is the list table of ACEs, containing access control entries that specify individual users or groups permitted or denied to specific traffic objects, such as a process or a program. Each accessible traffic object contains an identifier to its ACL. The privileges determine whether there are specific traffic object access rights.

ACL implementations can be quite complex, for example, when the ACEs are prioritized for the various situation. In networking, the ACL refers to a list of service ports or network services that are available on a host or server, each with a list of hosts or servers permitted or denied to use the service. ACL can generally be configured to control inbound traffic, and in this context, they are similar to firewalls.

**ACE** is an acronym for **Access Control Entry**. It describes access permission associated with a particular ACE ID. There are three ACE frame types (Ethernet Type, ARP, and IPv4) and two ACE actions (permit and deny). The ACE also contains many detailed, different parameter options that are available for individual application.

The ACL page contains links to the following main topics:

- **MAC-based ACL** Configuration MAC-based ACL setting
- **MAC-based ACE** Add / Edit / Delete the MAC-based ACE (Access Control Entry) setting
- **IPv4-based ACL** Configuration IPv4-based ACL setting
- **IPv4-based ACE** Add / Edit / Delete the IPv4-based ACE (Access Control Entry) setting
- **IPv6-based ACL** Configuration IPv6-based ACL setting
- **IPv6-based ACE** Add / Edit / Delete the IPv6-based ACE (Access Control Entry) setting
- **ACL Binding** Configure the ACL parameters (ACE) of each switch port.

### 4.10.1 MAC-based ACL

This page shows the ACL status by different ACL users. Each row describes the ACE that is defined. It is a conflict if a specific ACE is not applied to the hardware due to hardware limitations. MAC-based ACL screens in [Figure 4-10-1](#) & [Figure 4-10-2](#) appear.



Figure 4-10-1 MAC-based ACL Page Screenshot

The page includes the following fields:

Object	Description
• ACL Name	Create a named MAC-based ACL list

#### ■ ACL Table

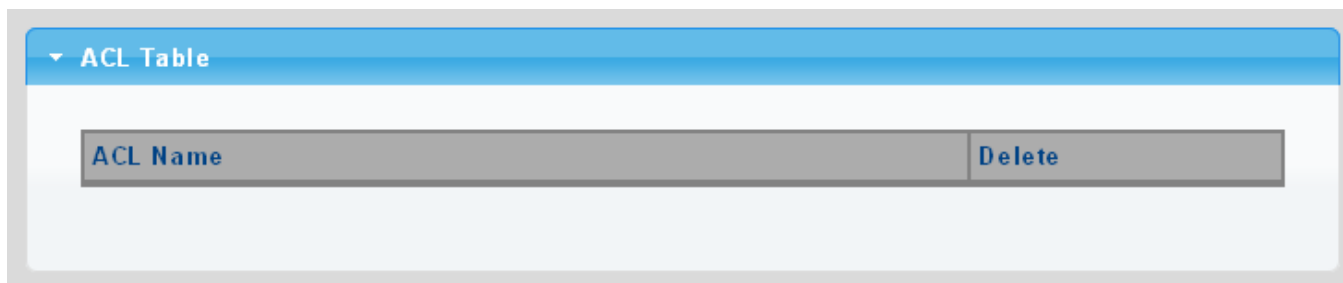



Figure 4-10-2 ACL Table Page Screenshot

The page includes the following fields:

Object	Description
• Delete	Click  to delete ACL name entry

### 4.10.2 MAC-based ACE

An ACE consists of several parameters. Different parameter options are displayed depending on the frame type that you selected. The MAC-based ACE screen in [Figure 4-10-3](#) & [Figure 4-10-4](#) appears.

**MAC-Based ACE**

<b>ACL Name</b>	<input type="text" value=""/>
<b>Sequence</b>	<input type="text" value=""/> (Range: 1 - 2147483647, 1 is first processed)
<b>Action</b>	<input checked="" type="radio"/> Permit <input type="radio"/> Deny <input type="radio"/> Shutdown
<b>DA MAC</b>	<input checked="" type="radio"/> Any <input type="radio"/> User Defined
<b>DA MAC Value</b>	<input type="text" value=""/>
<b>DA MAC Mask</b>	<input type="text" value=""/> (0s for matching, 1s for no matching)
<b>SA MAC</b>	<input checked="" type="radio"/> Any <input type="radio"/> User Defined
<b>SA MAC Value</b>	<input type="text" value=""/>
<b>SA MAC Mask</b>	<input type="text" value=""/> (0s for matching, 1s for no matching)
<b>VLAN ID</b>	<input type="text" value=""/> (Range: 1 - 4094)
<b>802.1p</b>	<input type="checkbox"/> Include
<b>802.1p Value</b>	<input type="text" value=""/> (Range: 0-7)
<b>802.1p Mask</b>	<input type="text" value=""/>
<b>Ethertype (Range: 0x05DD-0xFFFF)</b>	<input type="text" value=""/> (Range: 0x05DD-0xFFFF)

Figure 4-10-3 MAC-based ACE Page Screenshot

The page includes the following fields:

Object	Description
• <b>ACL Name</b>	Select ACL name for this drop down list
• <b>Sequence</b>	Set the ACL sequence
• <b>Action</b>	Indicates the forwarding action of the ACE. <ul style="list-style-type: none"> <li>■ <b>Permit</b>: Frames matching the ACE may be forwarded and learned.</li> <li>■ <b>Deny</b>: Frames matching the ACE are dropped.</li> <li>■ <b>Shutdown</b>: Port shutdown is disabled for the ACE.</li> </ul>
• <b>DA MAC</b>	Specify the destination MAC filter for this ACE. <ul style="list-style-type: none"> <li>■ <b>Any</b>: No DA MAC filter is specified.</li> <li>■ <b>User Defined</b>: If you want to filter a specific destination MAC address with</li> </ul>

	this ACE, choose this value. A field for entering a DA MAC value appears.
• <b>DA MAC Value</b>	When "User Defined" is selected for the DA MAC filter, you can enter a specific destination MAC address. The legal format is "xx-xx-xx-xx-xx-xx". A frame that hits this ACE matches this DA MAC value.
• <b>DA MAC Mask</b>	Specify whether frames can hit the action according to their sender hardware address field (SHA) settings. <ul style="list-style-type: none"> <li>■ <b>0</b>: ARP frames where SHA is not equal to the DA MAC address.</li> <li>■ <b>1</b>: ARP frames where SHA is equal to the DA MAC address.</li> </ul>
• <b>SA MAC</b>	Specify the source MAC filter for this ACE. <ul style="list-style-type: none"> <li>■ <b>Any</b>: No SA MAC filter is specified.</li> <li>■ <b>User Defined</b>: If you want to filter a specific source MAC address with this ACE, choose this value. A field for entering a SA MAC value appears.</li> </ul>
• <b>SA MAC Value</b>	When "User Defined" is selected for the SA MAC filter, you can enter a specific source MAC address. The legal format is "xx-xx-xx-xx-xx-xx". A frame that hits this ACE matches this SA MAC value.
• <b>SA MAC Mask</b>	Specify whether frames can hit the action according to their sender hardware address field (SHA) settings. <ul style="list-style-type: none"> <li>■ <b>0</b>: ARP frames where SHA is not equal to the SA MAC address.</li> <li>■ <b>1</b>: ARP frames where SHA is equal to the SA MAC address.</li> </ul>
• <b>VLAN ID</b>	Indicates the ID of this particular VLAN
• <b>802.1p</b>	Include or exclude the 802.1p value
• <b>802.1p Value</b>	Set the 802.1p value
• <b>802.1p Mask</b>	<ul style="list-style-type: none"> <li>■ <b>0</b>: where frame is not equal to the 802.1p value.</li> <li>■ <b>1</b>: where frame is equal to the 802.1p value.</li> </ul>
• <b>Ethertype</b> (Range:0x05DD – 0xFFFF)	You can enter a specific EtherType value. The allowed range is <b>0x05DD</b> to <b>0xFFFF</b> . A frame that hits this ACE matches this EtherType value.

**Buttons**

 : Click to add ACE list.

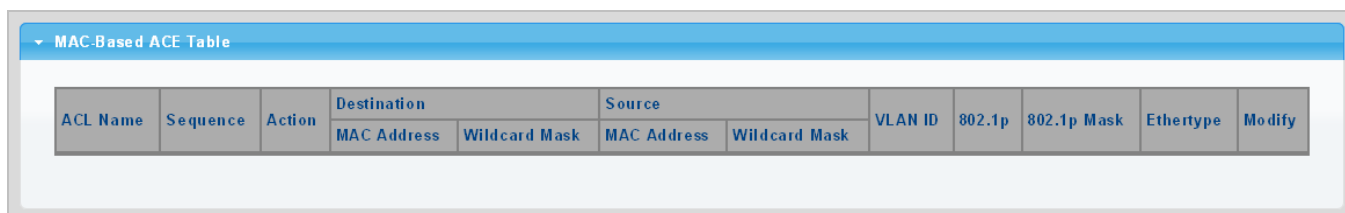



ACL Name	Sequence	Action	Destination		Source		VLAN ID	802.1p	802.1p Mask	EtherType	Modify
			MAC Address	Wildcard Mask	MAC Address	Wildcard Mask					

Figure 4-10-4 MAC-based ACE Table Page Screenshot



The page includes the following fields:

Object	Description
• <b>ACL Name</b>	Displays the current ACL name
• <b>Sequence</b>	Displays the current sequence
• <b>Action</b>	Displays the current action
• <b>Destination MAC Address</b>	Displays the current destination MAC address
• <b>Destination MAC Address Mask</b>	Displays the current destination MAC address mask
• <b>Source MAC Address</b>	Displays the current source MAC address
• <b>Source MAC Address Mask</b>	Displays the current source MAC address mask
• <b>VLAN ID</b>	Displays the current VLAN ID
• <b>802.1p</b>	Displays the current 802.1p value
• <b>802.1p Mask</b>	Displays the current 802.1p mask
• <b>Ethertype</b>	Displays the current Ethernet type
• <b>Modify</b>	<p>Click  to edit MAC-based ACL parameter</p> <p>Click  to delete MAC-based ACL entry</p>

### 4.10.3 IPv4-based ACL

This page shows the ACL status by different ACL users. Each row describes the ACE that is defined. It is a conflict if a specific ACE is not applied to the hardware due to hardware limitations. IPv4-based ACL screens in [Figure 4-10-5](#) & [Figure 4-10-6](#) appear.



Figure 4-10-5 IPv4-based ACL Page Screenshot

The page includes the following fields:

Object	Description
• ACL Name	Create a named IPv4-based ACL list

#### Buttons

: Click to add ACL name list.

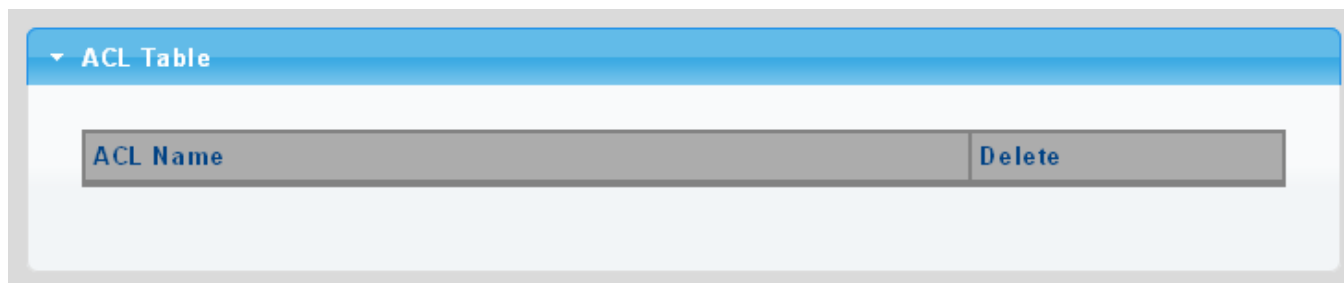



Figure 4-10-6 ACL Table Page Screenshot

The page includes the following fields:

Object	Description
• Delete	Click  to delete ACL name entry.

### 4.10.4 IPv4-based ACE

An ACE consists of several parameters. Different parameter options are displayed depending on the frame type that you selected. The IPv4-based ACE screens in [Figure 4-10-7](#) & [Figure 4-10-8](#) appear.

IPv4-Based ACE	
<b>ACL Name</b>	<input type="text" value=""/>
<b>Sequence</b>	<input type="text" value=""/> (Range: 1 - 2147483647, 1 is first processed)
<b>Action</b>	<input checked="" type="radio"/> Permit <input type="radio"/> Deny <input type="radio"/> Shutdown
<b>Protocol</b>	<input checked="" type="radio"/> Any(IP) <input type="radio"/> Select from list <input type="text" value="icmp"/> <input type="button" value="v"/> <input type="radio"/> Protocol ID to match <input type="text" value="1"/>
<b>Source IP Address</b>	<input checked="" type="radio"/> Any <input type="radio"/> User Defined
<b>Source IP Address Value</b>	<input type="text" value=""/>
<b>Source IP Wildcard Mask</b>	<input type="text" value=""/> (0s for matching, 1s for no matching)
<b>Destination IP Address</b>	<input checked="" type="radio"/> Any <input type="radio"/> User Defined
<b>Destination IP Address Value</b>	<input type="text" value=""/>
<b>Destination IP Wildcard Mask</b>	<input type="text" value=""/> (0s for matching, 1s for no matching)
<b>Source Port</b>	<input checked="" type="radio"/> Any <input type="radio"/> Single <input type="text" value="0"/> (Range: 0 - 65535) <input type="radio"/> Range <input type="text" value="0"/> - <input type="text" value="65535"/> (Range: 0 - 65535)
<b>Destination Port</b>	<input checked="" type="radio"/> Any <input type="radio"/> Single(Range: 0 - 65535) <input type="text" value="0"/> (Range: 0 - 65535) <input type="radio"/> Range(Range: 0 - 65535) <input type="text" value="0"/> - <input type="text" value="65535"/> (Range: 0 - 65535)
<b>TCP Flags</b>	Urg <input checked="" type="radio"/> Set <input type="radio"/> Unset <input type="radio"/> Don't Care Ack <input checked="" type="radio"/> Set <input type="radio"/> Unset <input type="radio"/> Don't Care Psh <input checked="" type="radio"/> Set <input type="radio"/> Unset <input type="radio"/> Don't Care Rst <input checked="" type="radio"/> Set <input type="radio"/> Unset <input type="radio"/> Don't Care Syn <input checked="" type="radio"/> Set <input type="radio"/> Unset <input type="radio"/> Don't Care Fin <input checked="" type="radio"/> Set <input type="radio"/> Unset <input type="radio"/> Don't Care
<b>Type of Service</b>	<input checked="" type="radio"/> Any <input type="radio"/> DSCP to match <input type="text" value="0"/> (Range: 0 - 63) <input type="radio"/> IP Precedence to match <input type="text" value="0"/> (Range: 0 - 7)
<b>ICMP</b>	<input checked="" type="radio"/> Any <input type="radio"/> Select from list <input type="text" value="Echo Reply"/> <input type="button" value="v"/> <input type="radio"/> Protocol ID to match <input type="text" value="0"/> (Range: 0 - 255)
<b>ICMP Code</b>	<input checked="" type="radio"/> Any <input type="radio"/> User Defined <input type="text" value="0"/> (Range: 0 - 255)

Figure 4-10-7 IP-based ACE Page Screenshot

The page includes the following fields:

Object	Description
• <b>ACL Name</b>	Select ACL name from this drop-down list.
• <b>Sequence</b>	Set the ACL sequence.
• <b>Action</b>	Indicates the forwarding action of the ACE. <ul style="list-style-type: none"> <li>■ <b>Permit</b>: Frames matching the ACE may be forwarded and learned.</li> <li>■ <b>Deny</b>: Frames matching the ACE are dropped.</li> <li>■ <b>Shutdown</b>: Port shutdown is disabled for the ACE..</li> </ul>
• <b>Protocol</b>	Specify the protocol filter for this ACE. <ul style="list-style-type: none"> <li>■ <b>Any(IP)</b>: No protocol filter is specified.</li> <li>■ <b>Select from list</b>: If you want to filter a specific protocol with this ACE, choose this value and select protocol for this drop down list.</li> <li>■ <b>Protocol ID to match</b>: If you want to filter a specific protocol with this ACE, choose this value and set current protocol ID.</li> </ul>
• <b>Source IP Address</b>	Specify the Source IP address filter for this ACE. <ul style="list-style-type: none"> <li>■ <b>Any</b>: No source IP address filter is specified.</li> <li>■ <b>User Defined</b>: If you want to filter a specific source IP address with this ACE, choose this value. A field for entering a source IP address value appears.</li> </ul>
• <b>Source IP Address Value</b>	When "User Defined" is selected for the source IP address filter, you can enter a specific source IP address. The legal format is "xxx.xxx.xxx.xxx". A frame that hits this ACE matches this source IP address value.
• <b>Source IP Wildcard Mask</b>	When "User Defined" is selected for the source IP filter, you can enter a specific SIP mask in dotted decimal notation.
• <b>Destination IP Address</b>	Specify the Destination IP address filter for this ACE. <ul style="list-style-type: none"> <li>■ <b>Any</b>: No destination IP address filter is specified.</li> <li>■ <b>User Defined</b>: If you want to filter a specific destination IP address with this ACE, choose this value. A field for entering a source IP address value appears.</li> </ul>
• <b>Destination IP Address Value</b>	When "User Defined" is selected for the destination IP address filter, you can enter a specific destination IP address. The legal format is "xxx.xxx.xxx.xxx". A frame that hits this ACE matches this destination IP address value.
• <b>Destination IP Wildcard Mask</b>	When "User Defined" is selected for the destination IP filter, you can enter a specific DIP mask in dotted decimal notation.
• <b>Source Port</b>	Specify the source port for this ACE. <ul style="list-style-type: none"> <li>■ <b>Any</b>: No specific source port is specified (source port status is "don't-care").</li> <li>■ <b>Single</b>: If you want to filter a specific source port with this ACE, you can enter a specific source port value. A field for entering a source port value appears. The allowed range is 0 to 65535. A frame that hits this ACE matches this source port value.</li> </ul>

	<ul style="list-style-type: none"> <li>■ <b>Range:</b> If you want to filter a specific source port range filter with this ACE, you can enter a specific source port range value. A field for entering a source port value appears. The allowed range is 0 to 65535. A frame that hits this ACE matches this source port value.</li> </ul>								
<ul style="list-style-type: none"> <li>• <b>Destination Port</b></li> </ul>	<p>Specify the destination port for this ACE.</p> <ul style="list-style-type: none"> <li>■ <b>Any:</b> No specific destination port is specified (destination port status is "don't-care").</li> <li>■ <b>Single:</b> If you want to filter a specific destination port with this ACE, you can enter a specific destination port value. A field for entering a destination port value appears. The allowed range is 0 to 65535. A frame that hits this ACE matches this destination port value.</li> <li>■ <b>Range:</b> If you want to filter a specific destination port range filter with this ACE, you can enter a specific destination port range value. A field for entering a destination port value appears.</li> </ul>								
<ul style="list-style-type: none"> <li>• <b>TCP Flags</b></li> </ul>	<table border="1"> <tr> <td data-bbox="523 826 625 1167">UGR</td> <td data-bbox="625 826 1404 1167"> <p>Specify the TCP "Urgent Pointer field significant" (URG) value for this ACE.</p> <ul style="list-style-type: none"> <li>■ <b>Set:</b> TCP frames where the URG field is set must be able to match this entry.</li> <li>■ <b>Unset:</b> TCP frames where the URG field is set must not be able to match this entry.</li> <li>■ <b>Don't Care:</b> Any value is allowed ("don't-care").</li> </ul> </td> </tr> <tr> <td data-bbox="523 1167 625 1507">ACK</td> <td data-bbox="625 1167 1404 1507"> <p>Specify the TCP "Acknowledgment field significant" (ACK) value for this ACE.</p> <ul style="list-style-type: none"> <li>■ <b>Set:</b> TCP frames where the ACK field is set must be able to match this entry.</li> <li>■ <b>Unset:</b> TCP frames where the ACK field is set must not be able to match this entry.</li> <li>■ <b>Don't Care:</b> Any value is allowed ("don't-care").</li> </ul> </td> </tr> <tr> <td data-bbox="523 1507 625 1794">PSH</td> <td data-bbox="625 1507 1404 1794"> <p>Specify the TCP "Push Function" (PSH) value for this ACE.</p> <ul style="list-style-type: none"> <li>■ <b>Set:</b> TCP frames where the PSH field is set must be able to match this entry.</li> <li>■ <b>Unset:</b> TCP frames where the PSH field is set must not be able to match this entry.</li> <li>■ <b>Don't Care:</b> Any value is allowed ("don't-care").</li> </ul> </td> </tr> <tr> <td data-bbox="523 1794 625 2078">RST</td> <td data-bbox="625 1794 1404 2078"> <ul style="list-style-type: none"> <li>■ Specify the TCP "Reset the connection" (RST) value for this ACE. <ul style="list-style-type: none"> <li>■ <b>Set:</b> TCP frames where the RST field is set must be able to match this entry.</li> <li>■ <b>Unset:</b> TCP frames where the RST field is set must not be able to match this entry.</li> <li>■ <b>Don't Care:</b> Any value is allowed ("don't-care").</li> </ul> </li> </ul> </td> </tr> </table>	UGR	<p>Specify the TCP "Urgent Pointer field significant" (URG) value for this ACE.</p> <ul style="list-style-type: none"> <li>■ <b>Set:</b> TCP frames where the URG field is set must be able to match this entry.</li> <li>■ <b>Unset:</b> TCP frames where the URG field is set must not be able to match this entry.</li> <li>■ <b>Don't Care:</b> Any value is allowed ("don't-care").</li> </ul>	ACK	<p>Specify the TCP "Acknowledgment field significant" (ACK) value for this ACE.</p> <ul style="list-style-type: none"> <li>■ <b>Set:</b> TCP frames where the ACK field is set must be able to match this entry.</li> <li>■ <b>Unset:</b> TCP frames where the ACK field is set must not be able to match this entry.</li> <li>■ <b>Don't Care:</b> Any value is allowed ("don't-care").</li> </ul>	PSH	<p>Specify the TCP "Push Function" (PSH) value for this ACE.</p> <ul style="list-style-type: none"> <li>■ <b>Set:</b> TCP frames where the PSH field is set must be able to match this entry.</li> <li>■ <b>Unset:</b> TCP frames where the PSH field is set must not be able to match this entry.</li> <li>■ <b>Don't Care:</b> Any value is allowed ("don't-care").</li> </ul>	RST	<ul style="list-style-type: none"> <li>■ Specify the TCP "Reset the connection" (RST) value for this ACE. <ul style="list-style-type: none"> <li>■ <b>Set:</b> TCP frames where the RST field is set must be able to match this entry.</li> <li>■ <b>Unset:</b> TCP frames where the RST field is set must not be able to match this entry.</li> <li>■ <b>Don't Care:</b> Any value is allowed ("don't-care").</li> </ul> </li> </ul>
UGR	<p>Specify the TCP "Urgent Pointer field significant" (URG) value for this ACE.</p> <ul style="list-style-type: none"> <li>■ <b>Set:</b> TCP frames where the URG field is set must be able to match this entry.</li> <li>■ <b>Unset:</b> TCP frames where the URG field is set must not be able to match this entry.</li> <li>■ <b>Don't Care:</b> Any value is allowed ("don't-care").</li> </ul>								
ACK	<p>Specify the TCP "Acknowledgment field significant" (ACK) value for this ACE.</p> <ul style="list-style-type: none"> <li>■ <b>Set:</b> TCP frames where the ACK field is set must be able to match this entry.</li> <li>■ <b>Unset:</b> TCP frames where the ACK field is set must not be able to match this entry.</li> <li>■ <b>Don't Care:</b> Any value is allowed ("don't-care").</li> </ul>								
PSH	<p>Specify the TCP "Push Function" (PSH) value for this ACE.</p> <ul style="list-style-type: none"> <li>■ <b>Set:</b> TCP frames where the PSH field is set must be able to match this entry.</li> <li>■ <b>Unset:</b> TCP frames where the PSH field is set must not be able to match this entry.</li> <li>■ <b>Don't Care:</b> Any value is allowed ("don't-care").</li> </ul>								
RST	<ul style="list-style-type: none"> <li>■ Specify the TCP "Reset the connection" (RST) value for this ACE. <ul style="list-style-type: none"> <li>■ <b>Set:</b> TCP frames where the RST field is set must be able to match this entry.</li> <li>■ <b>Unset:</b> TCP frames where the RST field is set must not be able to match this entry.</li> <li>■ <b>Don't Care:</b> Any value is allowed ("don't-care").</li> </ul> </li> </ul>								

	SYN	<p>Specify the TCP "Synchronize sequence numbers" (SYN) value for this ACE.</p> <ul style="list-style-type: none"> <li>■ <b>Set:</b> TCP frames where the SYN field is set must be able to match this entry.</li> <li>■ <b>Unset:</b> TCP frames where the SYN field is set must not be able to match this entry.</li> <li>■ <b>Don't Care:</b> Any value is allowed ("don't-care").</li> </ul>
	FIN	<p>Specify the TCP "No more data from sender" (FIN) value for this ACE.</p> <ul style="list-style-type: none"> <li>■ <b>Set:</b> TCP frames where the FIN field is set must be able to match this entry.</li> <li>■ <b>Unset:</b> TCP frames where the FIN field is set must not be able to match this entry.</li> <li>■ <b>Don't Care:</b> Any value is allowed ("don't-care").</li> </ul>
<ul style="list-style-type: none"> <li>• <b>Type of Service</b></li> </ul>		<p>Specify the type of service for this ACE.</p> <ul style="list-style-type: none"> <li>■ <b>Any:</b> No specific type of service is specified (destination port status is "don't-care").</li> <li>■ <b>DSCP:</b> If you want to filter a specific DSCP with this ACE, you can enter a specific DSCP value. A field for entering a DSCP value appears. The allowed range is 0 to 63. A frame that hits this ACE matches this DSCP value.</li> <li>■ <b>IP Precedence:</b> If you want to filter a specific IP precedence with this ACE, you can enter a specific IP precedence value. A field for entering an IP precedence value appears. The allowed range is 0 to 7. A frame that hits this ACE matches this IP precedence value.</li> </ul>
<ul style="list-style-type: none"> <li>• <b>ICMP</b></li> </ul>		<p>Specify the ICMP for this ACE.</p> <ul style="list-style-type: none"> <li>■ <b>Any:</b> No specific ICMP is specified (destination port status is "don't-care").</li> <li>■ <b>List:</b> If you want to filter a specific list with this ACE, you can select a specific list value.</li> <li>■ <b>Protocol ID:</b> If you want to filter a specific protocol ID filter with this ACE, you can enter a specific protocol ID value. A field for entering a protocol ID value appears. The allowed range is 0 to 255. A frame that hits this ACE matches this protocol ID value.</li> </ul>
<ul style="list-style-type: none"> <li>• <b>ICMP Code</b></li> </ul>		<p>Specify the ICMP code filter for this ACE.</p> <ul style="list-style-type: none"> <li>■ <b>Any:</b> No ICMP code filter is specified (ICMP code filter status is "don't-care").</li> <li>■ <b>User Defined:</b> If you want to filter a specific ICMP code filter with this ACE, you can enter a specific ICMP code value. A field for entering an ICMP code value appears. The allowed range is 0 to 255. A frame that hits this ACE matches this ICMP code value.</li> </ul>

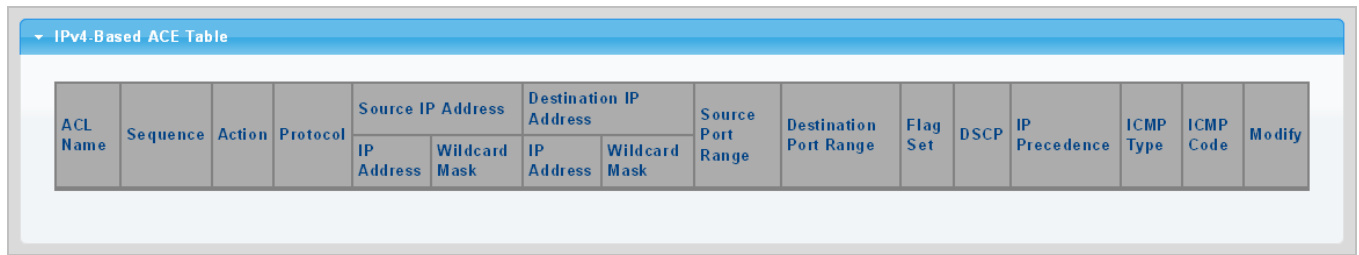

**Buttons**

: Click to add ACE list.



**Figure 4-10-8** IPv4-based ACE Table Page Screenshot

The page includes the following fields:

Object	Description
• <b>ACL Name</b>	Displays the current ACL name
• <b>Sequence</b>	Displays the current sequence
• <b>Action</b>	Displays the current action
• <b>Protocol</b>	Displays the current protocol
• <b>Source IP Address</b>	Displays the current source IP address
• <b>Source IP Address Wildcard Mask</b>	Displays the current source IP address wildcard mask
• <b>Destination IP Address</b>	Displays the current destination IP address
• <b>Destination IP Address Wildcard Mask</b>	Displays the current destination IP address wildcard mask
• <b>Source Port Range</b>	Displays the current source port range
• <b>Destination Port Range</b>	Displays the current destination port range
• <b>Flag Set</b>	Displays the current flag set
• <b>DSCP</b>	Displays the current DSCP
• <b>IP Precedence</b>	Displays the current IP precedence
• <b>ICMP Type</b>	Displays the current ICMP Type
• <b>ICMP Code</b>	Displays the current ICMP code
• <b>Modify</b>	<p>Click  to edit IPv4-based ACL parameter</p> <p>Click  to delete IPv4-based ACL entry</p>

### 4.10.5 IPv6-based ACL

This page shows the ACL status by different ACL users. Each row describes the ACE that is defined. It is a conflict if a specific ACE is not applied to the hardware due to hardware limitations. IPv6-based ACL screens in [Figure 4-10-9](#) & [Figure 4-10-10](#) appear.



Figure 4-10-9 IPv6-based ACL Page Screenshot

The page includes the following fields:

Object	Description
<ul style="list-style-type: none"> <li>• <b>ACL Name</b></li> </ul>	Create a named IPv6-based ACL list

#### Buttons



: Click to add ACL name list.

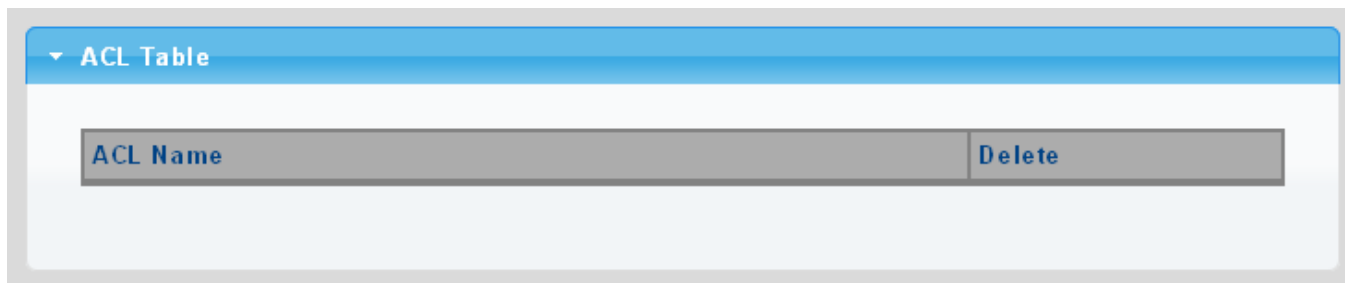



Figure 4-10-10 ACL Table Page Screenshot

The page includes the following fields:

Object	Description
<ul style="list-style-type: none"> <li>• <b>Delete</b></li> </ul>	Click  to delete ACL name entry



### 4.10.6 IPv6-based ACE

An ACE consists of several parameters. Different parameter options are displayed depending on the frame type that you selected. The IPv6-based ACE screens in [Figure 4-10-11](#) & [Figure 4-10-12](#) appear.

IPv6-Based ACE	
<b>ACL Name</b>	<input type="text" value=""/> <span>▼</span>
<b>Sequence</b>	<input type="text" value=""/> (Range: 1 - 2147483647, 1 is first processed)
<b>Action</b>	<input checked="" type="radio"/> Permit <input type="radio"/> Deny <input type="radio"/> Shutdown
<b>Protocol</b>	<input checked="" type="radio"/> Any(IP) <input type="radio"/> Select from list <input type="text" value="tcp"/> <span>▼</span>
<b>Source IP Address</b>	<input checked="" type="radio"/> Any <input type="radio"/> User Defined
<b>Source IP Address Value</b>	<input type="text" value=""/>
<b>Source IP Prefix Length</b>	<input type="text" value="0"/> (Range: 0 - 128)
<b>Destination IP Address</b>	<input checked="" type="radio"/> Any <input type="radio"/> User Defined
<b>Destination IP Address Value</b>	<input type="text" value=""/>
<b>Destination IP Prefix Length</b>	<input type="text" value="0"/> (0s for matching, 1s for no matching)
<b>Source Port</b>	<input checked="" type="radio"/> Any <input type="radio"/> Single <input type="text" value="0"/> (Range: 0 - 65535) <input type="radio"/> Range <input type="text" value="0"/> - <input type="text" value="65535"/> (Range: 0 - 65535)
<b>Destination Port</b>	<input checked="" type="radio"/> Any <input type="radio"/> Single(Range: 0 - 65535) <input type="text" value="0"/> (Range: 0 - 65535) <input type="radio"/> Range(Range: 0 - 65535) <input type="text" value="0"/> - <input type="text" value="65535"/> (Range: 0 - 65535)
<b>TCP Flags</b>	Urg <input checked="" type="radio"/> Set <input type="radio"/> Unset <input type="radio"/> Don't Care Ack <input checked="" type="radio"/> Set <input type="radio"/> Unset <input type="radio"/> Don't Care Psh <input checked="" type="radio"/> Set <input type="radio"/> Unset <input type="radio"/> Don't Care Rst <input checked="" type="radio"/> Set <input type="radio"/> Unset <input type="radio"/> Don't Care Syn <input checked="" type="radio"/> Set <input type="radio"/> Unset <input type="radio"/> Don't Care Fin <input checked="" type="radio"/> Set <input type="radio"/> Unset <input type="radio"/> Don't Care
<b>Type of Service</b>	<input checked="" type="radio"/> Any <input type="radio"/> DSCP to match <input type="text" value="0"/> (Range: 0 - 63) <input type="radio"/> IP Precedence to match <input type="text" value="0"/> (Range: 0 - 7)
<b>ICMP</b>	<input checked="" type="radio"/> Any <input type="radio"/> Select from list <input type="text" value="destination"/> <span>▼</span> <input type="radio"/> Protocol ID to match <input type="text" value="0"/> (Range: 0 - 255)
<b>ICMP Code</b>	<input checked="" type="radio"/> Any <input type="radio"/> User Defined <input type="text" value="0"/> (Range: 0 - 255)

Figure 4-10-11 IP-based ACE Page Screenshot

The page includes the following fields:

Object	Description
• <b>ACL Name</b>	Select ACL name from this drop-down list
• <b>Sequence</b>	Set the ACL sequence
• <b>Action</b>	Indicates the forwarding action of the ACE <ul style="list-style-type: none"> <li>■ <b>Permit</b>: Frames matching the ACE may be forwarded and learned.</li> <li>■ <b>Deny</b>: Frames matching the ACE are dropped.</li> <li>■ <b>Shutdown</b>: Port shutdown is disabled for the ACE.</li> </ul>
• <b>Protocol</b>	Specify the protocol filter for this ACE <ul style="list-style-type: none"> <li>■ <b>Any (IP)</b>: No protocol filter is specified.</li> <li>■ <b>Select from list</b>: If you want to filter a specific protocol with this ACE, choose this value and select protocol for this drop down list.</li> </ul>
• <b>Source IP Address</b>	Specify the Source IP address filter for this ACE <ul style="list-style-type: none"> <li>■ <b>Any</b>: No source IP address filter is specified.</li> <li>■ <b>User Defined</b>: If you want to filter a specific source IP address with this ACE, choose this value. A field for entering a source IP address value appears.</li> </ul>
• <b>Source IP Address Value</b>	When "User Defined" is selected for the source IP address filter, you can enter a specific source IP address. The legal format is "xxxx:xxxx:xxxx:xxxx:xxxx:xxxx:xxxx:xxxx". A frame that hits this ACE matches this source IP address value.
• <b>Source IP Prefix Length</b>	When "User Defined" is selected for the source IP filter, you can enter a specific SIP prefix length in dotted decimal notation.
• <b>Destination IP Address</b>	Specify the Destination IP address filter for this ACE. <ul style="list-style-type: none"> <li>■ <b>Any</b>: No destination IP address filter is specified.</li> <li>■ <b>User Defined</b>: If you want to filter a specific destination IP address with this ACE, choose this value. A field for entering a source IP address value appears.</li> </ul>
• <b>Destination IP Address Value</b>	When "User Defined" is selected for the destination IP address filter, you can enter a specific destination IP address. The legal format is " xxxx:xxxx:xxxx:xxxx:xxxx:xxxx:xxxx:xxxx ". A frame that hits this ACE matches this destination IP address value.
• <b>Destination IP Prefix Length</b>	When "User Defined" is selected for the destination IP filter, you can enter a specific DIP prefix length in dotted decimal notation.
• <b>Source Port</b>	Specify the source port for this ACE. <ul style="list-style-type: none"> <li>■ <b>Any</b>: No specific source port is specified (source port status is "don't-care").</li> <li>■ <b>Single</b>: If you want to filter a specific source port with this ACE, you can enter a specific source port value. A field for entering a source port value appears. The allowed range is 0 to 65535. A frame that hits this ACE matches this source port value.</li> </ul>

	<ul style="list-style-type: none"> <li>■ <b>Range:</b> If you want to filter a specific source port range filter with this ACE, you can enter a specific source port range value. A field for entering a source port value appears. The allowed range is 0 to 65535. A frame that hits this ACE matches this source port value.</li> </ul>								
<ul style="list-style-type: none"> <li>• <b>Destination Port</b></li> </ul>	<p>Specify the destination port for this ACE.</p> <ul style="list-style-type: none"> <li>■ <b>Any:</b> No specific destination port is specified (destination port status is "don't-care").</li> <li>■ <b>Single:</b> If you want to filter a specific destination port with this ACE, you can enter a specific destination port value. A field for entering a destination port value appears. The allowed range is 0 to 65535. A frame that hits this ACE matches this destination port value.</li> <li>■ <b>Range:</b> If you want to filter a specific destination port range filter with this ACE, you can enter a specific destination port range value. A field for entering a destination port value appears.</li> </ul>								
<ul style="list-style-type: none"> <li>• <b>TCP Flags</b></li> </ul>	<table border="1"> <tr> <td data-bbox="523 824 625 1160">UGR</td> <td data-bbox="625 824 1404 1160"> <p>Specify the TCP "Urgent Pointer field significant" (URG) value for this ACE.</p> <ul style="list-style-type: none"> <li>■ <b>Set:</b> TCP frames where the URG field is set must be able to match this entry.</li> <li>■ <b>Unset:</b> TCP frames where the URG field is set must not be able to match this entry.</li> <li>■ <b>Don't Care:</b> Any value is allowed ("don't-care").</li> </ul> </td> </tr> <tr> <td data-bbox="523 1160 625 1496">ACK</td> <td data-bbox="625 1160 1404 1496"> <p>Specify the TCP "Acknowledgment field significant" (ACK) value for this ACE.</p> <ul style="list-style-type: none"> <li>■ <b>Set:</b> TCP frames where the ACK field is set must be able to match this entry.</li> <li>■ <b>Unset:</b> TCP frames where the ACK field is set must not be able to match this entry.</li> <li>■ <b>Don't Care:</b> Any value is allowed ("don't-care").</li> </ul> </td> </tr> <tr> <td data-bbox="523 1496 625 1787">PSH</td> <td data-bbox="625 1496 1404 1787"> <p>Specify the TCP "Push Function" (PSH) value for this ACE.</p> <ul style="list-style-type: none"> <li>■ <b>Set:</b> TCP frames where the PSH field is set must be able to match this entry.</li> <li>■ <b>Unset:</b> TCP frames where the PSH field is set must not be able to match this entry.</li> <li>■ <b>Don't Care:</b> Any value is allowed ("don't-care").</li> </ul> </td> </tr> <tr> <td data-bbox="523 1787 625 2078">RST</td> <td data-bbox="625 1787 1404 2078"> <p>Specify the TCP "Reset the connection" (RST) value for this ACE.</p> <ul style="list-style-type: none"> <li>■ <b>Set:</b> TCP frames where the RST field is set must be able to match this entry.</li> <li>■ <b>Unset:</b> TCP frames where the RST field is set must not be able to match this entry.</li> <li>■ <b>Don't Care:</b> Any value is allowed ("don't-care").</li> </ul> </td> </tr> </table>	UGR	<p>Specify the TCP "Urgent Pointer field significant" (URG) value for this ACE.</p> <ul style="list-style-type: none"> <li>■ <b>Set:</b> TCP frames where the URG field is set must be able to match this entry.</li> <li>■ <b>Unset:</b> TCP frames where the URG field is set must not be able to match this entry.</li> <li>■ <b>Don't Care:</b> Any value is allowed ("don't-care").</li> </ul>	ACK	<p>Specify the TCP "Acknowledgment field significant" (ACK) value for this ACE.</p> <ul style="list-style-type: none"> <li>■ <b>Set:</b> TCP frames where the ACK field is set must be able to match this entry.</li> <li>■ <b>Unset:</b> TCP frames where the ACK field is set must not be able to match this entry.</li> <li>■ <b>Don't Care:</b> Any value is allowed ("don't-care").</li> </ul>	PSH	<p>Specify the TCP "Push Function" (PSH) value for this ACE.</p> <ul style="list-style-type: none"> <li>■ <b>Set:</b> TCP frames where the PSH field is set must be able to match this entry.</li> <li>■ <b>Unset:</b> TCP frames where the PSH field is set must not be able to match this entry.</li> <li>■ <b>Don't Care:</b> Any value is allowed ("don't-care").</li> </ul>	RST	<p>Specify the TCP "Reset the connection" (RST) value for this ACE.</p> <ul style="list-style-type: none"> <li>■ <b>Set:</b> TCP frames where the RST field is set must be able to match this entry.</li> <li>■ <b>Unset:</b> TCP frames where the RST field is set must not be able to match this entry.</li> <li>■ <b>Don't Care:</b> Any value is allowed ("don't-care").</li> </ul>
UGR	<p>Specify the TCP "Urgent Pointer field significant" (URG) value for this ACE.</p> <ul style="list-style-type: none"> <li>■ <b>Set:</b> TCP frames where the URG field is set must be able to match this entry.</li> <li>■ <b>Unset:</b> TCP frames where the URG field is set must not be able to match this entry.</li> <li>■ <b>Don't Care:</b> Any value is allowed ("don't-care").</li> </ul>								
ACK	<p>Specify the TCP "Acknowledgment field significant" (ACK) value for this ACE.</p> <ul style="list-style-type: none"> <li>■ <b>Set:</b> TCP frames where the ACK field is set must be able to match this entry.</li> <li>■ <b>Unset:</b> TCP frames where the ACK field is set must not be able to match this entry.</li> <li>■ <b>Don't Care:</b> Any value is allowed ("don't-care").</li> </ul>								
PSH	<p>Specify the TCP "Push Function" (PSH) value for this ACE.</p> <ul style="list-style-type: none"> <li>■ <b>Set:</b> TCP frames where the PSH field is set must be able to match this entry.</li> <li>■ <b>Unset:</b> TCP frames where the PSH field is set must not be able to match this entry.</li> <li>■ <b>Don't Care:</b> Any value is allowed ("don't-care").</li> </ul>								
RST	<p>Specify the TCP "Reset the connection" (RST) value for this ACE.</p> <ul style="list-style-type: none"> <li>■ <b>Set:</b> TCP frames where the RST field is set must be able to match this entry.</li> <li>■ <b>Unset:</b> TCP frames where the RST field is set must not be able to match this entry.</li> <li>■ <b>Don't Care:</b> Any value is allowed ("don't-care").</li> </ul>								

	SYN	<p>Specify the TCP "Synchronize sequence numbers" (SYN) value for this ACE.</p> <ul style="list-style-type: none"> <li>■ <b>Set:</b> TCP frames where the SYN field is set must be able to match this entry.</li> <li>■ <b>Unset:</b> TCP frames where the SYN field is set must not be able to match this entry.</li> <li>■ <b>Don't Care:</b> Any value is allowed ("don't-care").</li> </ul>
	FIN	<p>Specify the TCP "No more data from sender" (FIN) value for this ACE.</p> <ul style="list-style-type: none"> <li>■ <b>Set:</b> TCP frames where the FIN field is set must be able to match this entry.</li> <li>■ <b>Unset:</b> TCP frames where the FIN field is set must not be able to match this entry.</li> <li>■ <b>Don't Care:</b> Any value is allowed ("don't-care").</li> </ul>
<ul style="list-style-type: none"> <li>• <b>Type of Service</b></li> </ul>		<p>Specify the type of service for this ACE.</p> <ul style="list-style-type: none"> <li>■ <b>Any:</b> No specific type of service is specified (destination port status is "don't-care").</li> <li>■ <b>DSCP:</b> If you want to filter a specific DSCP with this ACE, you can enter a specific DSCP value. A field for entering a DSCP value appears. The allowed range is 0 to 63. A frame that hits this ACE matches this DSCP value.</li> <li>■ <b>IP Precedence:</b> If you want to filter a specific IP precedence with this ACE, you can enter a specific IP precedence value. A field for entering an IP precedence value appears. The allowed range is 0 to 7. A frame that hits this ACE matches this IP precedence value.</li> </ul>
<ul style="list-style-type: none"> <li>• <b>ICMP</b></li> </ul>		<p>Specify the ICMP for this ACE.</p> <ul style="list-style-type: none"> <li>■ <b>Any:</b> No specific ICMP is specified (destination port status is "don't-care").</li> <li>■ <b>List:</b> If you want to filter a specific list with this ACE, you can select a specific list value.</li> <li>■ <b>Protocol ID:</b> If you want to filter a specific protocol ID filter with this ACE, you can enter a specific protocol ID value. A field for entering a protocol ID value appears. The allowed range is 0 to 255. A frame that hits this ACE matches this protocol ID value.</li> </ul>
<ul style="list-style-type: none"> <li>• <b>ICMP Code</b></li> </ul>		<p>Specify the ICMP code filter for this ACE.</p> <ul style="list-style-type: none"> <li>■ <b>Any:</b> No ICMP code filter is specified (ICMP code filter status is "don't-care").</li> <li>■ <b>User Defined:</b> If you want to filter a specific ICMP code filter with this ACE, you can enter a specific ICMP code value. A field for entering an ICMP code value appears. The allowed range is 0 to 255. A frame that hits this ACE matches this ICMP code value.</li> </ul>

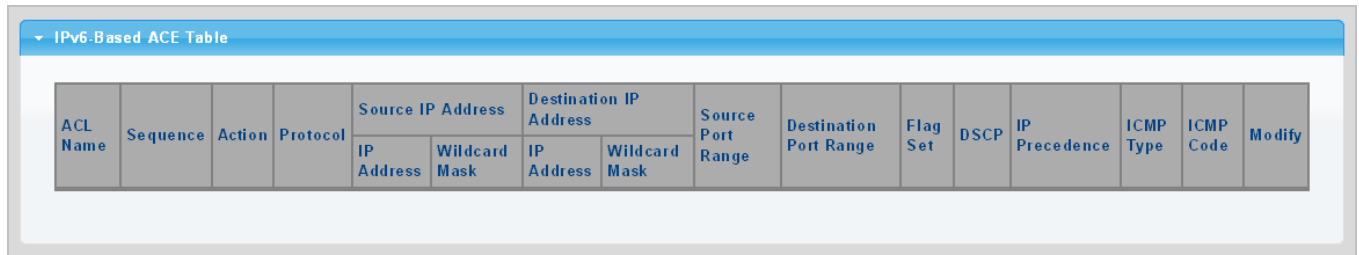

**Buttons**

 : Click to add ACE list



**Figure 4-10-12** IPv6-based ACE Table Page Screenshot

The page includes the following fields:

Object	Description
• <b>ACL Name</b>	Displays the current ACL name
• <b>Sequence</b>	Displays the current sequence
• <b>Action</b>	Displays the current action
• <b>Protocol</b>	Displays the current protocol
• <b>Source IP Address</b>	Displays the current source IP address
• <b>Source IP Address Wildcard Mask</b>	Displays the current source IP address wildcard mask
• <b>Destination IP Address</b>	Displays the current destination IP address
• <b>Destination IP Address Wildcard Mask</b>	Displays the current destination IP address wildcard mask
• <b>Source Port Range</b>	Displays the current source port range
• <b>Destination Port Range</b>	Displays the current destination port range
• <b>Flag Set</b>	Displays the current flag set
• <b>DSCP</b>	Displays the current DSCP
• <b>IP Precedence</b>	Displays the current IP precedence
• <b>ICMP Type</b>	Displays the current ICMP Type
• <b>ICMP Code</b>	Displays the current ICMP code
• <b>Modify</b>	<p>Click  to edit IPv6-based ACL parameter.</p> <p>Click  to delete IPv6-based ACL entry.</p>

### 4.10.7 ACL Binding

This page allows you to bind the Policy content to the appropriate ACLs. The ACL Policy screens in [Figure 4-10-13](#) & [Figure 4-10-14](#) appears.

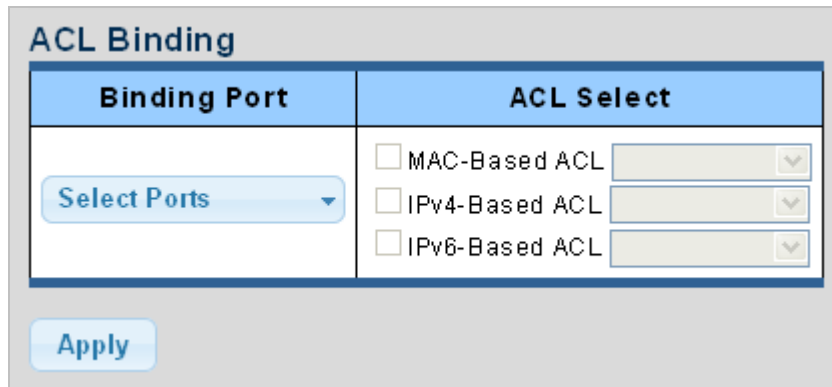

Figure 4-10-13 ACL Binding Page Screenshot

The page includes the following fields:

Object	Description
• Binding Port	Select port from this drop-down list
• ACL Select	Select ACL list for this drop down list

#### Buttons

: Click to apply changes.

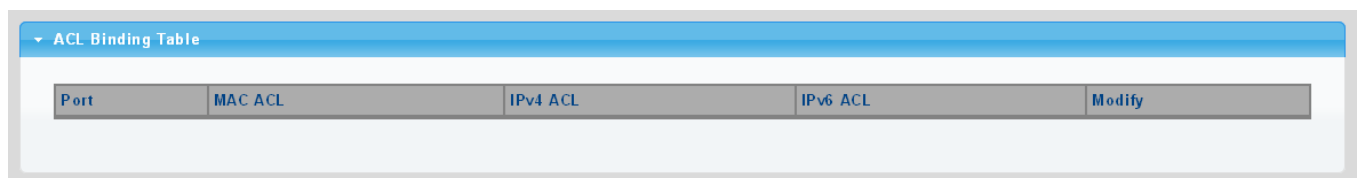



Figure 4-10-14 ACL Binding Table Page Screenshot

The page includes the following fields:

Object	Description
• Port	The switch port number of the logical port
• MAC ACL	Displays the current MAC ACL
• IPv4 ACL	Displays the current IPv4 ACL
• IPv6 ACL	Displays the current IPv6 ACL
• Modify	Click  to edit ACL binding table parameter Click  to delete ACL binding entry

## 4.11 MAC Address Table

Switching of frames is based upon the DMAC address contained in the frame. The Industrial Managed Switch builds up a table that maps MAC addresses to switch ports for knowing which ports the frames should go to (based upon the DMAC address in the frame). This table contains both static and dynamic entries. The static entries are configured by the network administrator if the administrator wants to do a fixed mapping between the DMAC address and switch ports.

The frames also contain a MAC address (SMAC address), which shows the MAC address of the equipment sending the frame. The SMAC address is used by the switch to automatically update the MAC table with these dynamic MAC addresses. Dynamic entries are removed from the MAC table if no frame with the corresponding SMAC address has been seen after a configurable age time.

### 4.11.1 Static MAC Setting

The static entries in the MAC table are shown in this table. The MAC table is sorted first by VLAN ID and then by MAC address. The Static MAC Setting screens in [Figure 4-11-1](#) & [Figure 4-11-2](#) appear.

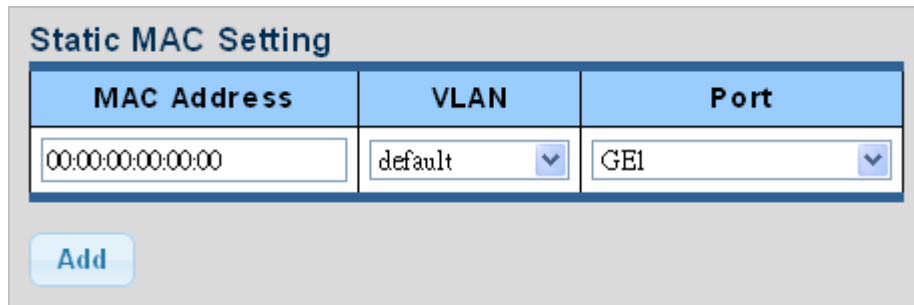

Figure 4-11-1 Statics MAC Setting Page Screenshot

The page includes the following fields:

Object	Description
• <b>MAC Address</b>	Physical address associated with this interface
• <b>VLAN</b>	Select VLAN from this drop-down list
• <b>Port</b>	Select port from this drop-down list

#### Buttons

**Add**: Click to add new static MAC address.

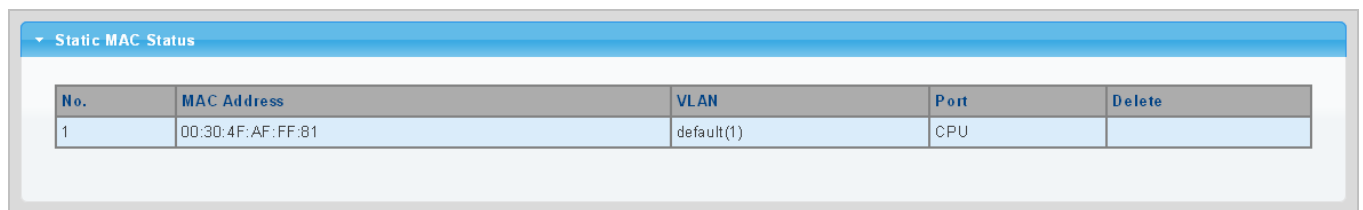

Figure 4-11-2 Statics MAC Status Page Screenshot

The page includes the following fields:

Object	Description
• <b>No.</b>	This is the number for entries
• <b>MAC Address</b>	The MAC address for the entry
• <b>VLAN</b>	The VLAN ID for the entry
• <b>Port</b>	Displays the current port
• <b>Delete</b>	Click <b>Delete</b> to delete static MAC status entry



### 4.11.2 MAC Filtering

By filtering MAC address, the switch can easily filter the per-configured MAC address and reduce the un-safety. The Static MAC Setting screens in [Figure 4-11-3](#) & [Figure 4-11-4](#) appear.

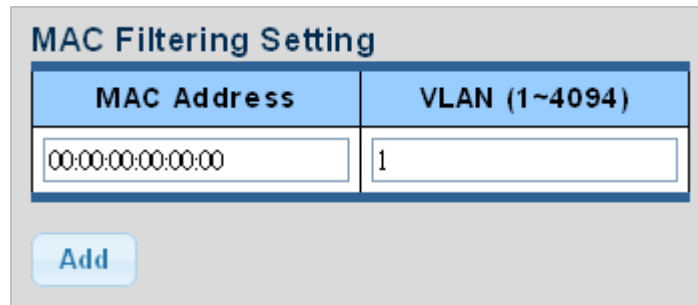

The screenshot shows a form titled "MAC Filtering Setting". It contains two input fields: "MAC Address" with the value "00:00:00:00:00:00" and "VLAN (1~4094)" with the value "1". Below the fields is a blue "Add" button.

Figure 4-11-3 MAC Filtering Setting Page Screenshot

The page includes the following fields:

Object	Description
• <b>MAC Address</b>	Physical address associated with this interface
• <b>VLAN (1~4096)</b>	Indicates the ID of this particular VLAN

#### Buttons

 : Click to add new MAC filtering setting.

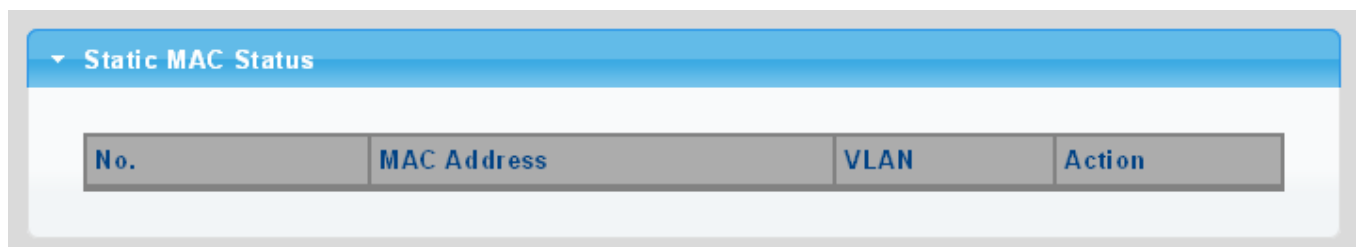

The screenshot shows a section titled "Static MAC Status" with a dropdown arrow. Below it is a table with the following headers: "No.", "MAC Address", "VLAN", and "Action".

Figure 4-11-4 Statics MAC Status Page Screenshot

The page includes the following fields:

Object	Description
• <b>No.</b>	This is the number for entries
• <b>MAC Address</b>	The MAC address for the entry
• <b>VLAN</b>	The VLAN ID for the entry
• <b>Delete</b>	Click  to delete static MAC status entry.

### 4.11.3 Dynamic Address Setting

By default, dynamic entries are removed from the MAC table after 300 seconds. The Dynamic Address Setting/Status screens in [Figure 4-11-5](#) & [Figure 4-11-6](#) appear.

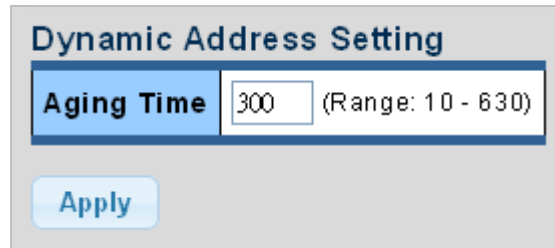

**Figure 4-11-5** Dynamic Addresses Setting Page Screenshot

The page includes the following fields:

Object	Description
<ul style="list-style-type: none"> <li>• <b>Aging Time</b></li> </ul>	The time after which a learned entry is discarded Range: 10-630 seconds; Default: <b>300 seconds</b>

#### Buttons

: Click to apply changes.

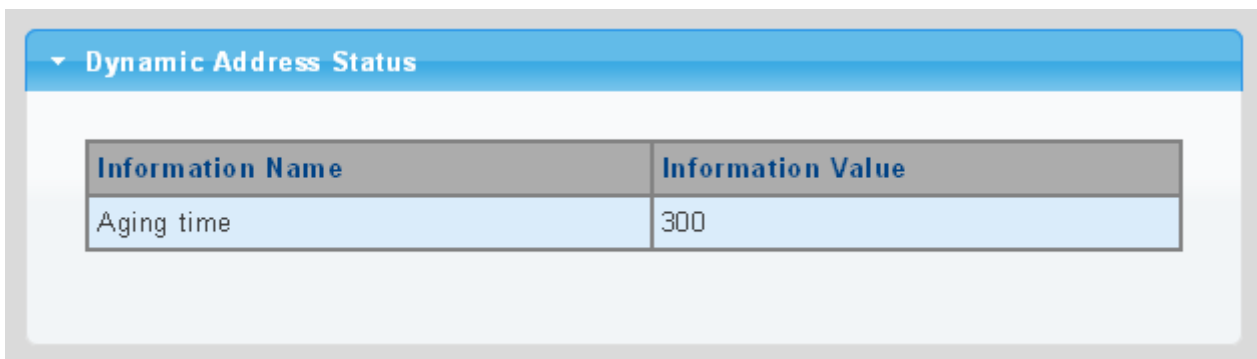

**Figure 4-11-6** Dynamic Addresses Status Page Screenshot

The page includes the following fields:

Object	Description
<ul style="list-style-type: none"> <li>• <b>Aging Time</b></li> </ul>	Displays the current aging time

### 4.11.4 Dynamic Learned

#### Dynamic MAC Table

Dynamic Learned MAC Table is shown on this page. The MAC Table is sorted first by VLAN ID and then by MAC address. The Dynamic Learned screens in [Figure 4-11-6](#) & [Figure 4-11-7](#) appear.

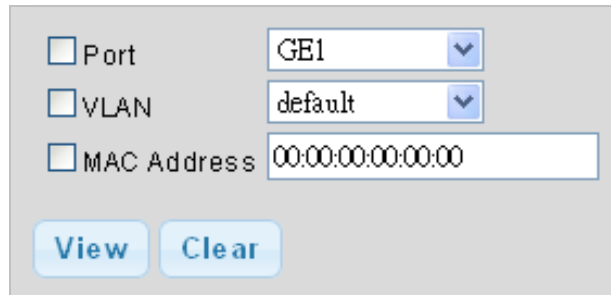

Figure 4-11-6 Dynamic Learned Page Screenshot

The page includes the following fields:

Object	Description
• Port	Select port from this drop-down list
• VLAN	Select VLAN from this drop-down list
• MAC Address	Physical address associated with this interface

#### Buttons

**View**: Refreshes the displayed table starting from the "Start from MAC address" and "VLAN" input fields

**Clear**: Flushes all dynamic entries

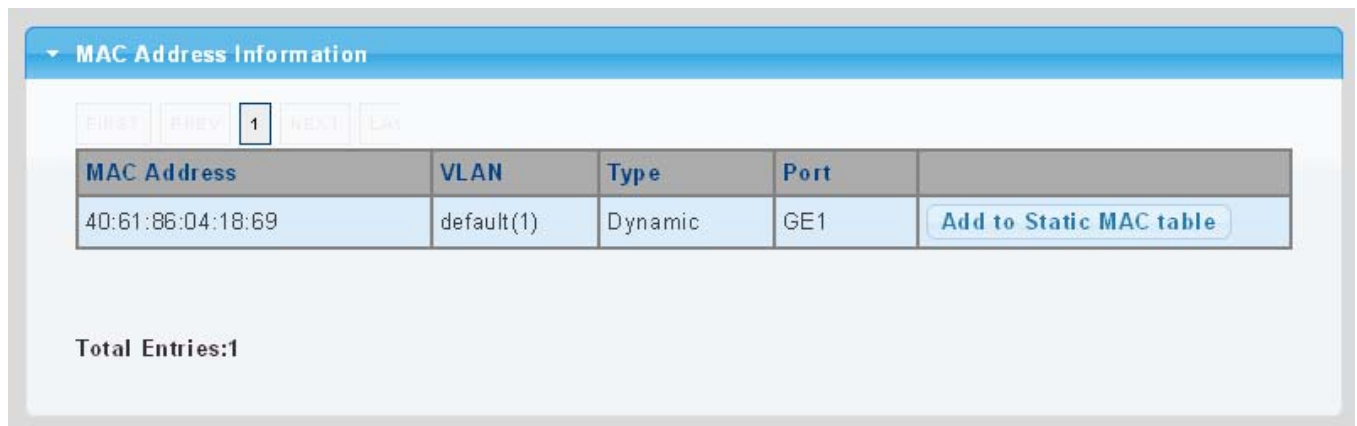

MAC Address	VLAN	Type	Port
40:61:86:04:18:69	default(1)	Dynamic	GE1

Total Entries:1

Figure 4-11-7 MAC Address Information Page Screenshot

Object	Description
• <b>MAC Address</b>	The MAC address of the entry
• <b>VLAN</b>	The VLAN ID of the entry
• <b>Type</b>	Indicates whether the entry is a static or dynamic entry
• <b>Port</b>	The ports that are members of the entry

**Buttons**

**Add to Static MAC table** : Click to add dynamic MAC address to static MAC address.

## 4.12 LLDP

### 4.12.1 Link Layer Discovery Protocol

**Link Layer Discovery Protocol (LLDP)** is used to discover basic information about neighboring devices on the local broadcast domain. LLDP is a Layer 2 protocol that uses periodic broadcasts to advertise information about the sending device. Advertised information is represented in **Type Length Value (TLV)** format according to the IEEE 802.1ab standard, and can include details such as device identification, capabilities and configuration settings. LLDP also defines how to store and maintain information gathered about the neighboring network nodes it discovers.

**Link Layer Discovery Protocol - Media Endpoint Discovery (LLDP-MED)** is an extension of LLDP intended for managing endpoint devices such as Voice over IP phones and network switches. The LLDP-MED TLVs advertise information such as network policy, power, inventory, and device location details. LLDP and LLDP-MED information can be used by SNMP applications to simplify troubleshooting, enhance network management, and maintain an accurate network topology.

### 4.12.2 LLDP Global Setting

This Page allows the user to inspect and configure the current LLDP port settings. The LLDP Global Setting and Config screens in [Figure 4-12-1](#) & [Figure 4-12-2](#) appear.

**Global Settings**

<b>Enabled</b>	<input checked="" type="radio"/> Enabled <input type="radio"/> Disabled
<b>LLDP PDU Disable Action</b>	<input type="radio"/> Filtering <input type="radio"/> Bridging <input checked="" type="radio"/> Flooding
<b>Transmission Interval</b>	<input type="text" value="30"/> (5-32768)
<b>Holdtime Multiplier</b>	<input type="text" value="4"/> (2-10)
<b>Reinitialization Delay</b>	<input type="text" value="2"/> (1-10)
<b>Transmit Delay</b>	<input type="text" value="2"/> (1-8192)
<b>LLDP-MED Fast Start Repeat Count</b>	<input type="text" value="3"/> (1-10)

Figure 4-12-1 Global Setting Page Screenshot

The page includes the following fields:

Object	Description
<ul style="list-style-type: none"> <li>• <b>Enable</b></li> </ul>	Globally enable or disable LLDP function
<ul style="list-style-type: none"> <li>• <b>LLDP PDU Disable Action</b></li> </ul>	Set LLDP PDU disable action: include "Filtering", "Bridging" and "Flooding". <ul style="list-style-type: none"> <li>■ <b>Filtering</b>: discard all LLDP PDU.</li> <li>■ <b>Bridging</b>: transmit LLDP PDU in the same VLAN.</li> <li>■ <b>Flooding</b>: transmit LLDP PDU for all port.</li> </ul>
<ul style="list-style-type: none"> <li>• <b>Transmission Interval</b></li> </ul>	The switch is periodically transmitting LLDP frames to its neighbors for having the network discovery information up-to-date. The interval between each LLDP frame is determined by the <b>Transmission Interval</b> value. Valid values are restricted to 5 - 32768 seconds. Default: <b>30</b> seconds  This attribute must comply with the following rule: (Transmission Interval * Hold Time Multiplier) ≤ 65536, and Transmission Interval ≥ (4 * Delay Interval)
<ul style="list-style-type: none"> <li>• <b>Holdtime Multiplier</b></li> </ul>	Each LLDP frame contains information about how long the information in the LLDP frame shall be considered valid. The LLDP information valid period is set to <b>Holdtime</b> multiplied by <b>Transmission Interval</b> seconds. Valid values are restricted to 2 - 10 times.  TTL in seconds is based on the following rule:

	<p>(Transmission Interval * Holdtime Multiplier) ≤ 65536.</p> <p>Therefore, the default TTL is 4*30 = 120 seconds.</p>
<ul style="list-style-type: none"> <li>• <b>Reinitialization Delay</b></li> </ul>	<p>When a port is disabled, LLDP is disabled or the switch is rebooted a LLDP shutdown frame is transmitted to the neighboring units, signaling that the LLDP information isn't valid anymore. <b>Tx Reinit</b> controls the amount of seconds between the shutdown frame and a new LLDP initialization. Valid values are restricted to 1 - 10 seconds.</p>
<ul style="list-style-type: none"> <li>• <b>Transmit Delay</b></li> </ul>	<p>If some configuration is changed (e.g. the IP address) a new LLDP frame is transmitted, but the time between the LLDP frames will always be at least the value of <b>Transmit Delay</b> seconds. <b>Transmit Delay</b> cannot be larger than 1/4 of the <b>Transmission Interval</b> value. Valid values are restricted to 1 - 8192 seconds.</p> <p>This attribute must comply with the rule:</p> <p><math>(4 * \text{Delay Interval}) \leq \text{Transmission Interval}</math></p>
<ul style="list-style-type: none"> <li>• <b>LLDP-MED Fast Start Repeat Count</b></li> </ul>	<p>Configures the amount of LLDP MED Fast Start LLDPDUs to transmit during the activation process of the LLDP-MED Fast Start mechanism.</p> <p>Range: 1-10 packets;</p> <p>Default: <b>3</b> packets</p> <p>The MED Fast Start Count parameter is part of the timer which ensures that the LLDP-MED Fast Start mechanism is active for the port. LLDP-MED Fast Start is critical to the timely startup of LLDP, and therefore integral to the rapid availability of Emergency Call Service.</p>

**Buttons**

: Click to apply changes.

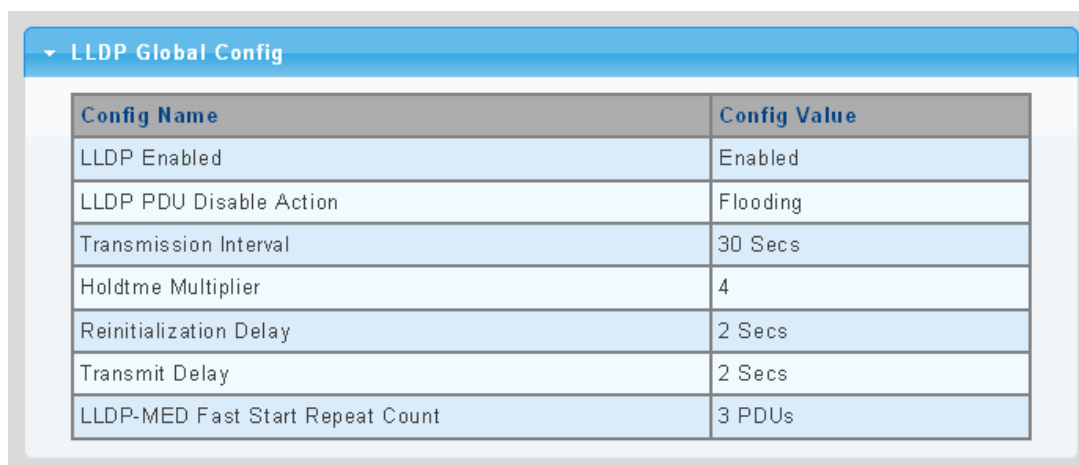

LLDP Global Config	
Config Name	Config Value
LLDP Enabled	Enabled
LLDP PDU Disable Action	Flooding
Transmission Interval	30 Secs
Holdtme Multiplier	4
Reinitialization Delay	2 Secs
Transmit Delay	2 Secs
LLDP-MED Fast Start Repeat Count	3 PDUs

Figure 4-12-2 LLDP Global Config Page Screenshot

The page includes the following fields:

Object	Description
• <b>LLDP Enable</b>	Displays the current LLDP status
• <b>LLDP PDU Disable Action</b>	Displays the current LLDP PDU disable action
• <b>Transmission Interval</b>	Displays the current transmission interval
• <b>Holdtime Multiplier</b>	Displays the current holdtime multiplier
• <b>Reinitialization Delay</b>	Displays the current reinitialization delay
• <b>Transmit Delay</b>	Displays the current transmit delay
• <b>LLDP-MED Fast Start Repeat Count</b>	Displays the current LLDP-MED Fast Start Repeat Count

### 4.12.3 LLDP Port Setting

Use the LLDP Port Setting to specify the message attributes for individual interfaces, including whether messages are transmitted, received, or both transmitted and received. The LLDP Port Configuration and Status screens in [Figure 4-12-3](#) & [Figure 4-12-4](#) appear.

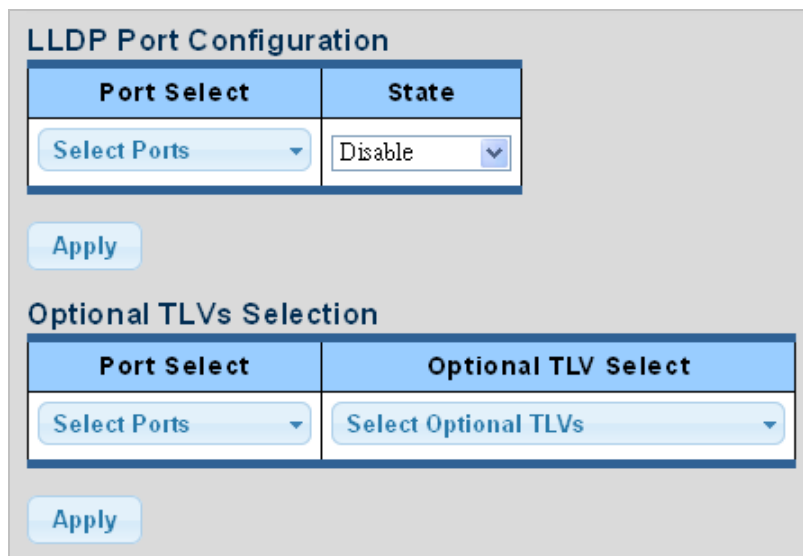

Figure 4-12-3 LLDP Port Configuration and Optional TLVs Selection Page Screenshot

The page includes the following fields:

Object	Description
• <b>Port Select</b>	Select port from this drop-down list
• <b>State</b>	Enables LLDP messages transmit and receive modes for LLDP Protocol Data Units. Options: <input checked="" type="checkbox"/> <b>Tx only</b>



	<ul style="list-style-type: none"> <li>■ Rx only</li> <li>■ TxRx</li> <li>■ Disabled</li> </ul>
• Port Select	Select port for this drop down list
• Optional TLV Select	<p>Configures the information included in the TLV field of advertised messages.</p> <ul style="list-style-type: none"> <li>■ <b>System Name:</b> When checked the "System Name" is included in LLDP information transmitted.</li> <li>■ <b>Port Description:</b> When checked the "Port Description" is included in LLDP information transmitted.</li> <li>■ <b>System Description:</b> When checked the "System Description" is included in LLDP information transmitted.</li> <li>■ <b>System Capability:</b> When checked the "System Capability" is included in LLDP information transmitted.</li> <li>■ <b>802.3 MAC-PHY:</b> When checked the "802.3 MAC-PHY" is included in LLDP information transmitted.</li> <li>■ <b>802.3 Link Aggregation:</b> When checked the "802.3 Link Aggregation" is included in LLDP information transmitted.</li> <li>■ <b>802.3 Maximum Frame Size:</b> When checked the "802.3 Maximum Frame Size" is included in LLDP information transmitted.</li> <li>■ <b>Management Address:</b> When checked the "Management Address" is included in LLDP information transmitted.</li> <li>■ <b>802.1 PVID:</b> When checked the "802.1 PVID" is included in LLDP information transmitted.</li> </ul>

**Buttons**

 : Click to apply changes

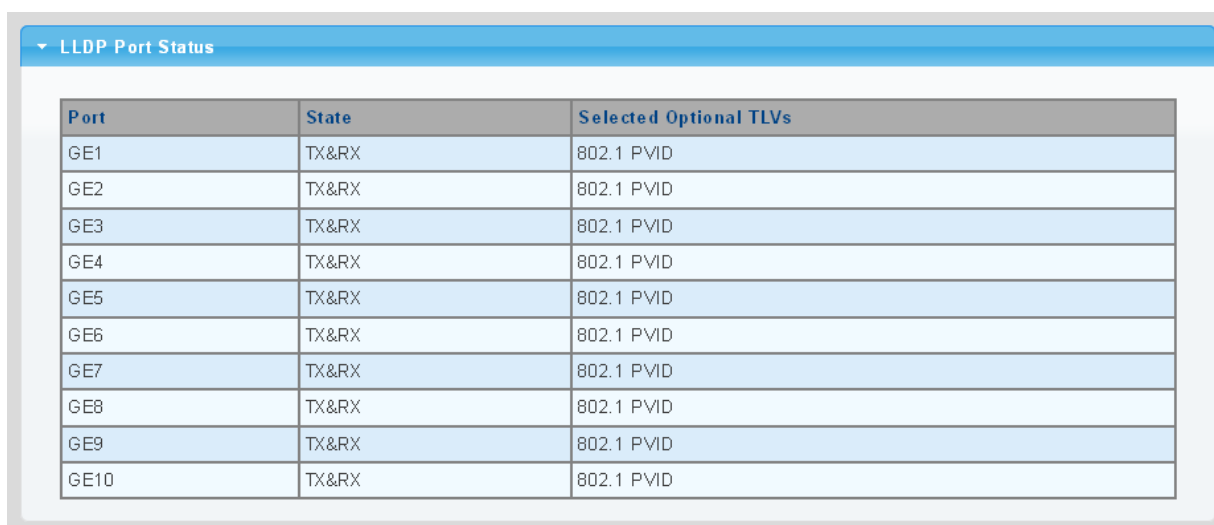

Port	State	Selected Optional TLVs
GE1	TX&RX	802.1 PVID
GE2	TX&RX	802.1 PVID
GE3	TX&RX	802.1 PVID
GE4	TX&RX	802.1 PVID
GE5	TX&RX	802.1 PVID
GE6	TX&RX	802.1 PVID
GE7	TX&RX	802.1 PVID
GE8	TX&RX	802.1 PVID
GE9	TX&RX	802.1 PVID
GE10	TX&RX	802.1 PVID

Figure 4-12-4 LLDP Port Status Page Screenshot

The page includes the following fields:

Object	Description
• Port	The switch port number of the logical port
• State	Displays the current LLDP status
• Selected Optional TLVs	Displays the current selected optional TLVs

The VLAN Name TLV VLAN Selection and LLDP Port VLAN TLV Status screens in [Figure 4-12-5](#) & [Figure 4-12-6](#) appear.

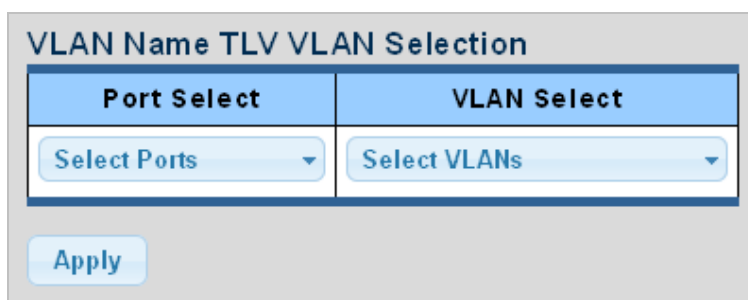

Figure 4-12-5 VLAN Name TLV Selection Page Screenshot

The page includes the following fields:

Object	Description
• Port Select	Select port from this drop-down list.
• VLAN Select	Select VLAN from this drop-down list.

**Buttons**

: Click to apply changes.

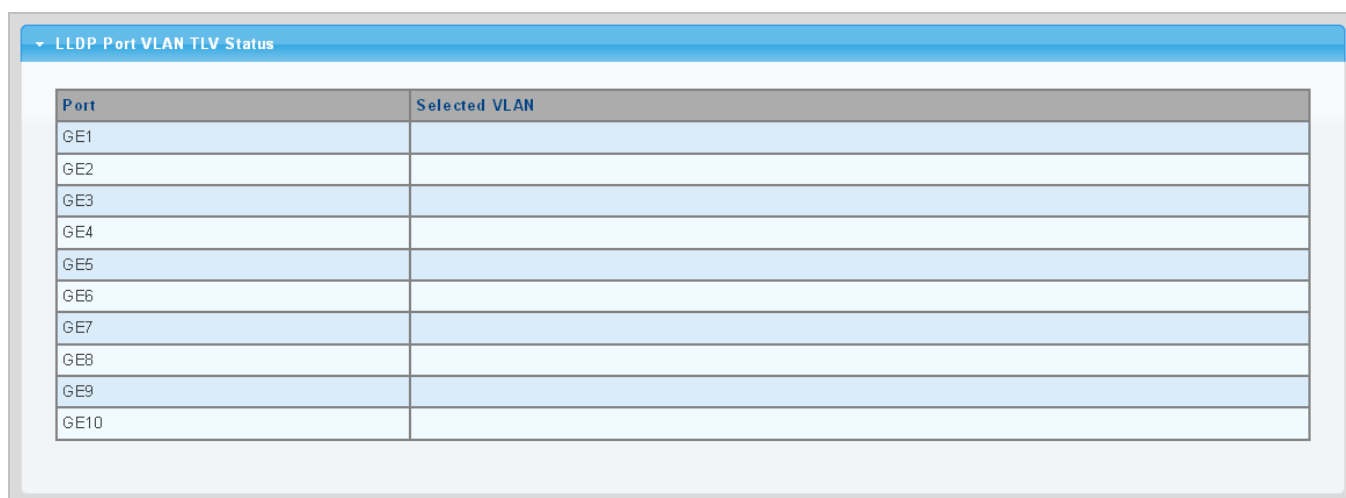

Figure 4-12-6 LLDP Port VLAN TLV Status Page Screenshot

The page includes the following fields:

Object	Description
• Port	The switch port number of the logical port
• Selected VLAN	Displays the currently selected VLAN

#### 4.12.4 LLDP Local Device

Use the LLDP Local Device Information screen to display information about the switch, such as its **MAC address**, **chassis ID**, **management IP address**, and **port information**. The Local Device Summary and Port Status screens in [Figure 4-12-7](#) & [Figure 4-12-8](#) appear.

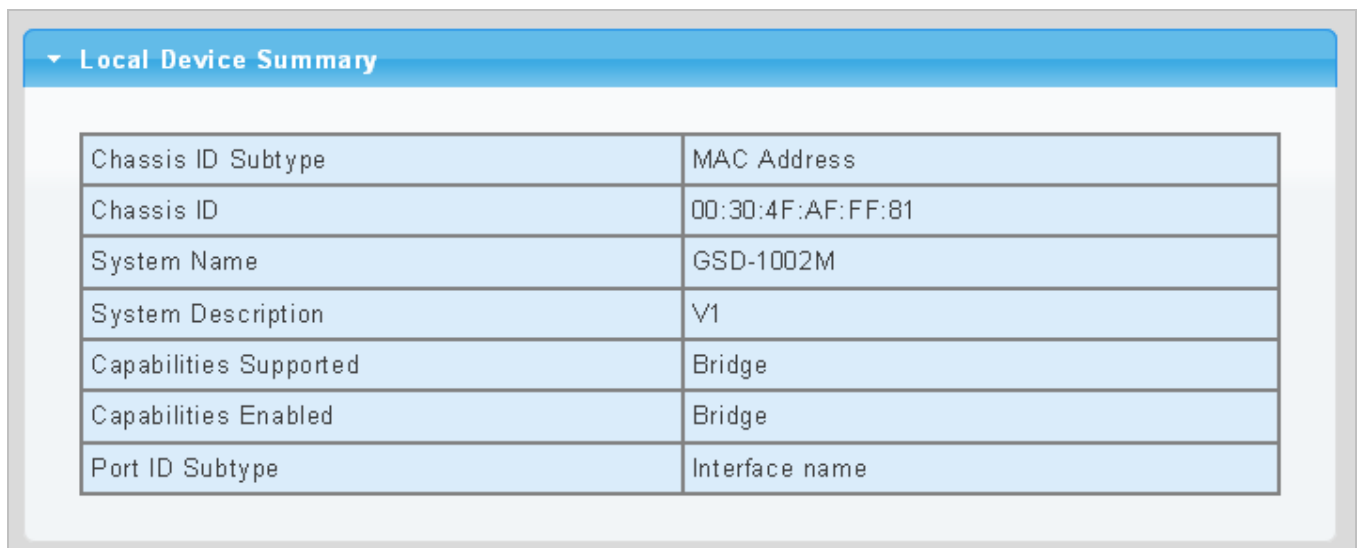

Local Device Summary	
Chassis ID Subtype	MAC Address
Chassis ID	00:30:4F:AF:FF:81
System Name	GSD-1002M
System Description	V1
Capabilities Supported	Bridge
Capabilities Enabled	Bridge
Port ID Subtype	Interface name

Figure 4-12-7 Local Device Summary Page Screenshot

The page includes the following fields:

Object	Description
• Chassis ID Subtype	Displays the current chassis ID subtype
• Chassis ID	Displays the current chassis ID
• System Name	Displays the current system name
• System Description	Displays the current system description
• Capabilities Supported	Displays the current capabilities supported
• Capabilities Enabled	Displays the current capabilities enabled
• Port ID Subtype	Displays the current port ID subtype

▼ Port Status

Detail

	Interface	LLDP Status	LLDP Med Status
<input type="radio"/>	GE1	TX & RX	Enabled
<input type="radio"/>	GE2	TX & RX	Enabled
<input type="radio"/>	GE3	TX & RX	Enabled
<input type="radio"/>	GE4	TX & RX	Enabled
<input type="radio"/>	GE5	TX & RX	Enabled
<input type="radio"/>	GE6	TX & RX	Enabled
<input type="radio"/>	GE7	TX & RX	Enabled
<input type="radio"/>	GE8	TX & RX	Enabled
<input type="radio"/>	GE9	TX & RX	Enabled
<input type="radio"/>	GE10	TX & RX	Enabled

Figure 4-12-8 Port Status Page Screenshot

The page includes the following fields:

Object	Description
• <b>Interface</b>	The switch port number of the logical port.
• <b>LLDP Status</b>	Displays the current LLDP status
• <b>LLDP MED Status</b>	Displays the current LLDP MED Status

### 4.12.5 LLDP Remove Device

This Page provides a status overview for all LLDP remove devices. The displayed table contains a row for each port on which an LLDP neighbor is detected. The LLDP Remove Device screen in [Figure 4-12-9](#) appears.

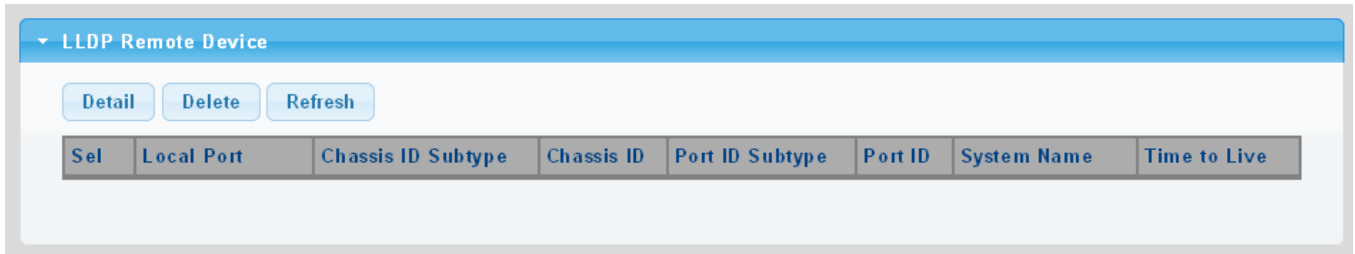

**Figure 4-12-9** LLDP Remote Device Page Screenshot

The page includes the following fields:

Object	Description
• <b>Local Port</b>	Displays the current local port
• <b>Chassis ID Subtype</b>	Displays the current chassis ID subtype
• <b>Chassis ID</b>	The Chassis ID is the identification of the neighbor's LLDP frames
• <b>Port ID Subtype</b>	Displays the current port ID subtype
• <b>Port ID</b>	The Remote Port ID is the identification of the neighbor port
• <b>System Name</b>	System Name is the name advertised by the neighbor unit
• <b>Time to Live</b>	Displays the current time to live

#### Buttons

**Delete** : Click to delete LLDP remove device entry.

**Refresh** : Click to refresh LLDP remove device.

## 4.12.6 MED Network Policy

Network Policy Discovery enables the efficient discovery and diagnosis of mismatch issues with the VLAN configuration, along with the associated Layer 2 and Layer 3 attributes, which apply for a set of specific protocol applications on that port. Improper network policy configurations are a very significant issue in VoIP environments that frequently result in voice quality degradation or loss of service.

Policies are only intended for use with applications that have specific 'real-time' network policy requirements, such as interactive voice and/or video services.

The network policy attributes advertised are:

1. Layer 2 VLAN ID (IEEE 802.1Q-2003)
2. Layer 2 priority value (IEEE 802.1D-2004)
3. Layer 3 Diffserv code point (DSCP) value (IETF RFC 2474)

This network policy is potentially advertised and associated with multiple sets of application types supported on a given port.

The application types specifically addressed are:

1. Voice
2. Guest Voice
3. Softphone Voice
4. Video Conferencing
5. Streaming Video
6. Control / Signaling (conditionally support a separate network policy for the media types above)

A large network may support multiple VoIP policies across the entire organization, and different policies per application type. LLDP-MED allows multiple policies to be advertised per port, each corresponding to a different application type. Different ports on the same Network Connectivity Device may advertise different sets of policies, based on the authenticated user identity or port configuration.

It should be noted that LLDP-MED is not intended to run on links other than between Network Connectivity Devices and Endpoints, and therefore does not need to advertise the multitude of network policies that frequently run on an aggregated link interior to the LAN.

The Voice Auto Mode Configuration, Network Policy Configuration and LLDP MED Network Policy Table screen in [Figure 4-12-10](#) & [Figure 4-12-11](#) appears.

### Voice Auto Mode Configuration

**LLDP MED Policy for Voice Application**

 Auto
  Manual

Apply

### Network Policy Configuration

<b>Network Policy Number</b>	1 <input type="button" value="v"/>
<b>Application</b>	Voice <input type="button" value="v"/>
<b>VLAN ID</b>	1 (1-4094)
<b>VLAN Tag</b>	<input checked="" type="radio"/> Tagged <input type="radio"/> Untagged
<b>L2 Priority</b>	0 (0-7)
<b>DSCP Value</b>	0 (0-63)

Apply

Figure 4-12-10 Voice Auto Mode Configuration and Network Policy Configuration Page Screenshot

The page includes the following fields:

Object	Description
<ul style="list-style-type: none"> <li>• <b>LLDP MED Policy for Voice Application</b></li> </ul>	Set the LLDP MED policy for voice application mode
<ul style="list-style-type: none"> <li>• <b>Network Policy Number</b></li> </ul>	Select network policy number for this drop down list
<ul style="list-style-type: none"> <li>• <b>Application Type</b></li> </ul>	<p>Intended use of the application types:</p> <p><b>Voice</b> - for use by dedicated IP Telephony handsets and other similar appliances supporting interactive voice services. These devices are typically deployed on a separate VLAN for ease of deployment and enhanced security by isolation from data applications.</p> <p><b>Voice Signaling</b> - for use in network topologies that require a different policy for the voice signaling than for the voice media. This application type should not be advertised if all the same network policies apply as those advertised in the Voice application policy.</p> <p><b>Guest Voice</b> - support a separate 'limited feature-set' voice service for guest users and visitors with their own IP Telephony handsets and other similar appliances supporting interactive voice services.</p> <p><b>Guest Voice Signaling</b> - for use in network topologies that require a different policy for the guest voice signaling than for the guest voice media. This application type should not be advertised if all the same network policies apply as</p>

	<p>those advertised in the Guest Voice application policy.</p> <p><b>Softphone Voice</b> - for use by softphone applications on typical data centric devices, such as PCs or laptops. This class of endpoints frequently does not support multiple VLANs, if at all, and are typically configured to use an 'untagged' VLAN or a single 'tagged' data specific VLAN. When a network policy is defined for use with an 'untagged' VLAN (see Tagged flag below), then the L2 priority field is ignored and only the DSCP value has relevance.</p> <p><b>Video Conferencing</b> - for use by dedicated Video Conferencing equipment and other similar appliances supporting real-time interactive video/audio services.</p> <p><b>App Streaming Video</b> - for use by broadcast or multicast based video content distribution and other similar applications supporting streaming video services that require specific network policy treatment. Video applications relying on TCP with buffering would not be an intended use of this application type.</p> <p><b>Video Signaling</b> - for use in network topologies that require a separate policy for the video signaling than for the video media. This application type should not be advertised if all the same network policies apply as those advertised in the Video Conferencing application policy.</p>
<ul style="list-style-type: none"> <li>• <b>VLAN ID</b></li> </ul>	<p>VLAN identifier (VID) for the port as defined in IEEE 802.1Q-2003</p>
<ul style="list-style-type: none"> <li>• <b>Tag</b></li> </ul>	<p><b>Tag</b> indicating whether the specified application type is using a 'tagged' or an 'untagged' VLAN.</p> <p><b>Untagged</b> indicates that the device is using an untagged frame format and as such does not include a tag header as defined by IEEE 802.1Q-2003. In this case, both the VLAN ID and the Layer 2 priority fields are ignored and only the DSCP value has relevance.</p> <p><b>Tagged</b> indicates that the device is using the IEEE 802.1Q tagged frame format, and that both the VLAN ID and the Layer 2 priority values are being used, as well as the DSCP value. The tagged format includes an additional field, known as the tag header. The tagged frame format also includes priority tagged frames as defined by IEEE 802.1Q-2003.</p>
<ul style="list-style-type: none"> <li>• <b>L2 Priority</b></li> </ul>	<p>L2 Priority is the Layer 2 priority to be used for the specified application type. L2 Priority may specify one of eight priority levels (0 through 7), as defined by IEEE 802.1D-2004. A value of 0 represents use of the default priority as defined in IEEE 802.1D-2004.</p>
<ul style="list-style-type: none"> <li>• <b>DSCP</b></li> </ul>	<p>DSCP value to be used to provide Diffserv node behavior for the specified application type as defined in IETF RFC 2474. DSCP may contain one of 64 code point values (0 through 63). A value of 0 represents use of the default DSCP value as defined in RFC 2475.</p>



**Buttons**

: Click to apply changes.

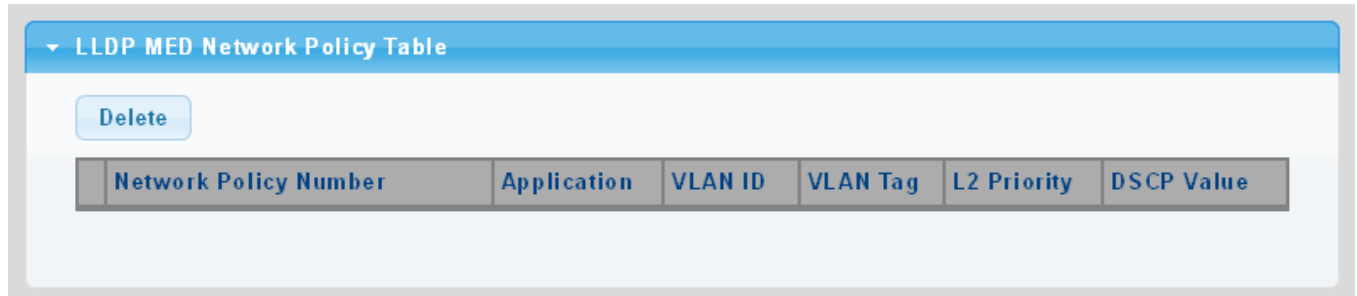

**Figure 4-12-11** LLDP MED Network Policy Table Page Screenshot

The page includes the following fields:

Object	Description
• <b>Network Policy Number</b>	Displays the current network policy number
• <b>Application</b>	Displays the current application
• <b>VLAN ID</b>	Displays the current VLAN ID
• <b>VLAN Tag</b>	Displays the current VLAN tag status
• <b>L2 Priority</b>	Displays the current L2 priority
• <b>DSCP Value</b>	Displays the current DSCP value

**Buttons**

: Click to delete LLDP MED network policy table entry.

### 4.12.7 MED Port Setting

The Port LLDP MED Configuration/Port Setting Table screens in [Figure 4-12-12](#) & [Figure 4-12-13](#) appear.

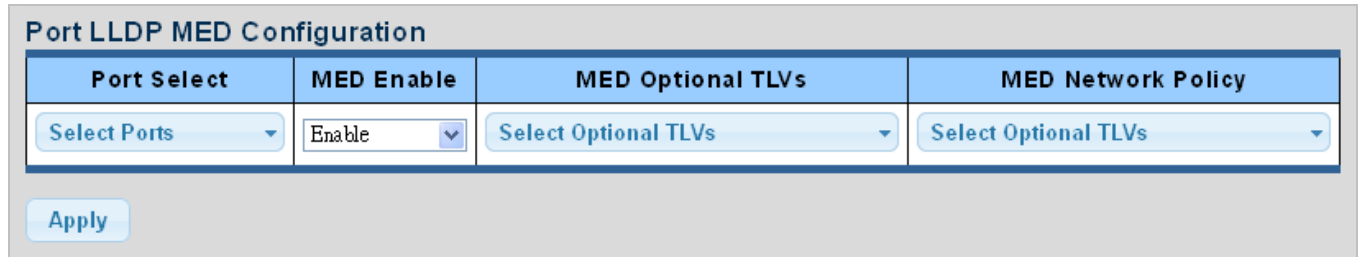

Figure 4-12-12 Port LLDP MED Configuration Page Screenshot

The page includes the following fields:

Object	Description
<ul style="list-style-type: none"> <li>• <b>Port Select</b></li> </ul>	Select port from this drop-down list
<ul style="list-style-type: none"> <li>• <b>MED Enable</b></li> </ul>	Enable or disable MED configuration
<ul style="list-style-type: none"> <li>• <b>MED Optional TLVs</b></li> </ul>	<p>Configures the information included in the MED TLV field of advertised messages.</p> <p><b>-Network Policy</b> – This option advertises network policy configuration information, aiding in the discovery and diagnosis of VLAN configuration mismatches on a port. Improper network policy configurations frequently result in voice quality degradation or complete service disruption.</p> <p><b>-Location</b> – This option advertises location identification details.</p> <p><b>-Inventory</b> – This option advertises device details useful for inventory management, such as manufacturer, model, software version and other pertinent information.</p>
<ul style="list-style-type: none"> <li>• <b>MED Network Policy</b></li> </ul>	Select MED network policy for this drop down list

#### Buttons

: Click to apply changes.

LLDP MED Port Setting Table

Interface	LLDP MED Status	User Defined Network Policy		Location	Inventory
		Active	Application		
GE1	Enabled	Yes		No	No
GE2	Enabled	Yes		No	No
GE3	Enabled	Yes		No	No
GE4	Enabled	Yes		No	No
GE5	Enabled	Yes		No	No
GE6	Enabled	Yes		No	No
GE7	Enabled	Yes		No	No
GE8	Enabled	Yes		No	No
GE9	Enabled	Yes		No	No
GE10	Enabled	Yes		No	No

Figure 4-12-13 Port LLDP MED Configuration Page Screenshot

The page includes the following fields:

Object	Description
• Interface	The switch port number of the logical port
• LLDP MED Status	Displays the current LLDP MED status
• Active	Displays the current active status
• Application	Displays the current application
• Location	Displays the current location
• Inventory	Displays the current inventory

The MED Location Configuration and LLDP MED Port Location Table screens in Figure 4-12-14 & Figure 4-12-15 appear.

MED Location Configuration

Ports	Select Ports
Location Coordinate	<input type="text"/> (16 pairs of hexadecimal characters)
Location Civic Address	<input type="text"/> (6-160 pairs of hexadecimal characters)
Location ECS ELIN	<input type="text"/> (10-25 pairs of hexadecimal characters)

Apply

Figure 4-12-14 Port LLDP MED Configuration Page Screenshot

The page includes the following fields:

Object	Description
• Port	Select port from this drop-down list
• Location Coordinate	A string identifying the Location Coordinate that this entry should belong to
• Location Civic Address	A string identifying the Location Civic Address that this entry should belong to
• Location ESC ELIN	A string identifying the Location ESC ELIN that this entry should belong to

**Buttons**

: Click to apply changes.

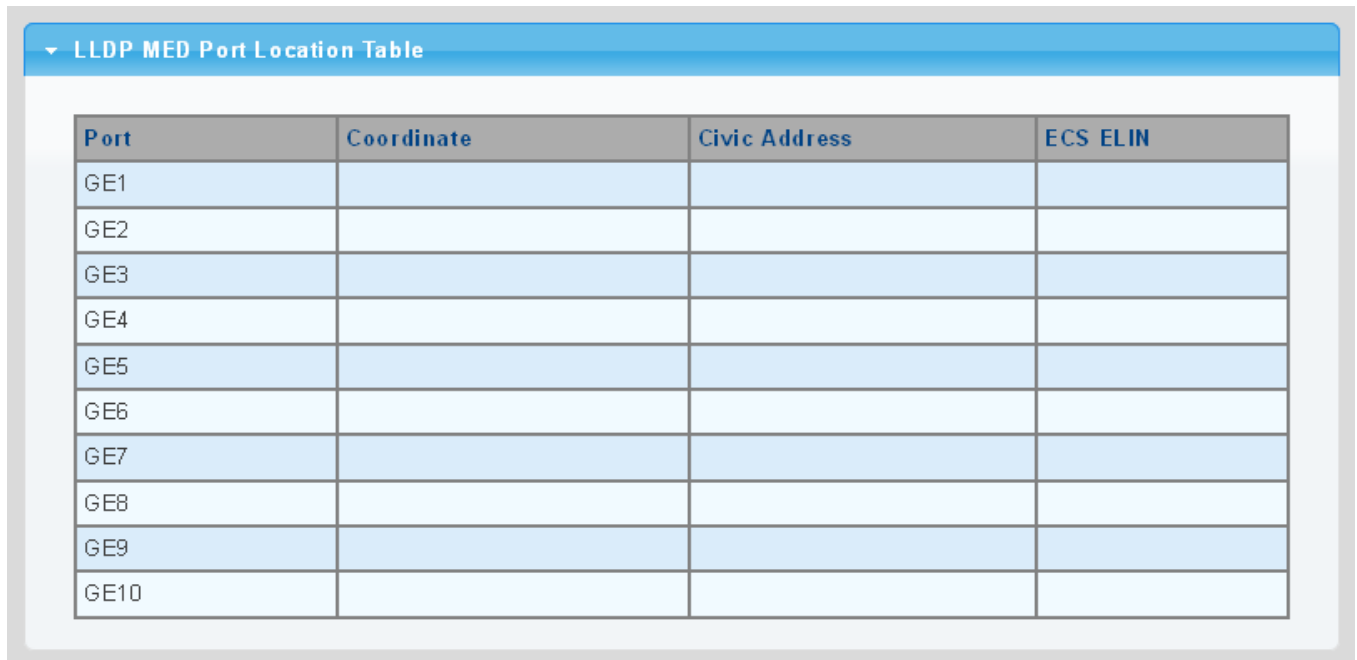

Figure 4-12-15 LLDP MED Port Location Table Page Screenshot

The page includes the following fields:

Object	Description
• Port	The switch port number of the logical port
• Coordinate	Displays the current coordinate
• Civic Address	Displays the current civic address
• ESC ELIN	Displays the current ESC ELIN

### 4.12.8 LLDP Overloading

The LLDP Port Overloading screen in [Figure 4-12-16](#) appears.

LLDP Port Overloading Table												
Interface	Total(Bytes)	Left to Send(Bytes)	Status	Status								
				Mandatory TLVs	MED Capabilities	MED Location	MED Network Policy	MED Extended Power via MDI	802.3 TLVs	Optional TLVs	MED Inventory	802.1 TLVs
GE1	48	1440	Not Overloading	21(Transmitted)	9(Transmitted)		10(Transmitted)					8(Transmitted)
GE2	48	1440	Not Overloading	21(Transmitted)	9(Transmitted)		10(Transmitted)					8(Transmitted)
GE3	48	1440	Not Overloading	21(Transmitted)	9(Transmitted)		10(Transmitted)					8(Transmitted)
GE4	48	1440	Not Overloading	21(Transmitted)	9(Transmitted)		10(Transmitted)					8(Transmitted)
GE5	48	1440	Not Overloading	21(Transmitted)	9(Transmitted)		10(Transmitted)					8(Transmitted)
GE6	48	1440	Not Overloading	21(Transmitted)	9(Transmitted)		10(Transmitted)					8(Transmitted)
GE7	48	1440	Not Overloading	21(Transmitted)	9(Transmitted)		10(Transmitted)					8(Transmitted)
GE8	48	1440	Not Overloading	21(Transmitted)	9(Transmitted)		10(Transmitted)					8(Transmitted)
GE9	48	1440	Not Overloading	21(Transmitted)	9(Transmitted)		10(Transmitted)					8(Transmitted)
GE10	49	1439	Not Overloading	22(Transmitted)	9(Transmitted)		10(Transmitted)					8(Transmitted)

Figure 4-12-16 LLDP Port Overloading Table Page Screenshot

The page includes the following fields:

Object	Description
• Interface	The switch port number of the logical port
• Total (Bytes)	Total number of bytes of LLDP information that is normally sent in a packet
• Left to Send (Bytes)	Total number of available bytes that can also send LLDP information in a packet
• Status	Gives the status of the TLVs
• Mandatory TLVs	Displays if the mandatory group of TLVs were transmitted or overloaded
• MED Capabilities	Displays if the capabilities packets were transmitted or overloaded
• MED Location	Displays if the location packets were transmitted or overloaded
• MED Network Policy	Displays if the network policies packets were transmitted or overloaded
• MED Extended Power via MDI	Displays if the extended power via MDI packets were transmitted or overloaded
• 802.3 TLVs	Displays if the 802.3 TLVs were transmitted or overloaded
• Optional TLVs	If the LLDP MED extended power via MDI packets were sent, or if they were overloaded

• <b>MED Inventory</b>	Displays if the mandatory group of TLVs was transmitted or overloaded
• <b>802.1 TLVs</b>	Displays if the 802.1 TLVs were transmitted or overloaded

### 4.12.9 LLDP Statistics

Use the LLDP Device Statistics screen to general statistics for LLDP-capable devices attached to the switch, and for LLDP protocol messages transmitted or received on all local interfaces. The LLDP Global and Port Statistics screens in [Figure 4-12-17](#) & [Figure 4-12-18](#) appear.

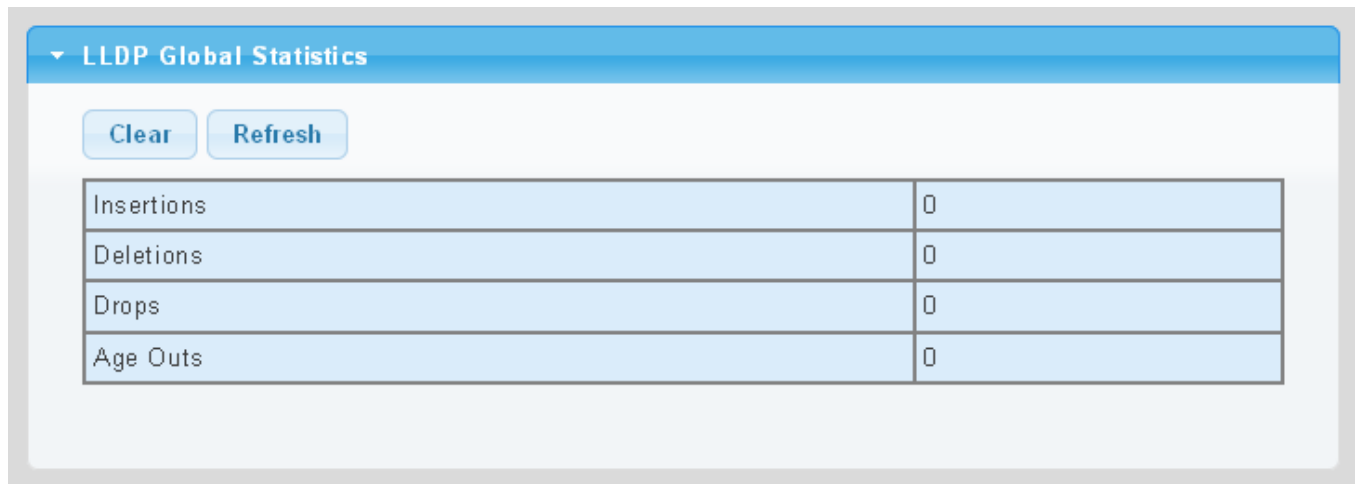



Figure 4-12-17 LLDP Global Statistics Page Screenshot

The page includes the following fields:

Object	Description
• <b>Insertions</b>	Shows the number of new entries added since switch reboot.\
• <b>Deletions</b>	Shows the number of new entries deleted since switch reboot.\
• <b>Drops</b>	Shows the number of LLDP frames dropped due to that the entry table was full.\
• <b>Age Outs</b>	Shows the number of entries deleted due to Time-To-Live expiring.\

#### Buttons

 : Click to clear the statistics

 : Click to refresh the statistics

LLDP Port Statistics

Port	TX Frames	RX Frames			RX TLVs		RX Ageouts
	Total	Total	Discarded	Errors	Discarded	Unrecognized	Total
GE1	136	0	0	0	0	0	0
GE2	0	0	0	0	0	0	0
GE3	0	0	0	0	0	0	0
GE4	0	0	0	0	0	0	0
GE5	0	0	0	0	0	0	0
GE6	0	0	0	0	0	0	0
GE7	0	0	0	0	0	0	0
GE8	0	0	0	0	0	0	0
GE9	0	0	0	0	0	0	0
GE10	0	0	0	0	0	0	0

Figure 4-12-18 LLDP Port Statistics Page Screenshot

The page includes the following fields:

Object	Description
• Port	The port on which LLDP frames are received or transmitted
• TX Frame – Total	The number of LLDP frames transmitted on the port
• RX Frame – Total	The number of LLDP frames received on the port
• RX Frame – Discarded	If an LLDP frame is received on a port, and the switch's internal table has run full, the LLDP frame is counted and discarded. This situation is known as "Too Many Neighbors" in the LLDP standard. LLDP frames require a new entry in the table when the Chassis ID or Remote Port ID is not already contained within the table. Entries are removed from the table when a given port links down, an LLDP shutdown frame is received, or when the entry ages out.
• RX Frame – Error	The number of received LLDP frames containing some kind of error.
• RX TLVs – Discarded	Each LLDP frame can contain multiple pieces of information, known as TLVs (TLV is short for "Type Length Value"). If a TLV is malformed, it is counted and discarded.
• RX TLVs – Unrecognized	The number of well-formed TLVs, but with an unknown type value
• RX Ageout - Total	The number of organizationally TLVs received

## 4.13 Diagnostics

This section provide the Physical layer and IP layer network diagnostics tools for troubleshoot. The diagnostic tools are designed for network manager to help them quickly diagnose problems between point to point and better service customers.

Use the Diagnostics menu items to display and configure basic administrative details of the Industrial Managed Switch. Under System the following topics are provided to configure and view the system information:

This section has the following items:

- **Cable Diagnostics**
- **Ping Test**
- **IPv6 Ping Test**
- **Trace Route**

### 4.13.1 Cable Diagnostics

The Cable Diagnostics performs tests on copper cables. These functions have the ability to identify the cable length and operating conditions, and to isolate a variety of common faults that can occur on the Cat5 twisted-pair cabling. There might be two statuses as follow:

- If the link is established on the twisted-pair interface in 1000Base-T mode, the Cable Diagnostics can run without disruption of the link or of any data transfer.
- If the link is established in 100Base-TX or 10Base-T, the Cable Diagnostics cause the link to drop while the diagnostics are running.

After the diagnostics are finished, the link is reestablished. And the following functions are available.

- Coupling between cable pairs.
- Cable pair termination
- Cable Length



---

Cable Diagnostics is only accurate for cables of length from 15 to 100 meters.

---



The Copper test and test result screens in [Figure 4-13-1](#) & [Figure 4-13-2](#) appear.

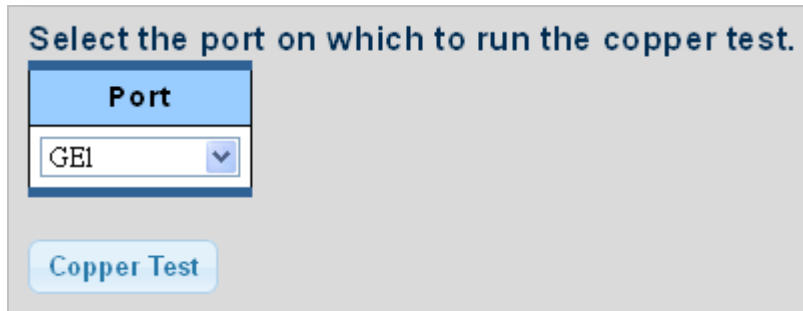

Figure 4-13-1 Copper Test Page Screenshot

The page includes the following fields:

Object	Description
<ul style="list-style-type: none"> <li>Port</li> </ul>	Select port from this drop-down list

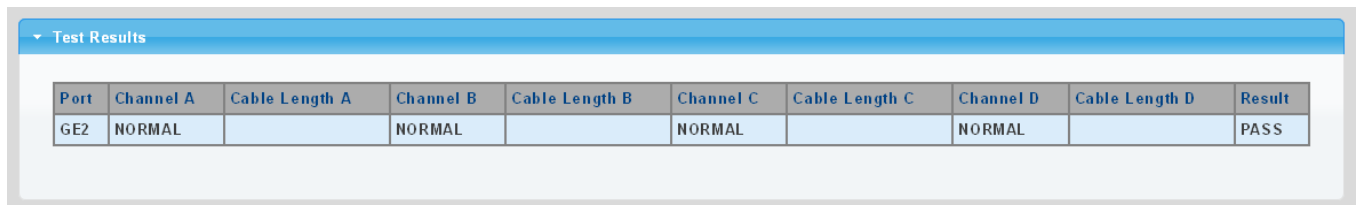

Figure 4-13-2 Test Results Page Screenshot

The page includes the following fields:

Object	Description
<ul style="list-style-type: none"> <li>Port</li> </ul>	The port where you are requesting Cable Diagnostics
<ul style="list-style-type: none"> <li>Channel A~D</li> </ul>	Displays the current channel status
<ul style="list-style-type: none"> <li>Cable Length A~D</li> </ul>	Displays the current cable length
<ul style="list-style-type: none"> <li>Result</li> </ul>	Displays the test result

### 4.13.2 Ping

The ping and IPv6 ping allow you to issue ICMP PING packets to troubleshoot IP connectivity issues. The Industrial Managed Switch transmits ICMP packets, and the sequence number and roundtrip time are displayed upon reception of a reply.

### 4.13.3 Ping Test

This page allows you to issue ICMP PING packets to troubleshoot IP connectivity issues.

After you press “**Apply**”, ICMP packets are transmitted, and the sequence number and roundtrip time are displayed upon reception of a reply. The page refreshes automatically until responses to all packets are received, or until a timeout occurs. The ICMP Ping screen in [Figure 4-13-3](#) appears.

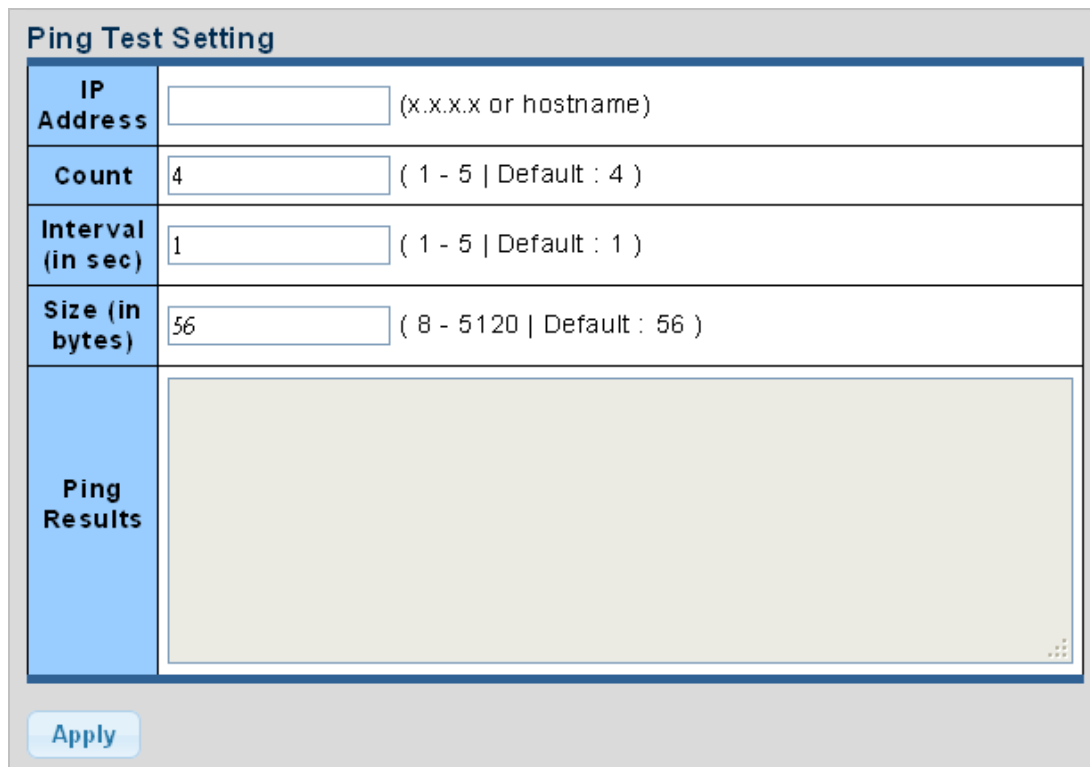



Figure 4-13-3 ICMP Ping Page Screenshot

The page includes the following fields:

Object	Description
• IP Address	The destination IP Address
• Count	Number of echo requests to send
• Interval (in sec)	Send interval for each ICMP packet
• Size (in bytes)	The payload size of the ICMP packet. Values range from 8bytes to 5120bytes.
• Ping Results	Displays the current ping result.

#### Buttons

: Click to transmit ICMP packets.



Be sure the target IP Address is within the same network subnet of the switch, or you have to set up the correct gateway IP address.

### 4.13.4 IPv6 Ping Test

This page allows you to issue ICMPv6 PING packets to troubleshoot IPv6 connectivity issues.

After you press “Apply”, 5 ICMPv6 packets are transmitted, and the sequence number and roundtrip time are displayed upon reception of a reply. The page refreshes automatically until responses to all packets are received, or until a timeout occurs. The ICMPv6 Ping screen in [Figure 4-13-4](#) appears.

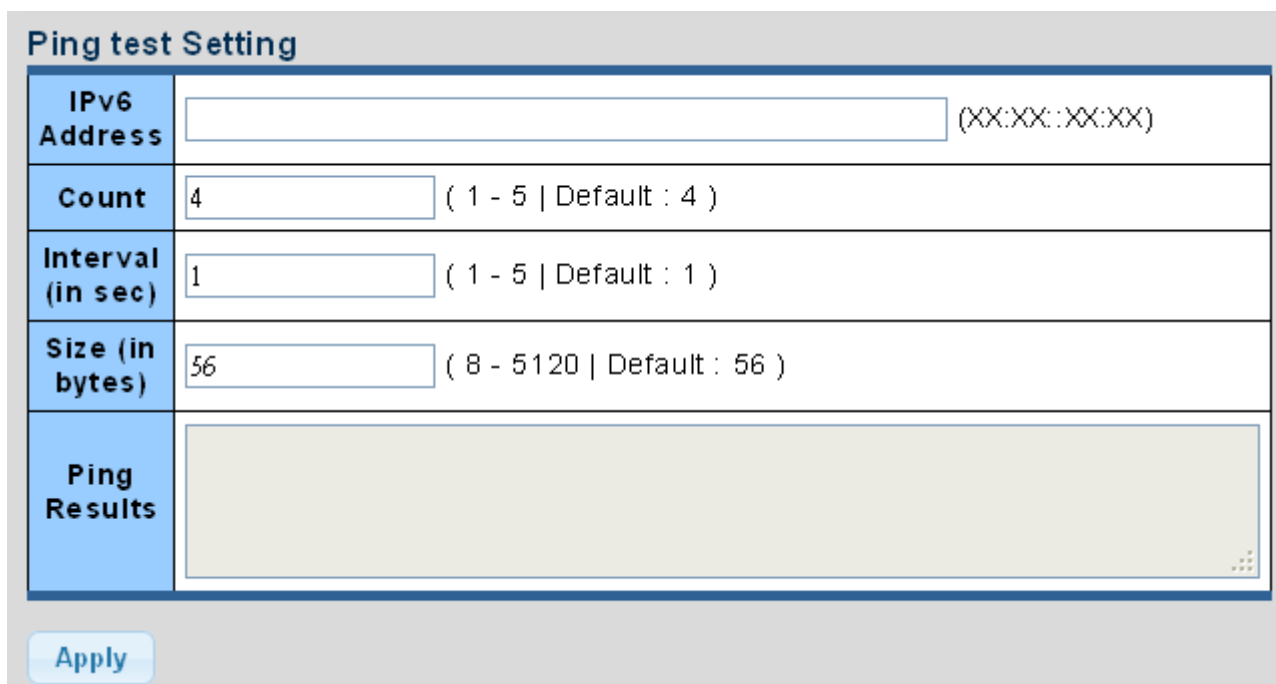

Ping test Setting	
IPv6 Address	<input type="text"/> (XX:XX:XX:XX)
Count	<input type="text" value="4"/> ( 1 - 5   Default : 4 )
Interval (in sec)	<input type="text" value="1"/> ( 1 - 5   Default : 1 )
Size (in bytes)	<input type="text" value="56"/> ( 8 - 5120   Default : 56 )
Ping Results	<div style="border: 1px solid gray; height: 60px; width: 100%;"></div>

Figure 4-13-4 ICMPv6 Ping Page Screenshot

The page includes the following fields:

Object	Description
• IP Address	The destination IPv6 Address
• Count	Number of echo requests to send
• Interval (in sec)	Send interval for each ICMP packet
• Size (in bytes)	The payload size of the ICMP packet. Values range from 8bytes to 5120bytes
• Ping Results	Displays the current ping result

#### Buttons

: Click to transmit ICMPv6 packets

### 4.13.5 Trace Router

Traceroute function is for testing the gateways through which the data packets travel from the source device to the destination device, so to check the network accessibility and locate the network failure.

Execution procedure of the Traceroute function consists of: first a data packet with TTL at 1 is sent to the destination address, if the first hop returns an ICMP error message to inform this packet can not be sent (due to TTL timeout), a data packet with TTL at 2 will be sent. Also the send hop may be a TTL timeout return, but the procedure will carries on till the data packet is sent to its destination. These procedures is for recording every source address which returned ICMP TTL timeout message, so to describe a path the IP data packets traveled to reach the destination. The Trace Route Setting screen in [Figure 4-13-5](#) appears.

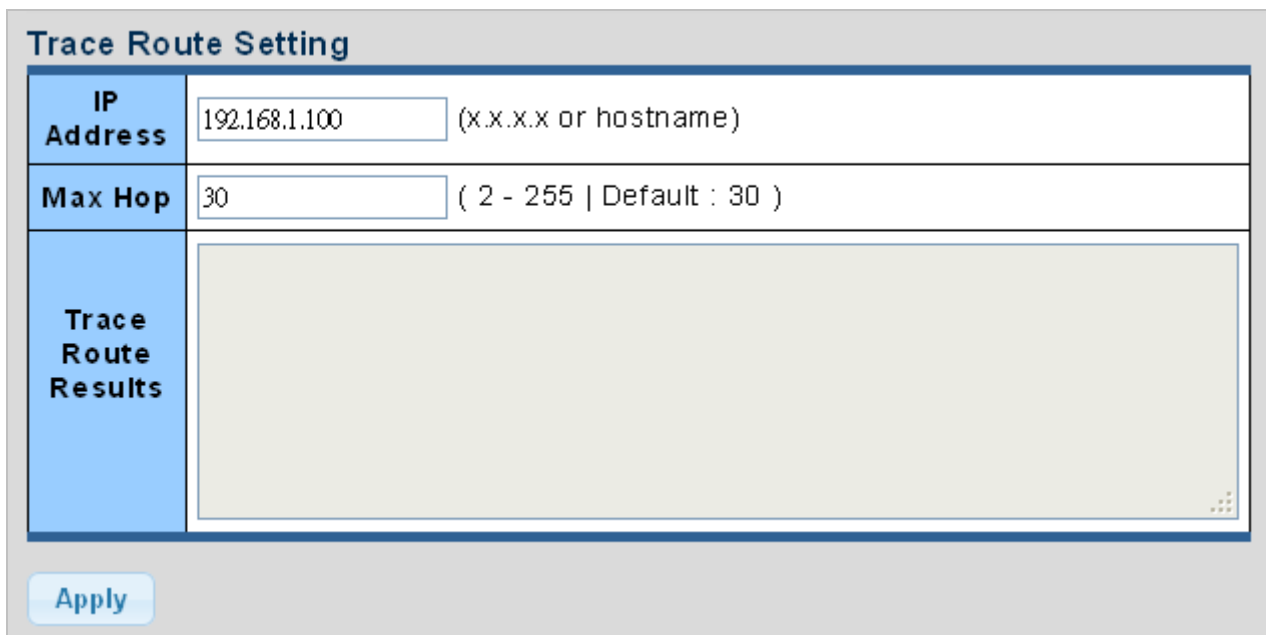

**Figure 4-13-5** Trace Route Setting Page Screenshot

The page includes the following fields:

Object	Description
• IP Address	The destination IP Address
• Max Hop	The maximum gateway number allowed by traceroute function
• Trace Route Results	Displays the current trace route result

#### Buttons

: Click to transmit ICMPv6 packets

## 4.14 RMON

RMON is the most important expansion of the standard SNMP. RMON is a set of MIB definitions, used to define standard network monitor functions and interfaces, enabling the communication between SNMP management terminals and remote monitors. RMON provides a highly efficient method to monitor actions inside the subnets.

MID of RMON consists of 10 groups. The switch supports the most frequently used group 1, 2, 3 and 9:

- **Statistics:** Maintain basic usage and error statistics for each subnet monitored by the Agent.
- **History:** Record periodical statistic samples available from Statistics.
- **Alarm:** Allow management console users to set any count or integer for sample intervals and alert thresholds for RMON Agent records.
- **Event:** A list of all events generated by RMON Agent.

Alarm depends on the implementation of Event. Statistics and History display some current or history subnet statistics. Alarm and Event provide a method to monitor any integer data change in the network, and provide some alerts upon abnormal events (sending Trap or record in logs).

### 4.14.1 RMON Statistics

This page provides a Detail of a specific RMON statistics entry; RMON Statistics screen in [Figure 4-14-1](#) appears.

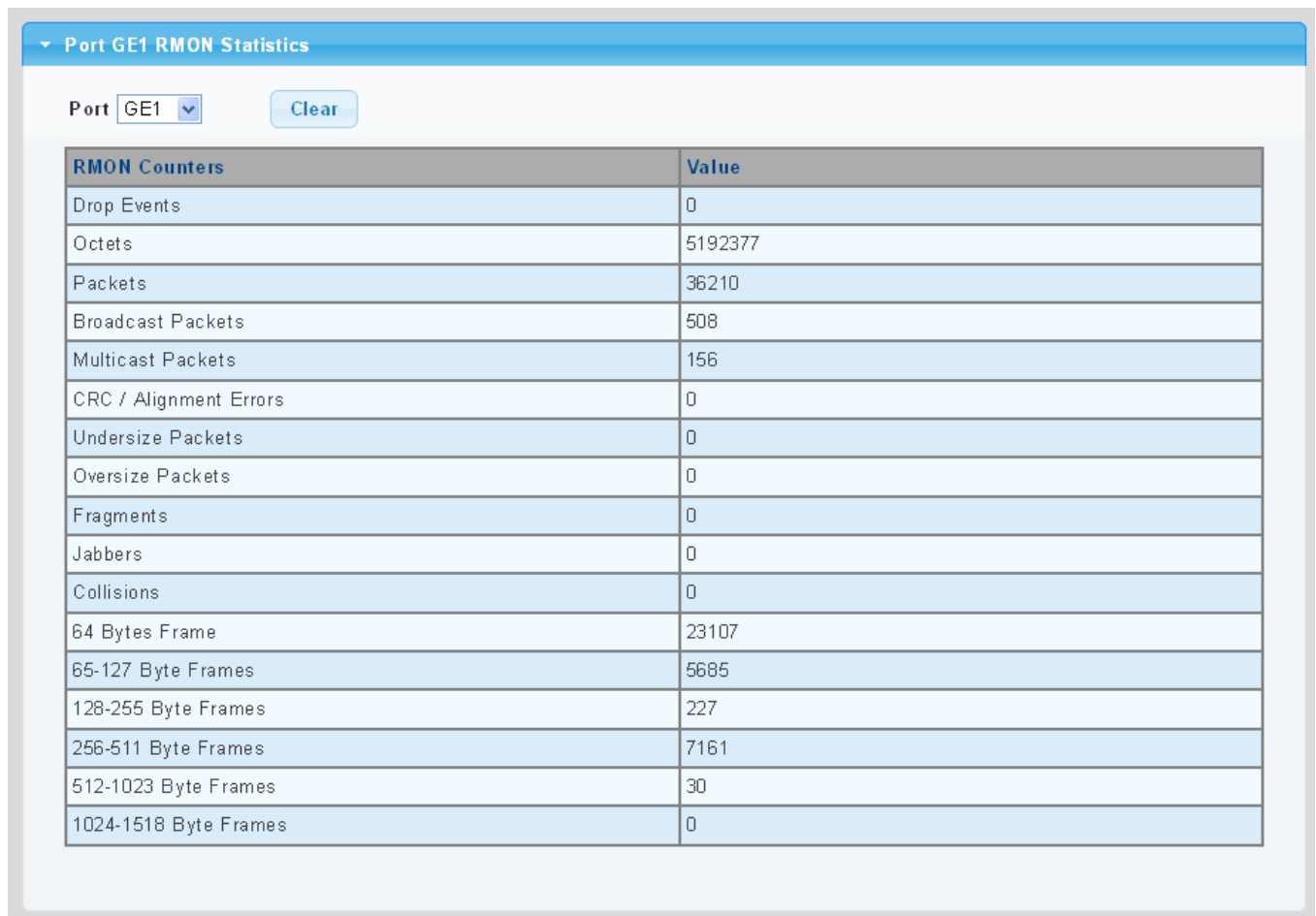

Port GE1

RMON Counters	Value
Drop Events	0
Octets	5192377
Packets	36210
Broadcast Packets	508
Multicast Packets	156
CRC / Alignment Errors	0
Undersize Packets	0
Oversize Packets	0
Fragments	0
Jabbers	0
Collisions	0
64 Bytes Frame	23107
65-127 Byte Frames	5685
128-255 Byte Frames	227
256-511 Byte Frames	7161
512-1023 Byte Frames	30
1024-1518 Byte Frames	0

Figure 4-14-1: RMON Statistics Detail Page Screenshot

The Page includes the following fields:

Object	Description
• Port	Select port from this drop-down list
• Drop Events	The total number of events in which packets were dropped by the probe due to lack of resources
• Octets	The total number of octets of data (including those in bad packets) received on the network
• Packets	The total number of packets (including bad packets, broadcast packets, and multicast packets) received
• Broadcast Packets	The total number of good packets received that were directed to the broadcast address
• Multicast Packets	The total number of good packets received that were directed to a multicast address
• CRC/Alignment Errors	The total number of packets received that had a length (excluding framing bits, but including FCS octets) of between 64 and 1518 octets
• Undersize Packets	The total number of packets received that were less than 64 octets
• Oversize Packets	The total number of packets received that were longer than 1518 octets
• Fragments	The number of frames which size is less than 64 octets received with invalid CRC
• Jabbers	The number of frames which size is larger than 64 octets received with invalid CRC
• Collisions	The best estimate of the total number of collisions on this Ethernet segment.
• 64 Bytes Frame	The total number of packets (including bad packets) received that were 64 octets in length
• 65~127 Byte Frames	The total number of packets (including bad packets) received that were between 65 to 127 octets in length
• 128~255 Byte Frames	The total number of packets (including bad packets) received that were between 128 to 255 octets in length
• 256~511 Byte Frames	The total number of packets (including bad packets) received that were between 256 to 511 octets in length
• 512~1023 Byte Frames	The total number of packets (including bad packets) received that were between 512 to 1023 octets in length
• 1024~1518 Byte Frames	The total number of packets (including bad packets) received that were between 1024 to 1518 octets in length

**Buttons**



: Click to clear the RMON statistics

### 4.14.2 RMON Event

Configure RMON Event table on this page. The RMON Event screens in [Figure 4-14-2](#) & [Figure 4-14-3](#) appear.

**RMON Event**

<b>Select Index</b>	<input type="text" value="Create New"/> ▼
<b>Index</b>	<input type="text" value="0"/> (1-65535)
<b>Type</b>	<input type="text" value="None"/> ▼
<b>Community</b>	<input type="text" value=""/>
<b>Owner</b>	<input type="text" value=""/> (0~31 Characters)
<b>Description</b>	<div style="border: 1px solid #ccc; height: 40px; width: 100%;"></div> (0~127 Characters)

**Figure 4-14-2:** RMON Event Configuration Page Screenshot

The page includes the following fields:

Object	Description
• <b>Select Index</b>	Select index from this drop-down list to create new index or modify index
• <b>Index</b>	Indicates the index of the entry. The range is from 1 to 65535
• <b>Type</b>	Indicates the notification of the event, the possible types are: <ul style="list-style-type: none"> <li>■ <b>none</b>: The total number of octets received on the interface, including framing characters.</li> <li>■ <b>log</b>: The number of uni-cast packets delivered to a higher-layer protocol.</li> <li>■ <b>SNMP-Trap</b>: The number of broad-cast and multi-cast packets delivered to a higher-layer protocol.</li> <li>■ <b>Log and Trap</b>: The number of inbound packets that are discarded even the packets are normal.</li> </ul>
• <b>Community</b>	Specify the community when trap is sent, the string length is from 0 to 127, default is "public".
• <b>Owner</b>	Indicates the owner of this event, the string length is from 0 to 127, default is a null string
• <b>Description</b>	Indicates description of this event, the string length is from 0 to 127, default is a null string

**Buttons**

: Click to apply changes.

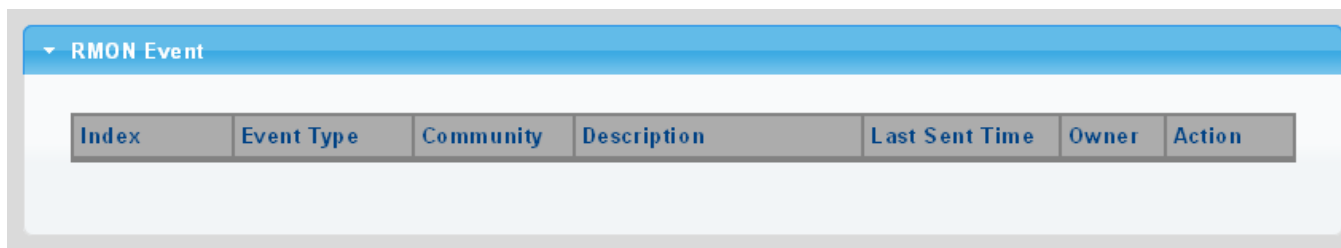



Figure 4-14-3: RMON Event Status Page Screenshot

The page includes the following fields:

Object	Description
• Index	Displays the current event index
• Event Type	Displays the current event type
• Community	Displays the current community for SNMP trap
• Description	Displays the current event description
• Last Sent Time	Displays the current last sent time
• Owner	Displays the current event owner
• Action	Click  to delete RMON event entry

### 4.14.3 RMON Event Log

This page provides an overview of RMON Event Log. The RMON Event Log Table screen in [Figure 4-14-4](#) appears.

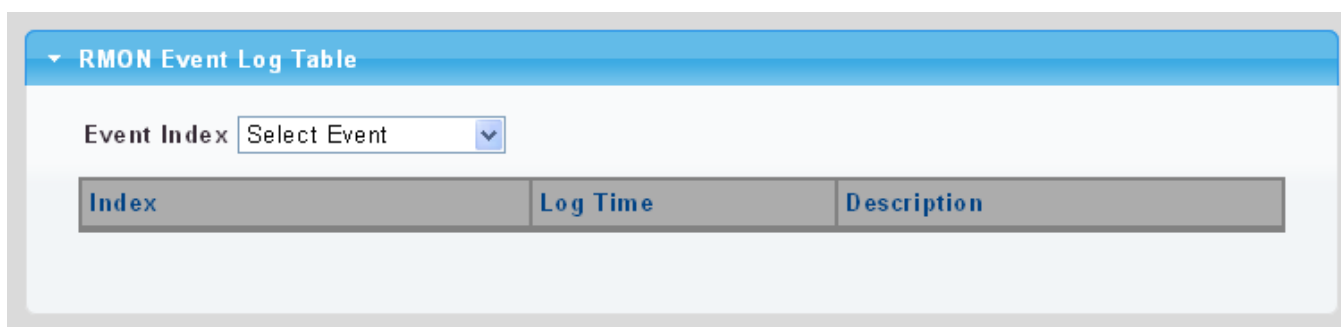

Figure 4-14-4: RMON Event Log Table Page Screenshot

The page includes the following fields:

Object	Description
• Select Index	Select index from this drop-down list
• Index	Indicates the index of the log entry
• Log Time	Indicates Event log time
• Description	Indicates the Event description



### 4.14.4 RMON Alarm

Configure RMON Alarm table on this page. The RMON Alarm screens in [Figure 4-14-5](#) & [Figure 4-14-6](#) appear.

**RMON Alarm**

<b>Select Index</b>	Create New <input type="button" value="v"/>
<b>Index</b>	<input type="text" value="0"/> (1-65535)
<b>Sample Port</b>	GE1 <input type="button" value="v"/>
<b>Sample Variable</b>	DropEvents <input type="button" value="v"/>
<b>Sample Interval</b>	<input type="text" value="0"/> (1-2147483647)
<b>Sample Type</b>	<input type="radio"/> absolute <input type="radio"/> delta
<b>Rising Threshold</b>	<input type="text" value="0"/> (0-2147483647)
<b>Falling Threshold</b>	<input type="text" value="0"/> (0-2147483647)
<b>Rising Event</b>	0: None (Unassigned) <input type="button" value="v"/>
<b>Falling Event</b>	0: None (Unassigned) <input type="button" value="v"/>
<b>Owner</b>	<input type="text"/> (0~31 Characters)

Figure 4-14-5: RMON Alarm Table Page Screenshot

The page includes the following fields:

Object	Description
• <b>Select Index</b>	Select index from this drop-down list to create the new index or modify the index
• <b>Index</b>	Indicates the index of the alarm entry
• <b>Sample Port</b>	Select port from this drop-down list
• <b>Sample Variable</b>	Indicates the particular variable to be sampled, the possible variables are: <ul style="list-style-type: none"> <li>■ <b>DropEvents</b>: The total number of events in which packets were dropped due to lack of resources.</li> <li>■ <b>Octets</b>: The number of received and transmitted (good and bad) bytes. Includes FCS, but excludes framing bits.</li> <li>■ <b>Pkts</b>: The total number of frames (bad, broadcast and multicast) received and transmitted.</li> <li>■ <b>BroadcastPkts</b>: The total number of good frames received that were directed to the broadcast address. Note that this does not include multicast packets.</li> <li>■ <b>MulticastPkts</b>: The total number of good frames received that were directed</li> </ul>

	<p>to this multicast address.</p> <ul style="list-style-type: none"> <li>■ <b>CRCAlignErrors</b>: The number of CRC/alignment errors (FCS or alignment errors).</li> <li>■ <b>UnderSizePkts</b>: The total number of frames received that were less than 64 octets long(excluding framing bits, but including FCS octets) and were otherwise well formed.</li> <li>■ <b>OverSizePkts</b>: The total number of frames received that were longer than 1518 octets(excluding framing bits, but including FCS octets) and were otherwise well formed.</li> <li>■ <b>Fragments</b>: The total number of frames received that were less than 64 octets in length (excluding framing bits, but including FCS octets) and had either an FCS or alignment error.</li> <li>■ <b>Jabbers</b>: The total number of frames received that were longer than 1518 octets (excluding framing bits, but including FCS octets), and had either an FCS or alignment error.</li> <li>■ <b>Collisions</b>: The best estimate of the total number of collisions on this Ethernet segment.</li> <li>■ <b>Pkts64Octets</b>: The total number of frames (including bad packets) received and transmitted that were 64 octets in length (excluding framing bits but including FCS octets).</li> <li>■ <b>Pkts64to172Octets</b>: The total number of frames (including bad packets) received and transmitted where the number of octets falls within the specified range (excluding framing bits but including FCS octets).</li> <li>■ <b>Pkts158to255Octets</b>: The total number of frames (including bad packets) received and transmitted where the number of octets falls within the specified range (excluding framing bits but including FCS octets).</li> <li>■ <b>Pkts256to511Octets</b>: The total number of frames (including bad packets) received and transmitted where the number of octets falls within the specified range (excluding framing bits but including FCS octets).</li> <li>■ <b>Pkts512to1023Octets</b>: The total number of frames (including bad packets) received and transmitted where the number of octets falls within the specified range (excluding framing bits but including FCS octets).</li> <li>■ <b>Pkts1024to1518Octets</b>: The total number of frames (including bad packets) received and transmitted where the number of octets falls within the specified range (excluding framing bits but including FCS octets).</li> </ul>
<ul style="list-style-type: none"> <li>• <b>Sample Interval</b></li> </ul>	<p>Sample interval (1–2147483647)</p>
<ul style="list-style-type: none"> <li>• <b>Sample Type</b></li> </ul>	<p>The method of sampling the selected variable and calculating the value to be compared against the thresholds, possible sample types are:</p> <ul style="list-style-type: none"> <li>■ <b>Absolute</b>: Get the sample directly (default).</li> <li>■ <b>Delta</b>: Calculate the difference between samples.</li> </ul>

• <b>Rising Threshold</b>	Rising threshold value (0–2147483647)
• <b>Falling Threshold</b>	Falling threshold value (0–2147483647)
• <b>Rising Event</b>	Event to fire when the rising threshold is crossed
• <b>Falling Event</b>	Event to fire when the falling threshold is crossed
• <b>Owner</b>	Specify an owner for the alarm

**Buttons**

: Click to apply changes.

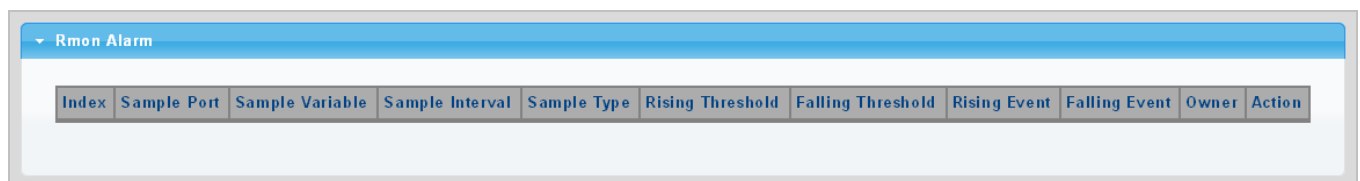

**Figure 4-14-6:** RMON Alarm Status Page Screenshot

The page includes the following fields:

Object	Description
• <b>Index</b>	Indicates the index of Alarm control entry
• <b>Sample Port</b>	Displays the current sample port
• <b>Sample Variable</b>	Displays the current sample variable
• <b>Sample Interval</b>	Displays the current interval
• <b>Sample Type</b>	Displays the current sample type
• <b>Rising Threshold</b>	Displays the current rising threshold
• <b>Falling Threshold</b>	Displays the current falling threshold
• <b>Rising Event</b>	Displays the current rising event
• <b>Falling Event</b>	Displays the current falling event
• <b>Owner</b>	Displays the current owner
• <b>Action</b>	Click  to delete RMON alarm entry

### 4.14.5 RMON History

Configure RMON History table on this page. The RMON History screens in [Figure 4-14-7](#) & [Figure 4-14-8](#) appear.

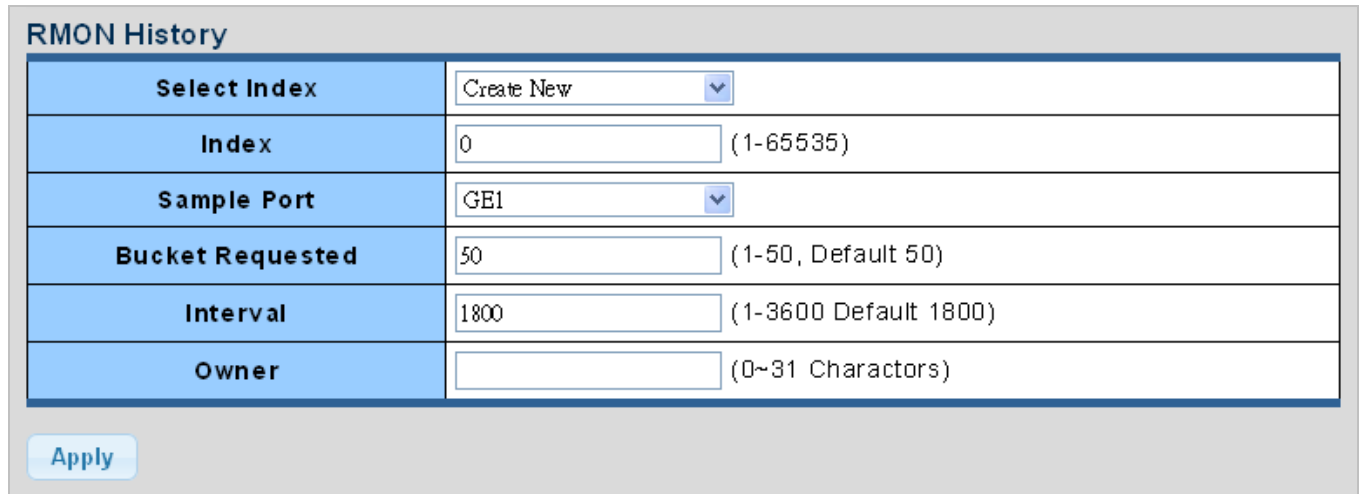

RMON History	
Select Index	Create New <input type="button" value="v"/>
Index	0 <input type="text"/> (1-65535)
Sample Port	GE1 <input type="button" value="v"/>
Bucket Requested	50 <input type="text"/> (1-50, Default 50)
Interval	1800 <input type="text"/> (1-3600 Default 1800)
Owner	<input type="text"/> (0~31 Charactors)

Figure 4-14-7: RMON History Table Page Screenshot

The page includes the following fields:

Object	Description
• Select Index	Select index from this drop-down list to create the new index or modify the index
• Index	Indicates the index of the history entry
• Sample Port	Select port from this drop-down list
• Bucket Requested	Indicates the maximum data entries associated this History control entry stored in RMON. The range is from 1 to 50, default value is 50
• Interval	Indicates the interval in seconds for sampling the history statistics data. The range is from 1 to 3600, default value is 1800 seconds.
• Owner	Specify an owner for the history

#### Buttons

: Click to apply changes.

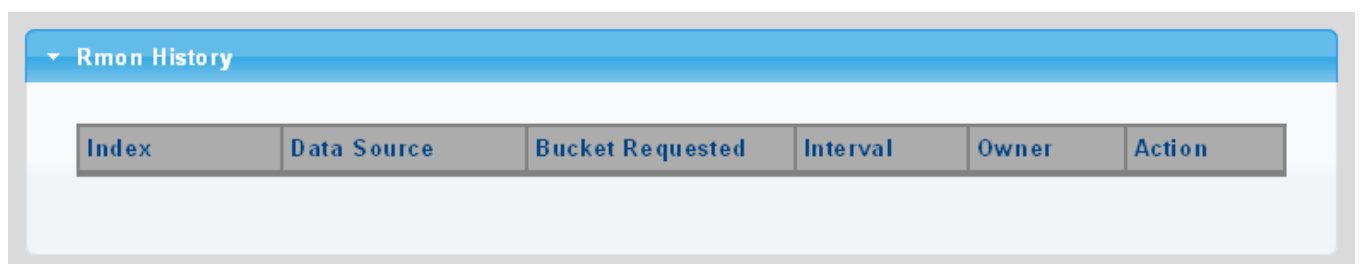

Rmon History					
Index	Data Source	Bucket Requested	Interval	Owner	Action

Figure 4-14-8: RMON History Status Page Screenshot

The page includes the following fields:

Object	Description
• Index	Displays the current index
• Data Source	Displays the current data source
• Bucket Requested	Displays the current bucket requested
• Interval	Displays the current interval
• Owner	Displays the current owner
• Action	Click  to delete RMON history entry.

#### 4.14.6 RMON History Log

This page provides a detail of RMON history entries; screen in [Figure 4-14-9](#) appears.

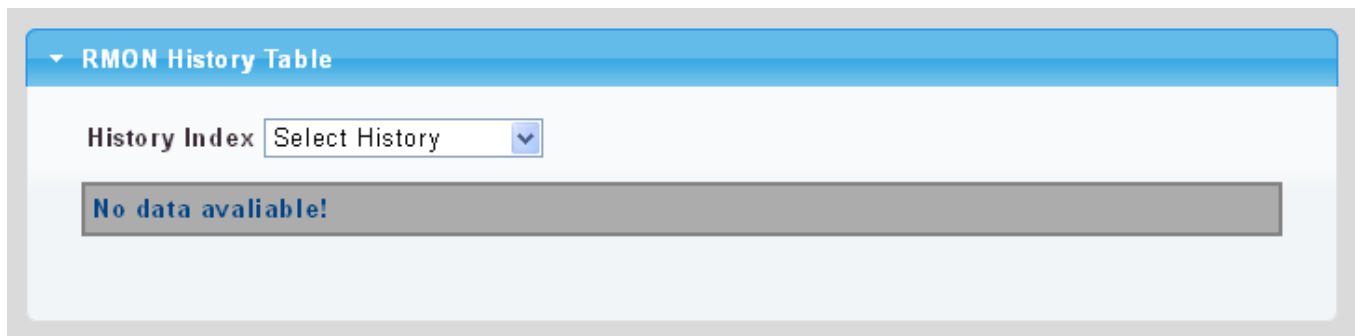

Figure 4-14-9: RMON History Status Page Screenshot

The page includes the following fields:

Object	Description
• History Index	Select history index from this drop-down list

#### Buttons

: Click to apply changes.

## 4.15 Power over Ethernet

The IGS-4215 PoE Switch Series can easily build a power central-controlled IP phone system, IP camera system and AP group for the enterprise. For instance, cameras / APs can be easily installed around the corner in the company for surveillance demands or build a wireless roaming environment in the office. Without the power-socket limitation, the IGS-4215 PoE Switch Series makes the installation of cameras or WLAN APs easier and more efficient.

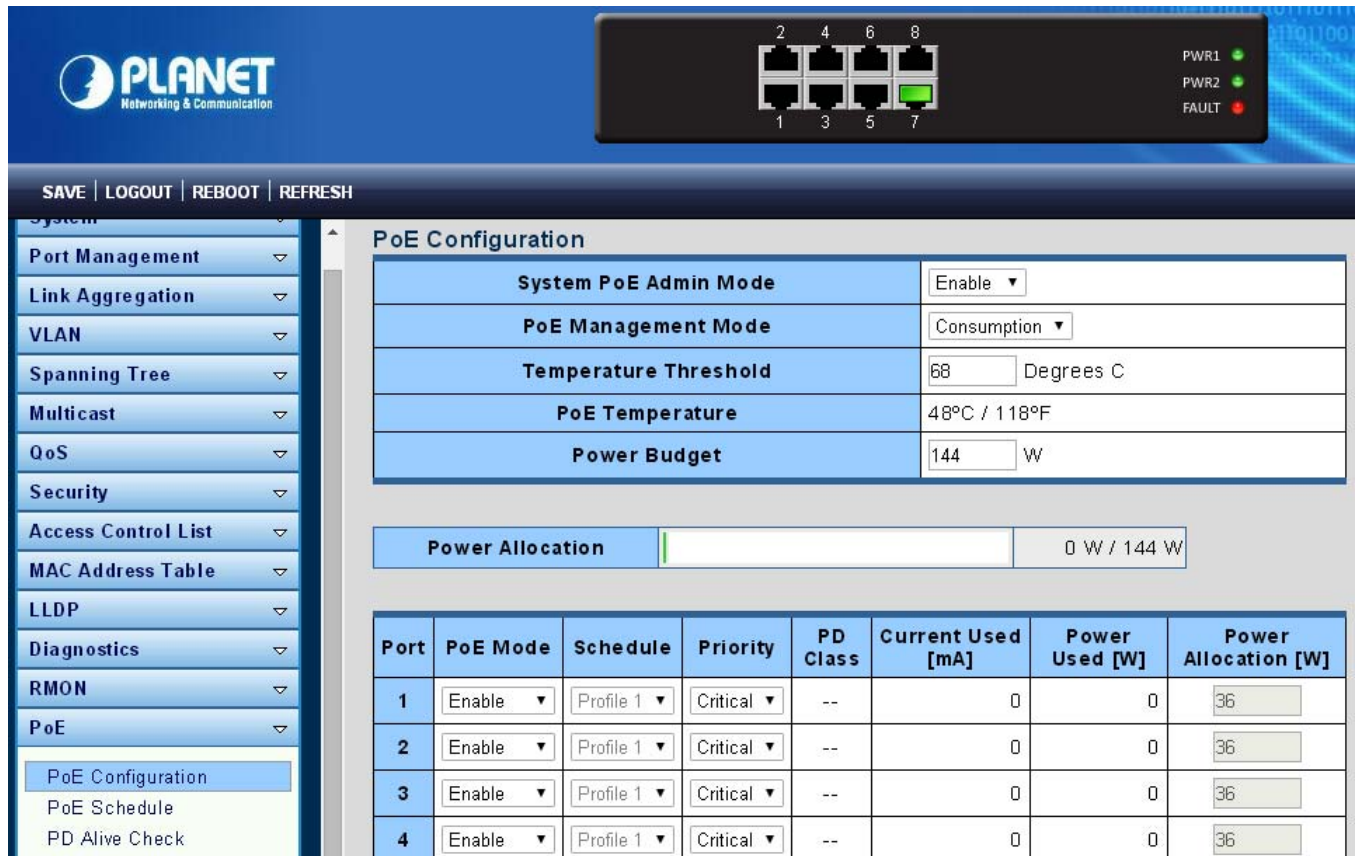







The screenshot shows the web management interface for the PLANET IGS-4215 PoE Switch. At the top, there is a physical switch image with ports 1-8 and status LEDs for PWR1, PWR2, and FAULT. Below the navigation menu, the 'PoE Configuration' page is displayed. It includes a 'System PoE Admin Mode' set to 'Enable', 'PoE Management Mode' set to 'Consumption', a 'Temperature Threshold' of 68 Degrees C, 'PoE Temperature' of 48°C / 118°F, and a 'Power Budget' of 144 W. A 'Power Allocation' bar shows 0 W / 144 W. A table below lists the status for ports 1 through 4.

Port	PoE Mode	Schedule	Priority	PD Class	Current Used [mA]	Power Used [W]	Power Allocation [W]
1	Enable	Profile 1	Critical	--	0	0	36
2	Enable	Profile 1	Critical	--	0	0	36
3	Enable	Profile 1	Critical	--	0	0	36
4	Enable	Profile 1	Critical	--	0	0	36

Figure 4-16-1: Power over Ethernet Status

### 4.15.1 Power over Ethernet Powered Device

 <p><b>3~5 watts</b></p>	<p><b>Voice over IP phones</b></p> <p>Enterprise can install POE VoIP Phone, ATA and other Ethernet/non-Ethernet end-devices in the central area where UPS is installed for un-interruptible power system and power control system.</p>
 <p><b>6~12 watts</b></p>	<p><b>Wireless LAN Access Points</b></p> <p>Museums, sightseeing spots, airports, hotels, campuses, factories, and warehouses can install the Access Point anywhere.</p>

 <p><b>10~12 watts</b></p>	<p><b>IP Surveillance</b></p> <p>Enterprises, museums, campuses, hospitals and banks can install IP camera without the limit of the installation location. Electrician is not needed to install AC sockets.</p>
 <p><b>3~12 watts</b></p>	<p><b>PoE Splitter</b></p> <p>PoE Splitter splits the PoE 56V DC over the Ethernet cable into 5/12V DC power output. It frees the device deployment from restrictions due to power outlet locations, which eliminate the costs for additional AC wiring and reduces the installation time.</p>
 <p><b>3~25 watts</b></p>	<p><b>High Power PoE Splitter</b></p> <p>High PoE Splitter splits the PoE 56V DC over the Ethernet cable into 24/12V DC power output. It frees the device deployment from restrictions due to power outlet locations, which eliminate the costs for additional AC wiring and reduces the installation time.</p>
 <p><b>30 watts</b></p>	<p><b>High Power Speed Dome</b></p> <p>This state-of-the-art design is considerable to fit in various network environments like traffic centers, shopping malls, railway stations, warehouses, airports, and production facilities for the most demanding outdoor surveillance applications. Electrician is not needed to install AC sockets.</p>



Since the IGS-4215 PoE Switch Series per PoE port supports 56V DC PoE power output, please check and assure the Powered Device's (PD) acceptable DC power range is 56V DC; otherwise, it will damage the Powered Device (PD).

### 4.15.2 System Configuration

In a power over Ethernet system, operating power is applied from a power source (PSU-power supply unit) over the LAN infrastructure to **powered devices (PDs)**, which are connected to ports. Under some conditions, the total output power required by PDs can exceed the maximum available power provided by the PSU. The system with a PSU is capable of supplying less power than the total potential power consumption of all the PoE ports in the system. In order to maintain the function of the majority of the ports, power management is implemented.

The PSU input power consumption is monitored by measuring voltage and current .The input power consumption is equal to the system's aggregated power consumption .The power management concept allows all ports to be active and activates additional ports, as long as the aggregated power of the system is lower than the power level at which additional PDs cannot be connected .When this value is exceeded, ports will be deactivated, according to user-defined priorities. The power budget is managed according to the following user-definable parameters: maximum available power, ports priority and maximum allowable power per port.

#### Reserved Power

There are five modes for configuring how the ports/PDs may reserve power and when to shut down ports.

#### ■ Classification mode

In this mode each port automatic determines how much power to reserve according to the class the connected PD belongs to, and reserves the power accordingly. Four different port classes exist and one for 4, 7, 15.4 and 30.8 watts.

Class	Usage	Range of maximum power used by the PD	Class Description
0	Default	0.44 to 12.95 watts	Classification unimplement
1	Optional	0.44 to 3.84 watts	Very low power
2	Optional	3.84 to 6.49 watts	Low power
3	Optional	6.49 to 12.95 watts (or to 15.4 watts)	Mid power
4	Optional	12.95 to 25.50 watts (or to 30.8 watts)	High power

**Table 4-16-1:** Standard PoE Parameters and Comparison



1. In this mode the **Maximum Power fields** have no effect.
2. The PoE chip of PD69008 / PD69012 designed to that Class level 0 will be assigned to 15.4 watts in AF mode and 30.8 watts in AT mode under classification power limit mode. It is hardware limited.

#### ■ Allocation mode

In this mode, the user allocates the amount of power that each port may reserve. The allocated/reserved power for each port/PD is specified in the Maximum Power fields. The ports are shut down when total reserved power exceeds the amount of power that the power supply can deliver.





In this mode, the port power is not turned on if the PD requests more available power.

### 4.15.3 Power over Ethernet Configuration

This section allows the user to inspect and configure the current PoE configuration setting as screen in [Figure 4-16-1](#) appears.

PoE Configuration	
System PoE Admin Mode	Enable ▾
PoE Management Mode	Consumption ▾
Temperature Threshold	68 Degrees C
PoE Temperature	48°C / 118°F
Power Budget	144 W

Figure 4-16-1: PoE Configuration Screenshot

The page includes the following fields:

Object	Description
• System PoE Admin Mode	Allows user to enable or disable PoE function. It will cause all of PoE ports to supply or not to supply power.
• PoE Management Mode	<p>There are six modes for configuring how the ports/PDs may reserve power and when to shut down ports.</p> <ul style="list-style-type: none"> <li>■ <b>Classification mode:</b> The system reserves PoE power to PD according to PoE class level.</li> <li>■ <b>Consumption mode:</b> The system offers PoE power according to PD real power consumption.</li> <li>■ <b>Allocation mode:</b> Users allow to assign how much PoE power to each port and the system will reserve PoE power to PD.</li> </ul>
• Temperature Threshold	Allows setting over temperature protection threshold value. If the system temperature is overly high, the system will lower the total PoE power budget automatically.
• PoE Temperature	Display the PoE Chip Temperature
• Power Budget	Configure PoE power output budget

This section displays the **PoE Power Usage** of Current Power Consumption as [Figure 4-16-2](#) shows.

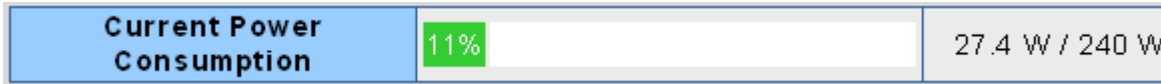

**Figure 4-16-2:** Current Power Consumption Screenshot

This section allows the user to inspect and configure the current PoE port settings as [Figure 4-16-3](#) shows.

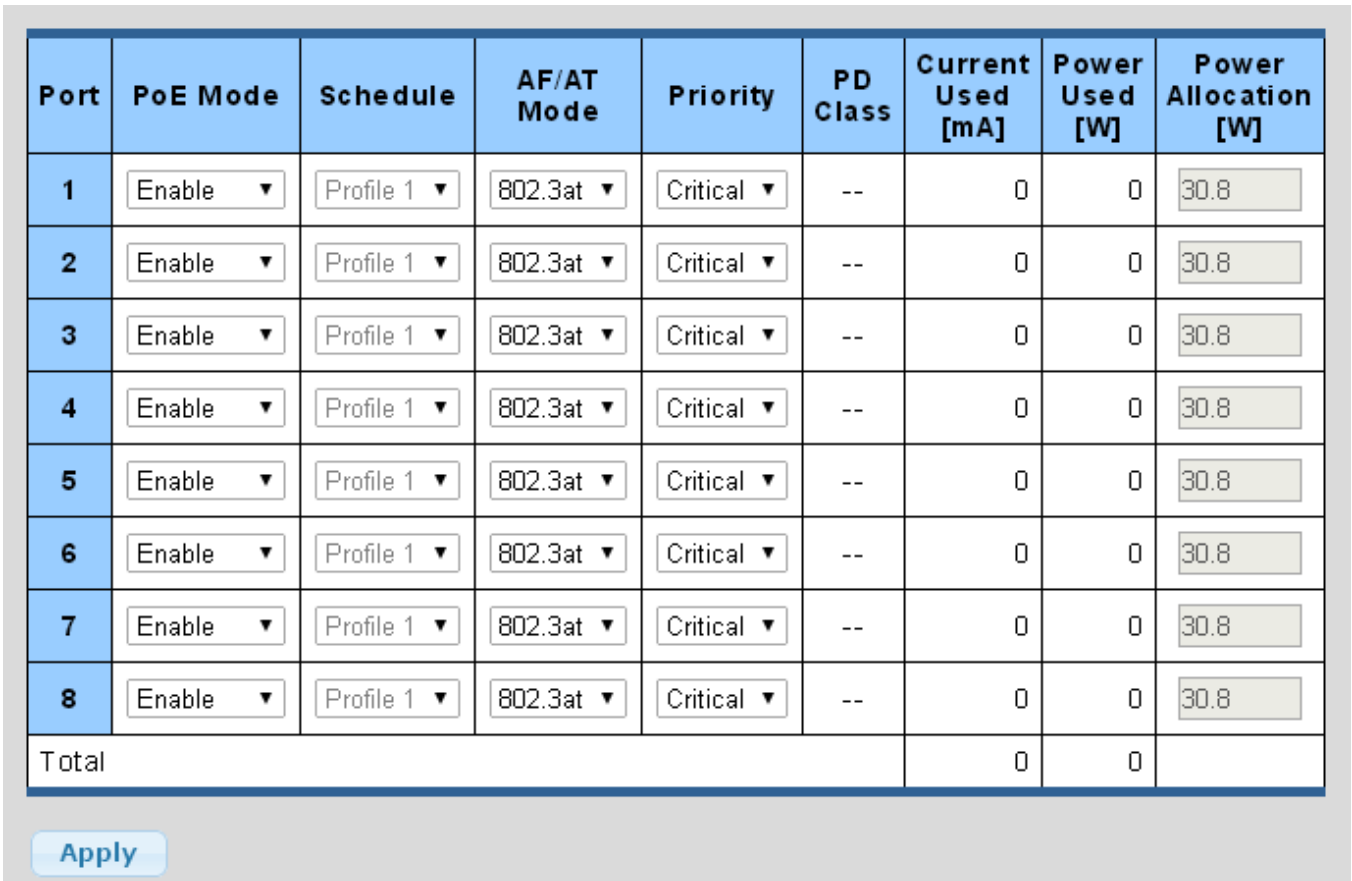

**Figure 4-16-3:** Power over Ethernet Configuration Screenshot

The page includes the following fields:

Object	Description
<ul style="list-style-type: none"> <li>• <b>PoE Mode</b></li> </ul>	<p>There are three modes for PoE mode.</p> <ul style="list-style-type: none"> <li>■ <b>Enable:</b> enable PoE function..</li> <li>■ <b>Disable:</b> disable PoE function.</li> <li>■ <b>Schedule:</b> enable PoE function in schedule mode.</li> </ul>
<ul style="list-style-type: none"> <li>• <b>Schedule</b></li> </ul>	<p>Indicates the scheduled profile mode. Possible profiles are:</p> <ul style="list-style-type: none"> <li>■ <b>Profile1</b></li> <li>■ <b>Profile2</b></li> <li>■ <b>Profile3</b></li> </ul>

■ Profile4	
<ul style="list-style-type: none"> <li>• <b>AF/AT Mode</b></li> </ul>	<p>Allows user to select 802.3at or 802.3af compatibility mode. The default value is 802.3at mode.</p> <p>This function will affect PoE power reservation in Classification power limit mode only, as <b>802.3af mode</b>, the system is going to reserve a maximum of <b>15.4W</b> for PD that supports Class3 level. As IEEE <b>802.3at mode</b>, the system is going to reserve <b>30.8 watts</b> for PD that supports Class4 level.</p> <p>From class1 to class3 level in the 802.3at mode, it will reserve the same PoE power as in 802.3af mode.</p>
<ul style="list-style-type: none"> <li>• <b>Priority</b></li> </ul>	<p>The Priority represents PoE ports priority. There are three levels of power priority named <b>Low</b>, <b>High</b> and <b>Critical</b>.</p> <p>The priority is used in case the total power consumption is over the total power budget. In this case the port with the lowest priority will be turned off, and offer power for the port of higher priority.</p>
<ul style="list-style-type: none"> <li>• <b>PD Class</b></li> </ul>	<p>Displays the class of the PD attached to the port, as established by the classification process. Class 0 is the default for PDs. The PD is powered based on PoE Class level if the system is working in Classification mode. The PD will return to Class 0 to 4 in accordance with the maximum power draw as specified by <a href="#">Table 4-16-1</a>.</p>
<ul style="list-style-type: none"> <li>• <b>Current Used [mA]</b></li> </ul>	<p>The <b>Power Used</b> shows how much current the PD currently is using.</p>
<ul style="list-style-type: none"> <li>• <b>Power Used [W]</b></li> </ul>	<p>The <b>Power Used</b> shows how much power the PD currently is using.</p>
<ul style="list-style-type: none"> <li>• <b>Power Allocation</b></li> </ul>	<p>It can limit the port PoE supply watts. Per port maximum value must be less than <b>30.8 watts</b>. Total port values must be less than the Power Reservation value. Once power overload is detected, the port will auto shut down and keep in detection mode until PD's power consumption is lower than the power limit value</p>

**Buttons**



: Click to apply changes.

### 4.15.4 PoE Schedule

This page allows the user to define PoE schedule and scheduled power recycling.

#### PoE Schedule

Besides being used as an IP Surveillance, the Managed PoE switch is certainly applicable to construct any PoE network including VoIP and Wireless LAN. Under the trend of energy saving worldwide and contributing to the environmental protection on the Earth, the Managed PoE switch can effectively control the power supply besides its capability of giving high watts power. The **"PoE schedule"** function helps you to enable or disable PoE power feeding for each PoE port during specified time intervals and it is a powerful function to help SMB or Enterprise saving power and money.

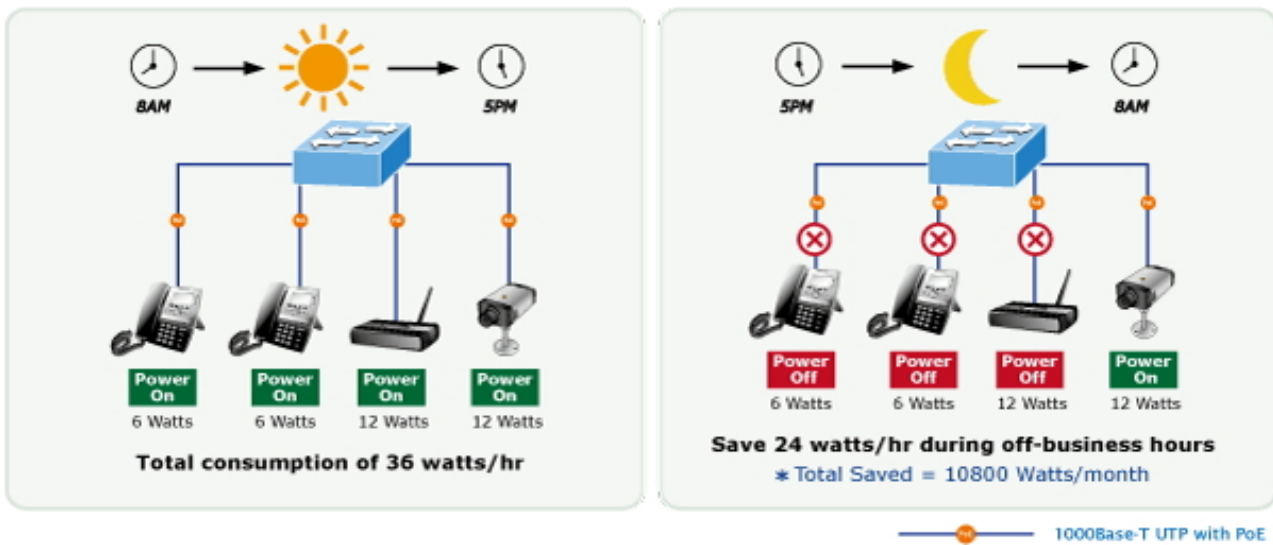

#### Scheduled Power Recycling

The Managed PoE switch allows each of the connected PoE IP cameras to reboot at a specified time each week. Therefore, it will reduce the chance of IP camera crash resulting from buffer overflow.

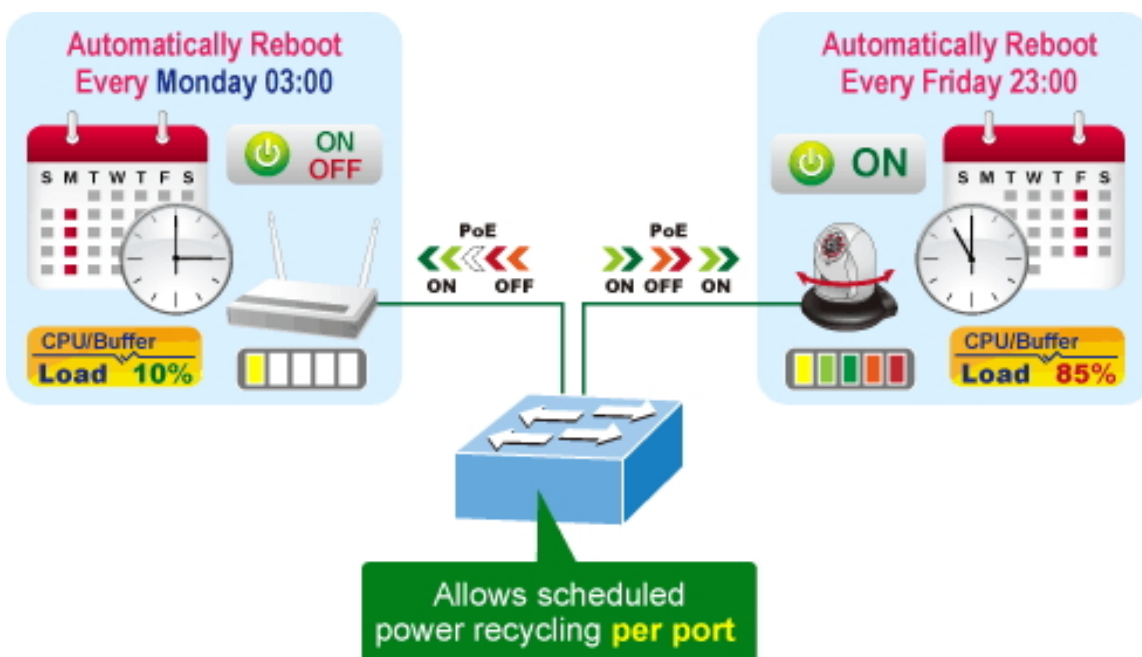

The screen in Figure 4-16-4 appears.

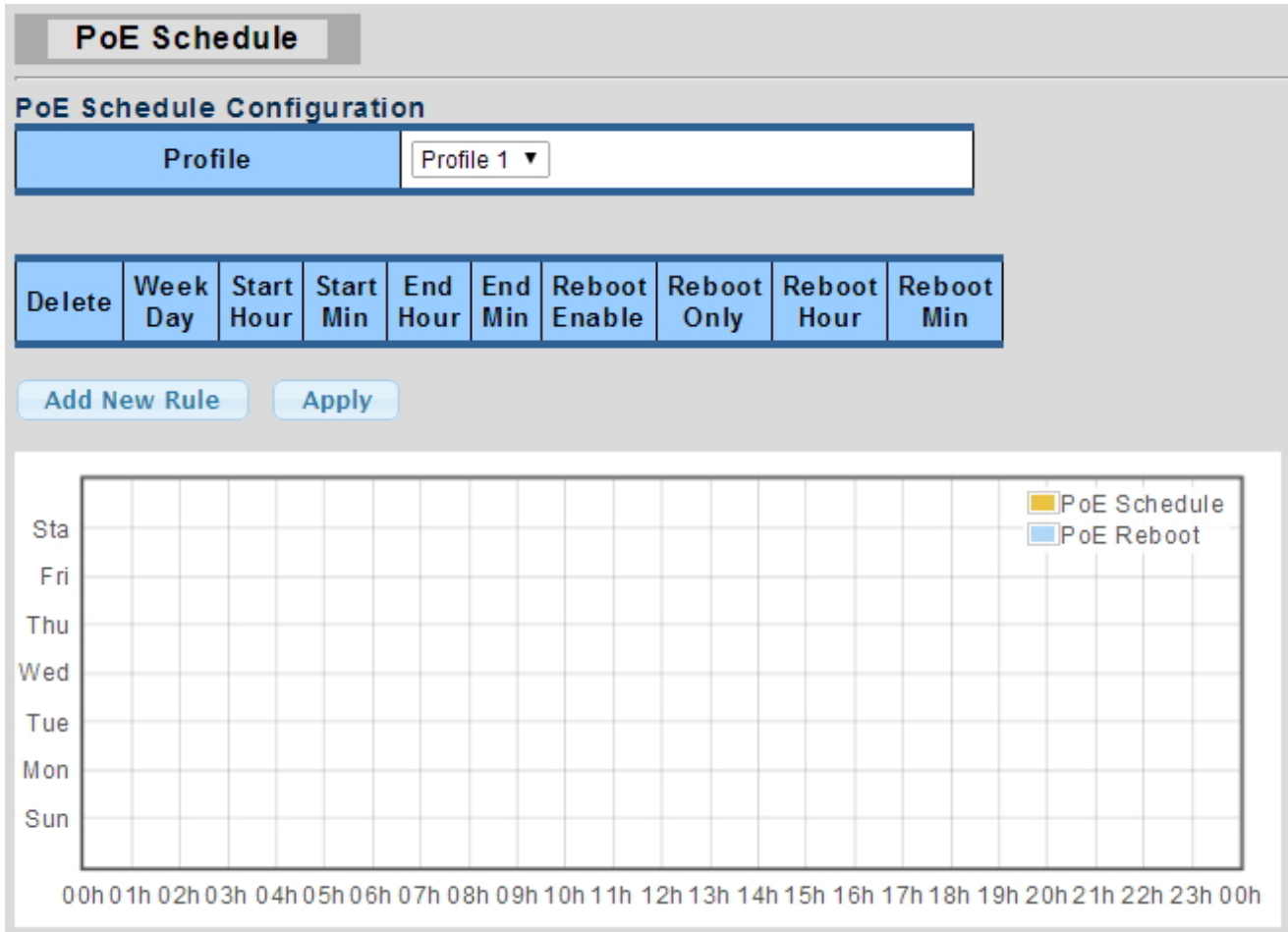

Figure 4-16-4: PoE Schedule Screenshot

Please press the **Add New Rule** button to start setting PoE Schedule function. You have to set PoE schedule to profile and then go back to PoE Port Configuration, and select **"Schedule"** mode from per port **"PoE Mode"** option to enable you to indicate which schedule profile could be applied to the PoE port.

The page includes the following fields:

Object	Description
<ul style="list-style-type: none"> <li><b>Profile</b></li> </ul>	Set the schedule profile mode. Possible profiles are: <b>Profile1</b> <b>Profile2</b> <b>Profile3</b> <b>Profile4</b>
<ul style="list-style-type: none"> <li><b>Week Day</b></li> </ul>	Allows user to set week day for defining PoE function by enabling it on the day.
<ul style="list-style-type: none"> <li><b>Start Hour</b></li> </ul>	Allows user to set what hour PoE function does by enabling it.
<ul style="list-style-type: none"> <li><b>Start Min</b></li> </ul>	Allows user to set what minute PoE function does by enabling it.

• <b>End Hour</b>	Allows user to set what hour PoE function does by disabling it.
• <b>End Min</b>	Allows user to set what minute PoE function does by disabling it.
• <b>Reboot Enable</b>	Allows user to enable or disable the whole PoE port reboot by PoE reboot schedule. Please note that if you want PoE schedule and PoE reboot schedule to work at the same time, please use this function, and don't use <b>Reboot Only</b> function. This function offers administrator to reboot PoE device at an indicated time if administrator has this kind of requirement.
• <b>Reboot Only</b>	Allows user to reboot PoE function by PoE reboot schedule. Please note that if administrator enables this function, PoE schedule will not set time to profile. This function is just for PoE port to reset at an indicated time.
• <b>Reboot Hour</b>	Allows user to set what hour PoE reboots. This function is only for PoE reboot schedule.
• <b>Reboot Min</b>	Allows user to set what minute PoE reboots. This function is only for PoE reboot schedule.

**Buttons**

: Click to add new rule.

: Click to apply changes

: Check to delete the entry.

### 4.15.5 PoE Alive Check Configuration

The IGS-4215 PoE Switch Series can be configured to monitor connected PD's status in real-time via ping action. Once the PD stops working and without response, the PoE Switch is going to restart PoE port power, and bring the PD back to work. It will greatly enhance the reliability and reduces administrator management burden.

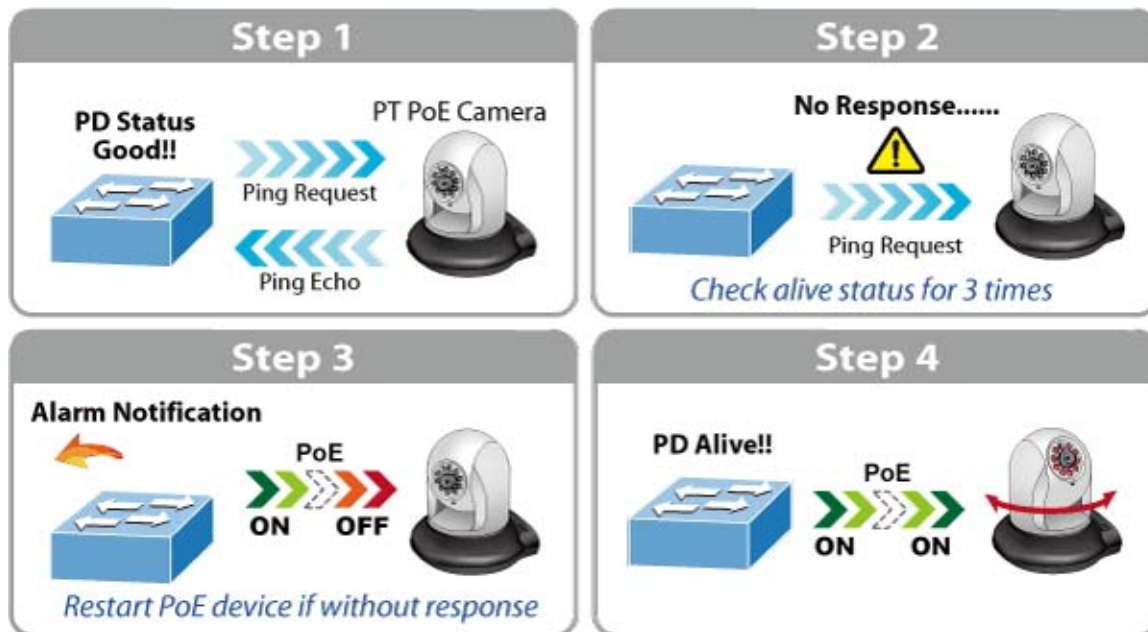

This page provides you with how to configure PD Alive Check. The screen in Figure 4-16-5 appears.

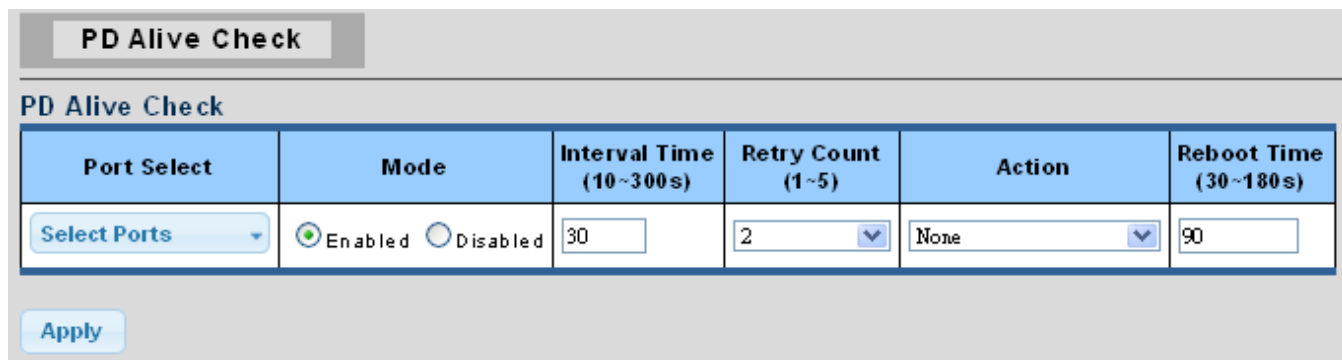

Figure 4-15-5: PD Alive Check Configuration Screenshot

The page includes the following fields:

Object	Description
<ul style="list-style-type: none"> <li>• <b>Mode</b></li> </ul>	<p>Allows user to enable or disable per port PD Alive Check function.</p> <p>By default, all ports are disabled.</p>
<ul style="list-style-type: none"> <li>• <b>Ping PD IP Address</b></li> </ul>	<p>This column allows user to set PoE device IP address for system making ping to the PoE device. Please note that the PD's IP address must be set to the same network segment with the PoE Switch.</p>

<ul style="list-style-type: none"> <li>• <b>Interval Time (10~300s)</b></li> </ul>	<p>This column allows user to set how long system should issue a ping request to PD for detecting whether PD is alive or dead.</p> <p>Interval time range is from 10 seconds to 300 seconds.</p>
<ul style="list-style-type: none"> <li>• <b>Retry Count (1~5)</b></li> </ul>	<p>This column allows user to set the number of times system retries ping to PD.</p> <p>For example, if we set count 2, it means that if system retries ping to the PD and the PD doesn't response continuously, the PoE port will be reset.</p>
<ul style="list-style-type: none"> <li>• <b>Action</b></li> </ul>	<p>Allows user to set which action will be applied if the PD is without any response. The PoE Switch Series offers the following 3 actions:</p> <ul style="list-style-type: none"> <li>■ <b>PD Reboot:</b> It means system will reset the PoE port that is connected to the PD.</li> <li>■ <b>PD Reboot &amp; Alarm:</b> It means system will reset the PoE port and issue an alarm message via Syslog.</li> <li>■ <b>Alarm:</b> It means system will issue an alarm message via Syslog.</li> </ul>
<ul style="list-style-type: none"> <li>• <b>Reboot Time (30~180s)</b></li> </ul>	<p>This column allows user to set the PoE device rebooting time as there are so many kinds of PoE devices on the market and they have a different rebooting time.</p> <p>The PD Alive-check is not a defining standard, so the PoE device on the market doesn't report reboot done information to the PoE Switch. Thus, user has to make sure how long the PD will take to finish booting, and then set the time value to this column.</p> <p>System is going to check the PD again according to the reboot time. If you are not sure of the precise booting time, we suggest you set it longer.</p>

**Buttons**

: Click to apply changes.

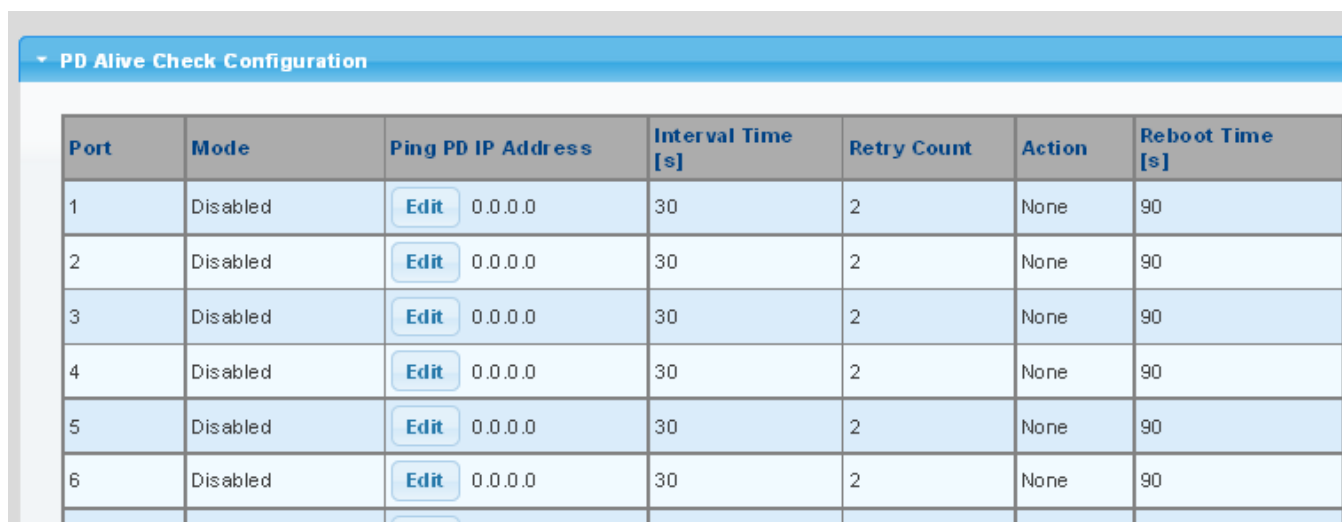

Port	Mode	Ping PD IP Address	Interval Time [s]	Retry Count	Action	Reboot Time [s]
1	Disabled	<a href="#">Edit</a> 0.0.0.0	30	2	None	90
2	Disabled	<a href="#">Edit</a> 0.0.0.0	30	2	None	90
3	Disabled	<a href="#">Edit</a> 0.0.0.0	30	2	None	90
4	Disabled	<a href="#">Edit</a> 0.0.0.0	30	2	None	90
5	Disabled	<a href="#">Edit</a> 0.0.0.0	30	2	None	90
6	Disabled	<a href="#">Edit</a> 0.0.0.0	30	2	None	90

Figure 4-15-6: PD Alive Check Configuration Screenshot



## 4.16 Maintenance

Use the Maintenance menu items to display and configure basic configurations of the Industrial Managed Switch. Under maintenance, the following topics are provided to back up, upgrade, save and restore the configuration. This section has the following items:

- **Factory Default** You can reset the configuration of the switch on this page.
- **Reboot Switch** You can restart the switch on this page. After restart, the switch will boot normally.
- **Backup Manager** You can back up the switch configuration.
- **Upgrade Manager** You can upgrade the switch configuration.
- **Dual Image** Select active or backup image on this page.

### 4.16.1 Factory Default

You can reset the configuration of the switch on this page. Only the IP configuration is retained. The new configuration is available immediately, which means that no restart is necessary. The Factory Default screen in [Figure 4-15-1](#) appears and click to reset the configuration to Factory Defaults.

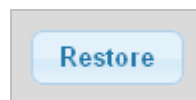

Figure 4-15-1 Factory Default Page Screenshot

After the “**Factory**” button is pressed and rebooted, the system will load the default IP settings as follows:

- Default IP address: **192.168.0.100**
- Subnet mask: **255.255.255.0**
- Default Gateway: **192.168.0.254**
- The other setting value is back to disable or none.



---

To reset the Industrial Managed Switch to the Factory default setting, you can also press the hardware reset button on the front panel for about 10 seconds. After the device is rebooted, you can login the management Web interface within the same subnet of 192.168.0.xx.

---

### 4.16.2 Reboot Switch

The **Reboot** page enables the device to be rebooted from a remote location. Once the Reboot button is pressed, user has to re-login the Web interface for about 60 seconds. The Reboot Switch screen in [Figure 4-16-2](#) appears and click to reboot the system.



Figure 4-16-2 Reboot Switch Page Screenshot

### 4.16.3 Backup Manager

This function allows backup of the current image or configuration of the Industrial Managed Switch to the local management station. The Backup Manager screen in [Figure 4-16-3](#) appears.

#### Backup Manager

<b>Backup Method</b>	TFTP <span style="float: right;">▼</span>
<b>Server IP</b>	<input style="width: 80%;" type="text"/> (IPv4 or IPv6 Address)
<b>Backup Type</b>	<input checked="" type="radio"/> Image <input type="radio"/> Running configuration <input type="radio"/> Startup configuration <input type="radio"/> Backup configuration <input type="radio"/> Flash log <input type="radio"/> Buffered log
<b>Image</b>	<input checked="" type="radio"/> vmlinux_poe_test.bix (Active) <input type="radio"/> vmlinux_poe_test.bix (Backup)

**Figure 4-16-3** Backup Manager Page Screenshot

The page includes the following fields:

Object	Description
• <b>Backup Method</b>	Select backup method from this drop-down list.
• <b>Server IP</b>	Fill in your TFTP server IP address.
• <b>Backup Type</b>	Select backup type.
• <b>Image</b>	Select active or backup image.

#### Buttons

: Click to back up image, configuration or log.

### 4.16.4 Upgrade Manager

This function allows reloading of the current image or configuration of the Industrial Managed Switch to the local management station. The Upgrade Manager screen in [Figure 4-16-4](#) appears.

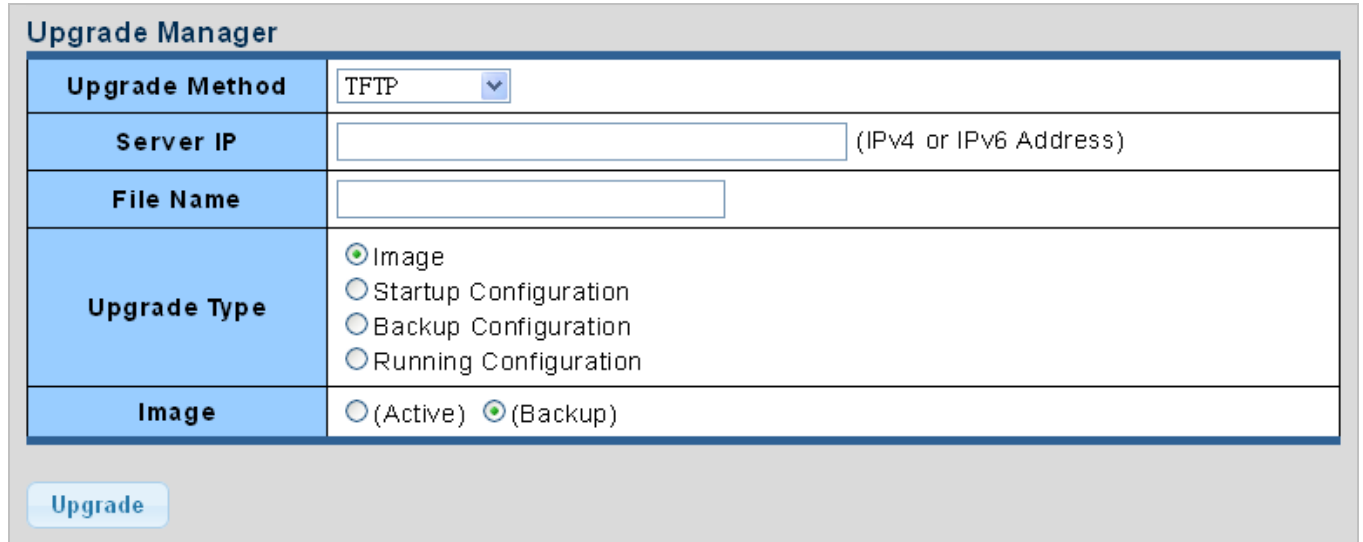

Upgrade Manager	
Upgrade Method	TFTP
Server IP	<input type="text"/> (IPv4 or IPv6 Address)
File Name	<input type="text"/>
Upgrade Type	<input checked="" type="radio"/> Image <input type="radio"/> Startup Configuration <input type="radio"/> Backup Configuration <input type="radio"/> Running Configuration
Image	<input type="radio"/> (Active) <input checked="" type="radio"/> (Backup)

Figure 4-16-4 Upgrade Manager Page Screenshot

The page includes the following fields:

Object	Description
• Upgrade Method	Select upgrade method from this drop-down list.
• Server IP	Fill in your TFTP server IP address.
• File Name	The name of firmware image or configuration.
• Upgrade Type	Select upgrade type.
• Image	Select active or backup image.

#### Buttons

: Click to upgrade image or configuration.

### 4.16.5 Dual Image

This page provides information about the active and backup firmware images in the device, and allows you to revert to the backup image. The web page displays two tables with information about the active and backup firmware images. The Dual Image Configuration and Information screens in [Figure 4-16-5](#) & [Figure 4-16-6](#) appear.



**Figure 4-15-5:** Dual Image Configuration Page Screenshot

The page includes the following fields:

Object	Description
<ul style="list-style-type: none"> <li>Active Image</li> </ul>	Select the active or backup image

#### Buttons

: Click to apply active image.

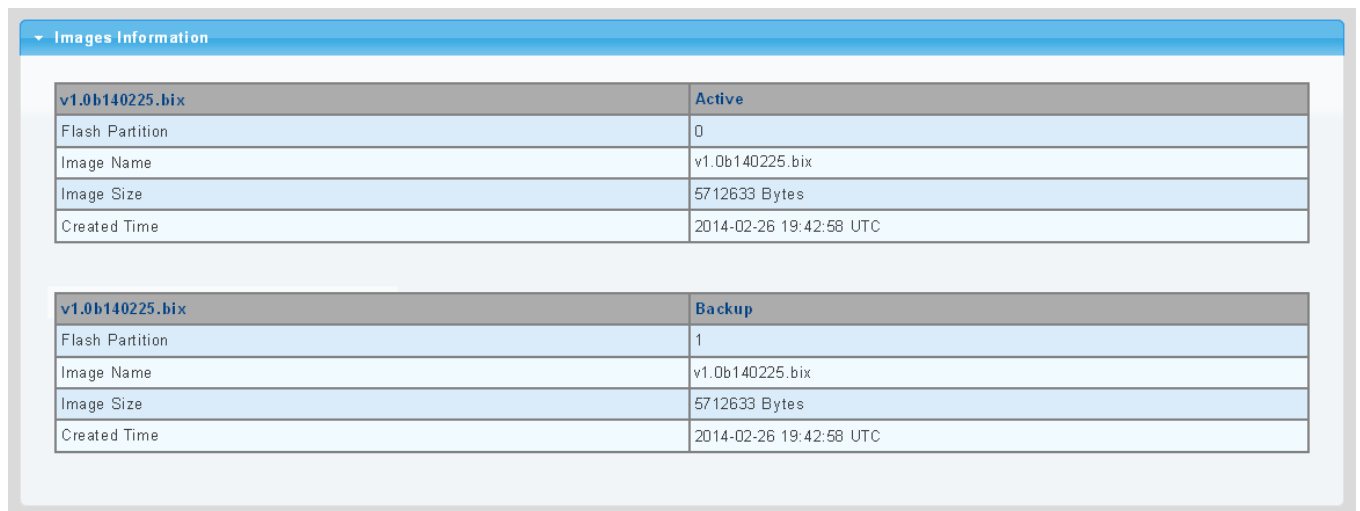

**Figure 4-16-6:** Dual Image Information Page Screenshot

The page includes the following fields:

Object	Description
<ul style="list-style-type: none"> <li>Flash Partition</li> </ul>	Displays the current flash partition
<ul style="list-style-type: none"> <li>Image Name</li> </ul>	Displays the current image name
<ul style="list-style-type: none"> <li>Image Size</li> </ul>	Displays the current image size
<ul style="list-style-type: none"> <li>Created Time</li> </ul>	Displays the created time

## 5. SWITCH OPERATION

### 5.1 Address Table

The Switch is implemented with an address table. This address table is composed of many entries. Each entry is used to store the address information of some nodes on the network, including MAC address, port no, etc. This information comes from the learning process of Ethernet Switch.

### 5.2 Learning

When one packet comes in from any port, the Switch will record the source address, port number and the other related information in the address table. This information will be used to decide either forwarding or filtering for future packets.

### 5.3 Forwarding & Filtering

When one packet comes from some port of the Ethernet Switching, it will also check the destination address besides the source address learning. The Ethernet Switching will look up the address table for the destination address. If not found, this packet will be forwarded to all the other ports except the port, which this packet comes in. And these ports will transmit this packet to the network it connected. If found, and the destination address is located at a different port from this packet comes in, the Ethernet Switching will forward this packet to the port where this destination address is located according to the information from the address table. But, if the destination address is located at the same port with this packet, then this packet will be filtered, thereby increasing the network throughput and availability

### 5.4 Store-and-Forward

Store-and-Forward is one type of packet-forwarding techniques. A Store-and-Forward Ethernet Switching stores the incoming frame in an internal buffer and does the complete error checking before transmission. Therefore, no error packets occur. It is the best choice when a network needs efficiency and stability.

The Ethernet Switch scans the destination address from the packet-header, searches the routing table provided for the incoming port and forwards the packet, only if required. The fast forwarding makes the switch attractive for connecting servers directly to the network, thereby increasing throughput and availability. However, the switch is most commonly used to segment existence hubs, which nearly always improves the overall performance. An Ethernet Switching can be easily configured in any Ethernet network environment to significantly boost bandwidth using the conventional cabling and adapters.

Due to the learning function of the Ethernet switching, the source address and corresponding port number of each incoming and outgoing packet is stored in a routing table. This information is subsequently used to filter packets whose destination address is on the same segment as the source address. This confines network traffic to its respective domain and reduces the overall load on the network.

The Switch performs "Store and forward"; therefore, no error packets occur. More reliably, it reduces the re-transmission rate. No packet loss will occur.

## 5.5 Auto-Negotiation

The STP ports on the Switch have a built-in "Auto-negotiation". This technology automatically sets the best possible bandwidth when a connection is established with another network device (usually at Power On or Reset). This is done by detecting the modes and speeds when both devices are connected. Both 10BASE-T and 100BASE-TX devices can connect with the port in either half- or full-duplex mode.

<b>If attached device is:</b>	<b>100BASE-TX port will set to:</b>
<b>10Mbps, without auto-negotiation</b>	<b>10Mbps.</b>
<b>10Mbps, with auto-negotiation</b>	<b>10/20Mbps (10BASE-T/full-duplex)</b>
<b>100Mbps, without auto-negotiation</b>	<b>100Mbps</b>
<b>100Mbps, with auto-negotiation</b>	<b>100/200Mbps (100BASE-TX/full-duplex)</b>

## 6. TROUBLESHOOTING

This chapter contains information to help you solve your issue. If the Industrial Managed Switch is not functioning properly, make sure the Industrial Managed Switch is set up according to instructions in this manual.

### ■ The Link LED is not lit

#### **Solution:**

Check the cable connection and remove duplex mode of the Industrial Managed Switch

### ■ Some stations cannot talk to other stations located on the other port

#### **Solution:**

Please check the VLAN settings, trunk settings, or port enabled/disabled status.

### ■ Performance is bad

#### **Solution:**

Check the full duplex status of the Industrial Managed Switch. If the Industrial Managed Switch is set to full duplex and the partner is set to half duplex, then the performance will be poor. Please also check the in/out rate of the port.

### ■ Why the Switch doesn't connect to the network

#### **Solution:**

1. Check the LNK/ACT LED on the Industrial Managed Switch
2. Try another port on the Industrial Managed Switch
3. Make sure the cable is installed properly
4. Make sure the cable is the right type
5. Turn off the power. After a while, turn on power again

### ■ 100BASE-TX port link LED is lit, but the traffic is irregular

#### **Solution:**

Check that the attached device is not set to full duplex. Some devices use a physical or software switch to change duplex modes. Auto-negotiation may not recognize this type of full-duplex setting.

### ■ Switch does not power up

#### **Solution:**

1. AC power cord is not inserted or faulty
2. Check whether the AC power cord is inserted correctly
3. Replace the power cord if the cord is inserted correctly. Check whether the AC power source is working by connecting a different device in place of the switch.

4. If that device works, refer to the next step.
5. If that device does not work, check the AC power

■ **Why the PoE Ethernet Switch doesn't connect to the network**

**Solution:**

Check the LNK/ACT LED on the PoE Ethernet Switch. Try another port on the PoE Ethernet Switch. Make sure the cable is installed properly and make sure the cable is the right type. Turn off the power. After a while, turn on power again.

■ **When I connect my PoE device to PoE Ethernet Switch, it cannot be powered on**

**Solution:**

1. Please check the cable type of the connection from the PoE Ethernet Switch (port 1 to port 8) to the other end. The cable should be an 8-wire UTP, Category 5 or above, EIA568 cable within 100 meters. A cable with only 4-wire, short loop or over 100 meters will affect the power supply.
2. Please check and assure the device is fully complied with IEEE 802.3af / 802.3at standard.



## APPENDIX A Switch's RJ45 Pin Assignments

### A.1 1000Mbps, 1000BASE-T

Contact	MDI	MDI-X
1	BI_DA+	BI_DB+
2	BI_DA-	BI_DB-
3	BI_DB+	BI_DA+
4	BI_DC+	BI_DD+
5	BI_DC-	BI_DD-
6	BI_DB-	BI_DA-
7	BI_DD+	BI_DC+
8	BI_DD-	BI_DC-

Implicit implementation of the crossover function within a twisted-pair cable, or at a wiring panel, while not expressly forbidden, is beyond the scope of this standard.

### A.2 10/100Mbps, 10/100BASE-TX

When connecting your 10/100Mbps Ethernet Switch to another switch, a bridge or a hub, a straight or crossover cable is necessary. Each port of the Switch supports auto-MDI/MDI-X detection. That means you can directly connect the Switch to any Ethernet devices without making a crossover cable. The following table and diagram show the standard RJ45 receptacle/connector and their pin assignments:

RJ45 Connector pin assignment		
Contact	MDI Media Dependent Interface	MDI-X Media Dependent Interface-Cross
1	Tx + (transmit)	Rx + (receive)
2	Tx - (transmit)	Rx - (receive)
3	Rx + (receive)	Tx + (transmit)
4, 5	Not used	
6	Rx - (receive)	Tx - (transmit)
7, 8	Not used	

The standard cable, RJ45 pin assignment

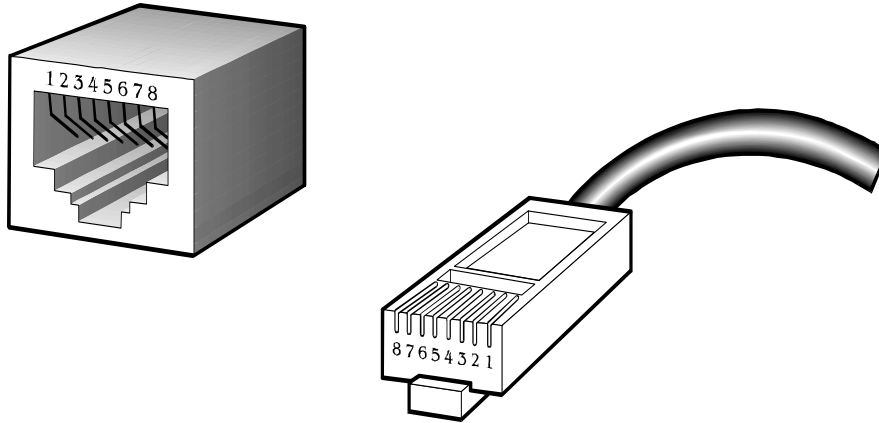

The standard RJ45 receptacle/connector

There are 8 wires on a standard UTP/STP cable and each wire is color-coded. The following shows the pin allocation and color of straight cable and crossover cable connection:

Straight-through Cable		SIDE 1	SIDE 2						
1	2	3	4	5	6	7	8	<b>SIDE 1</b> 1 = White / Orange 2 = Orange 3 = White / Green 4 = Blue 5 = White / Blue 6 = Green 7 = White / Brown 8 = Brown  <b>SIDE 2</b> 1 = White / Orange 2 = Orange 3 = White / Green 4 = Blue 5 = White / Blue 6 = Green 7 = White / Brown 8 = Brown	
1	2	3	4	5	6	7	8		
Crossover Cable		SIDE 1	SIDE 2						
1	2	3	4	5	6	7	8		<b>SIDE 1</b> 1 = White / Orange 2 = Orange 3 = White / Green 4 = Blue 5 = White / Blue 6 = Green 7 = White / Brown 8 = Brown  <b>SIDE 2</b> 1 = White / Green 2 = Green 3 = White / Orange 4 = Blue 5 = White / Blue 6 = Orange 7 = White / Brown 8 = Brown
1	2	3	4	5	6	7	8		
1	2	3	4	5	6	7	8		
1	2	3	4	5	6	7	8		
1	2	3	4	5	6	7	8		
1	2	3	4	5	6	7	8		
1	2	3	4	5	6	7	8		
1	2	3	4	5	6	7	8		

Figure A-1: Straight-through and Crossover Cable

Please make sure your connected cables are with the same pin assignment and color as the above table before deploying the cables into your network.